

Detailed instruction manual



You can find the detailed instructions at www.grundig.de under "Service".

Table of Contents

2	EU directives
3	About your TV set
3	Intended use
3	Safety
4	Environmental information
5	Packing contents
6	Setting up or hanging
7	Connections
8	Control elements
8	Multi-function switch
9	Inserting batteries into the remote control
9	Setting up the TV set
9	Adding new TV stations at a later point
9	Sorting TV stations in the channel list
10	Remote control
11	Favourites lists
11	Zapping function
11	HbbTV
12	Recording from digital TV stations
12	Watching TV with time shift
13	Media player
13	SMART inter@ctive TV 4.0
13	Web browser
14	Product data sheet
15	Licence
15	Cleaning the TV set
15	Abbreviations

EU directives



This product complies with the following EU directives:

2014 / 53 / EU 2014/30/EC, 2014/35/EC, 2009/125/EC, 2017/1369/EU and 2011/65/EU.

TV's wireless system can only be used in the countries below.



AT, BE, BG, CH, CY, CZ, DE, DK, EE, ES, FI, FR, GB, GR, HU, IE, IS, IT, LI, LT, LU, LV, MT, NL, NO, PL, PT, RO, SE, SI, SK, HR, TR.

The use of the 5150-5350 MHz band is restricted to indoor use only. (For Wi-Fi/Bluetooth built-in model or Wi-Fi Built-in model).

This device can also be operated in the countries outside Europe.

About your TV set

- With your TV set, you can receive and watch digital TV programmes over DVB-S, DVB-T and DVB-C, along with analogue TV.
- Many features of the TV set require an Internet connection. The TV set is equipped with WLAN and a LAN port.
- The TV set can record programmes. For this feature you need a USB storage device, such as an external hard drive (not included). Recorded programmes can only be played on the same TV set. After the TV set is repaired, it is possible that recorded programmes may no longer be able to be played back.
- You can connect various data media, for example, an external hard drive, a USB memory stick or a digital camera to the USB sockets. Using the file browser, you can then select and play the file formats you want (for example, MP4, MP3 or JPEG data).
- With the Time Shift function, you can easily stop and resume a programme with the remote control in a fast and simple way. Programme is recorded to the external data medium.

Intended use

- The TV set is designed for use in dry rooms.
- Use the TV set with the supplied stand or a suitable VESA bracket.
- The TV set is primarily intended for the playback of TV programmes, streaming content and audio/video material from external devices. Any other use is strictly prohibited.

It is not intended as an information display or for predominant use as a computer monitor. If a still image or a non-full-format image is displayed for an extended period, visible traces may remain on the screen for some time.

This is not a defect that can be used as the basis for a warranty claim.

Safety

▲ WARNING

Risk of electrical accident

- Do not open the TV set. Safety risk may arise and also the guarantee of the product can be void if the television set is opened.
- The TV set can only be operated with the power cable or the AC/DC adapter supplied with the product.
- Do not operate the TV set with a damaged power cord/AC/DC adaptor (if supplied).
- If the plug on the TV set has an earthing contact, only insert the plug into a socket with an earthing contact.
- Plug the TV set into the mains socket only after you have connected the external devices and the antenna.
- Protect the TV set from moisture. Do not place any vessels filled with water (such as vases) on the TV.

Fire hazard



To prevent the spread of fire, keep candles or other open flames away from this product at all times.

- Do not cover the ventilation slots on the TV set.
- Always unplug the power plug and antenna plug during a thunderstorm.
- Keep candles or other open flames away from the TV set.
- Do not expose the batteries to extreme heat such as sunshine, fire or the like.
- Only use batteries of the same type (brand, size, properties). Do not use used and new batteries together.

▲ WARNING

Injuries caused by falling TV set

Never place the TV set on an unstable surface. The TV set may fall, causing serious injury, possibly leading to death in isolated cases.

Observe the following precautions:

- Only use the manufacturer's recommended cabinets or stands.
- Only use furniture that can safely support the TV set.
- Make sure that the TV set does not protrude beyond the dimensions of the furniture on which it is resting.
- Do not place the TV set on tall furniture (such as kitchen cabinets, bookshelves) without securely anchoring the furniture and TV set.
- Do not place the TV set on fabric or other materials located between the TV set and furniture.
- Instruct children that there is danger associated with climbing on furniture when the TV set is to be reached.

NOTICE

Shortened service life due to high operating temperature

- Do not place the TV set next to heating units or in direct sunlight.
- To ensure adequate ventilation, maintain clearance of at least 10 cm around the TV set.



Discolouration of furniture due to rubber feet

- Some furniture surfaces may discolour when they come in contact with rubber. To protect furniture, you can place a sheet made of glass or plastic under the stand. Do not use textile underlays or mats such as doilies.

Electromagnetic noise

- Devices connected to the product (satellite receiver, DVD player, and etc.) or signal emitting devices (router and etc.) close to the product may cause disturbance in the image and noise in the sound.
- Connection cables used on the product must be shorter than 3 m.
- If the product cannot perform its function due to electrostatic discharge, the user may need to switch off and then switch on the product.
- A shielded, HDMI-certified and ferrite cable must be used with the product.

Environmental information

-  Do not dispose of batteries in the household waste. Used batteries must be returned to retail stores or public collection points. You help to protect the environment in this way.
- Be sure to dispose of packaging materials for your product separately according to the guidelines of local authorities so that they can be recycled in an environmentally safe manner.
- If you are not using your TV set for a while, turn it to standby mode. In standby mode, the TV set uses very little energy (≤ 0.5 W).
If you do not use the TV set for an extended period, turn it off with the power switch or unplug the power cord from the socket. If you turn off the device or disconnect it from the power supply, the switch-on timer and programmed recordings will not work.
- Select a location for the TV set so that no direct sunlight falls on the screen. This allows a lower backlight to be selected, which saves energy.
-  Do not dispose of the product along with normal household waste at the end of its service life. Take it to a recycling centre for electrical and electronic equipment.

Packing contents

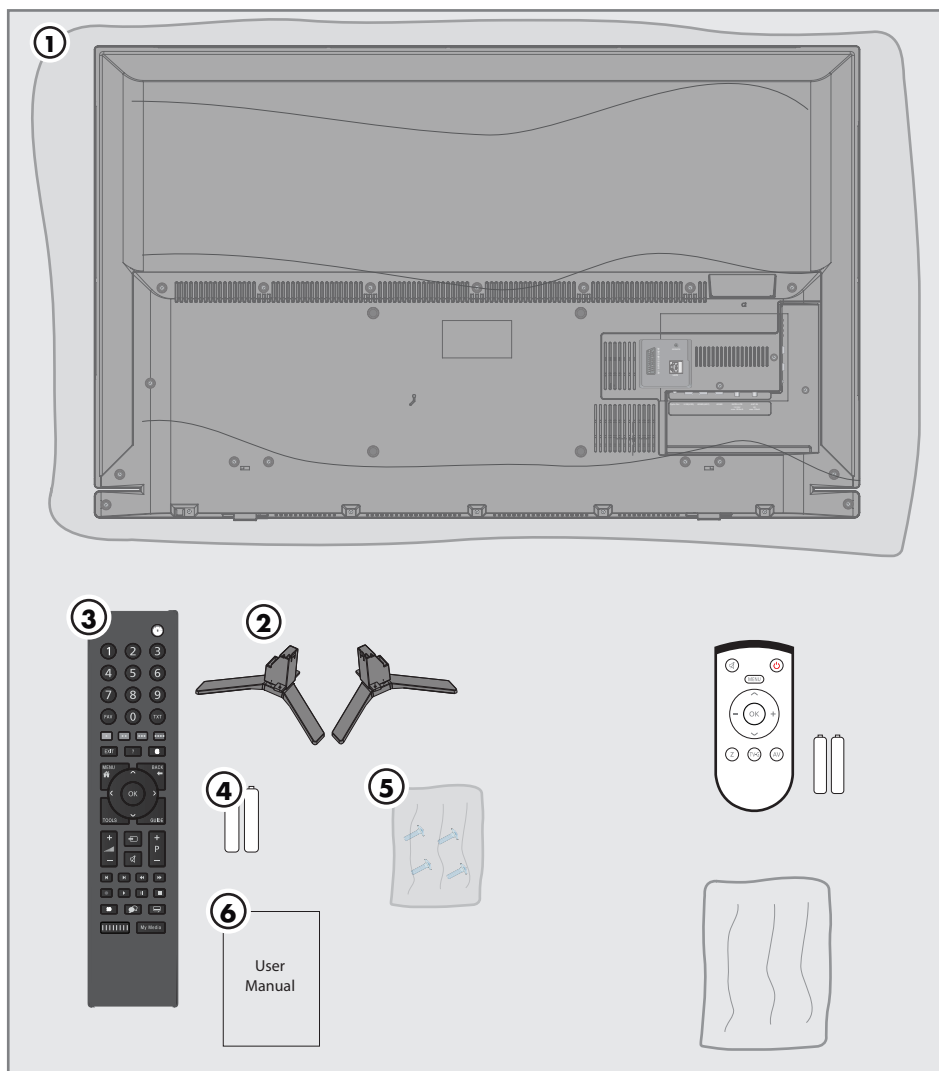

Standart accessory

1. TV
2. Stand
3. Remote control
4. Batteries for remote controls
5. Screws and mounting instructions for stand
6. Brief Instruction

Optional accessory

- Easy-Use Remote Control
- Batteries for Easy-Use remote controls
- Cleaning cloth
- Screws for VESA bracket

Setting up or hanging

- Select a location so that no direct sunlight falls on the screen.

Setting up with stand

- To mount the stand, refer to the installation instructions included.
- Place the TV set on a hard, level surface.

Preparing for mounting on the VESA bracket

You will need:

- A pair of scissors,
- A crosstip screwdriver.

Follow the installation instructions for the VESA bracket.

1. Place the TV set in the film on a smooth surface with the screen facing down.
2. Cut open the film on the back side using the scissors.
3. Connect the required cables to the connectors on the TV set. See the "Connections" section in this manual.
4. Tie the cables so they do not hang down onto the floor.
5. Screw the VESA bracket onto the TV set and mount it according to its installation instructions.

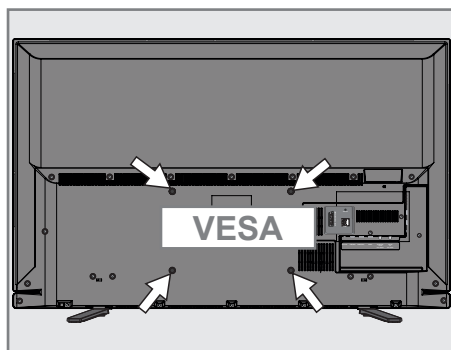

Connections

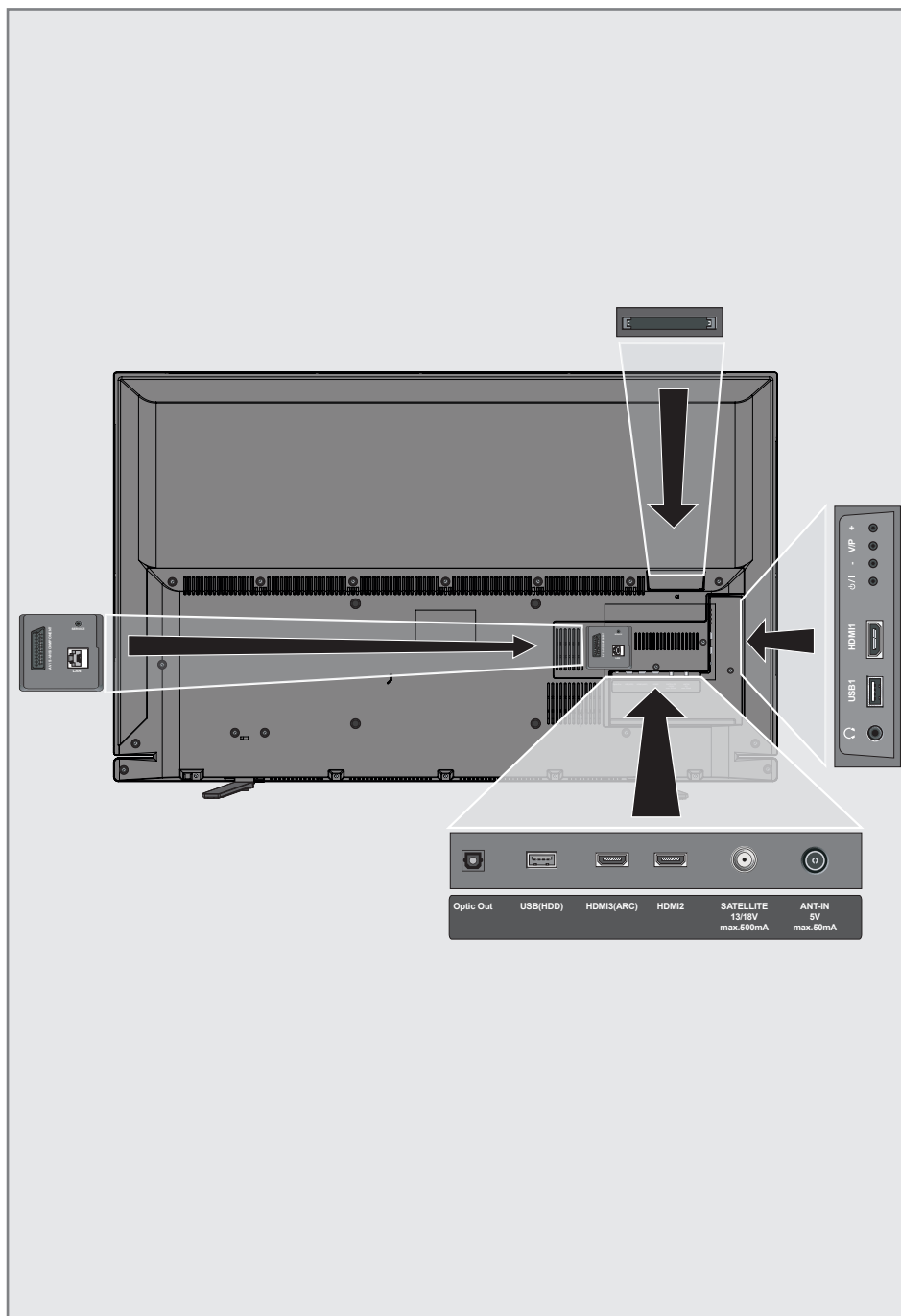

- **LAN:** Network connection
- **AV / S-VHS / COMPONENT:**
 SCART socket, audio/video input and output
 S-VHS socket, audio/video input for S-Video camera using a SCART-S-VHS adapter cable.
 Component socket, audio/video input (YUV signal) using a SCART-YPbPr adapter cable.
- **SERVICE:** Service only.
- **Optic Out:** optical audio output
- **USB(HDD):** connect data media for recording programmes, such as an external hard disk.
- **HDMI3 (ARC):** Input for digital audio and video data with audio return channel.
- **HDMI2:** Input for digital audio and image data.
- **SATELLITE:** for satellite antenna. Suitable for single-cable GSCR system.
- **ANT IN:** for antenna cable (terrestrial antenna or cable connection).
- **Ω:** Headphone jack or line output via adapter.
- **USB1:** for data media or keyboard.
- **HDMI1:** Input for digital audio and image data.
- **CI:** for CA modules for receiving encrypted stations.

Control elements

- **V/P:** Multi-function switch

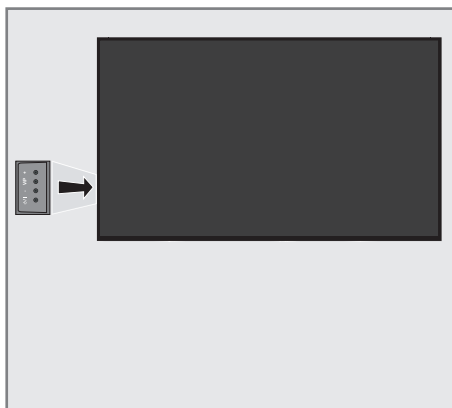

Multi-function switch

Switching on the TV

1. **⏻/I** Switches the television on and back into standby mode.

Turning the TV to standby

1. Press the multi-function switch.
2. Rock until "Switch to standby" is selected.
3. Press.

Adjusting the volume or changing the station

1. Press the multi-function switch.
2. Rock to select the required function.
3. Press.
4. Rocking now performs the selected function.

Inserting batteries into the remote control

1. Open the battery compartment.
2. Insert batteries as marked on the bottom of the battery compartment (2 × Micro/R03/AAA).
3. Close the battery compartment.

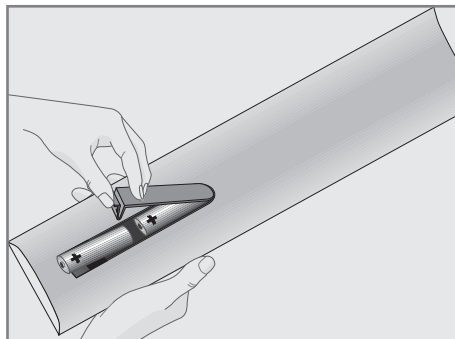





Setting up the TV set

1. Connect the cables.
2. Insert the power plug into the socket.
3. Switch on the power switch.
4. Switch on the TV set with  on the remote control.
5. Follow the setup wizard on the screen.

Adding new TV stations at a later point

1. Press .
2. Select »Settings«.
3. Select »Source«.
4. Select »Automatic Channel Search«.
5. Select the antenna type.
6. The next procedure depends on the selected antenna. Follow the instructions on the screen.

Sorting TV stations in the channel list

1. Press .
2. Press .
3. Choose the TV station you want to move, and highlight it with .
4. Press .
5. Use the navigation keys to move the TV station to the new position and confirm with .

Remote control

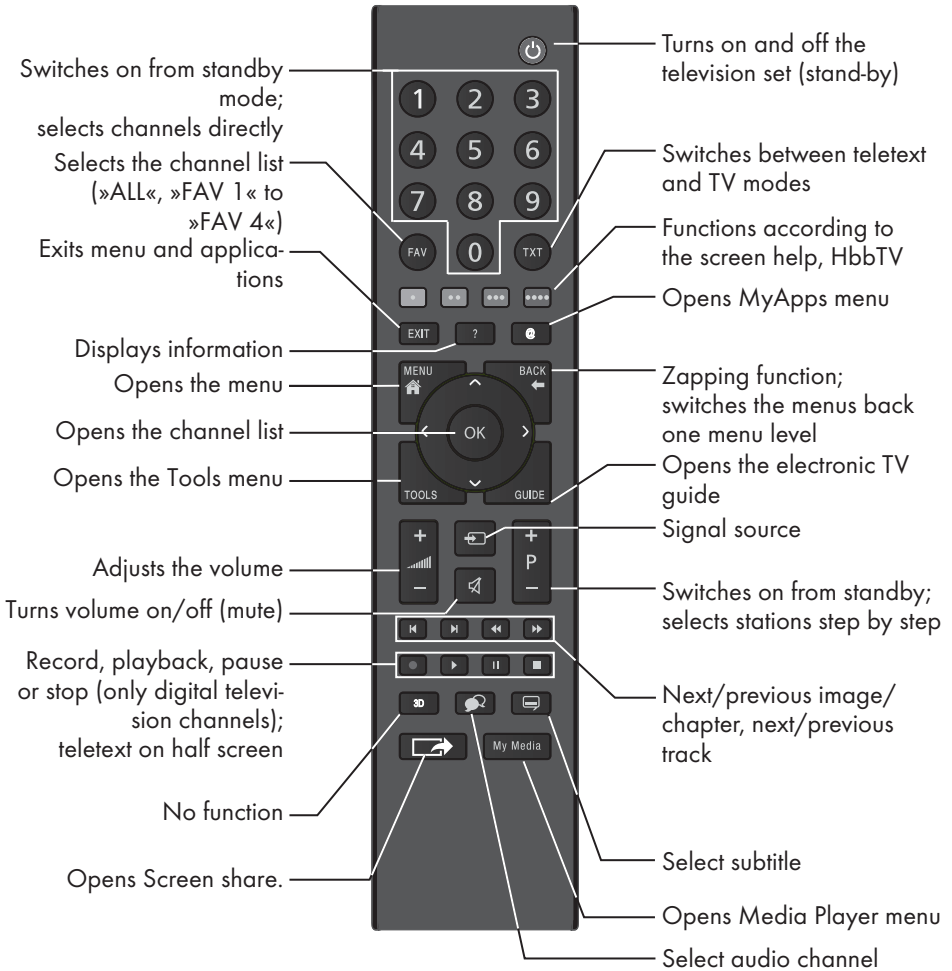

Cursor Control



Moves the cursor up and down in the menus.

Moves the cursor left/right in menus.

Opens channel list;
activates various functions.



Favourites lists

You can organise TV and radio stations in favourites lists.

Saving a station to the favourites list





1. Press .
2. Press .
3. Select the favourites list and confirm with .

Opening the favourites list

1. Press .
2. Select the favourites list and confirm with .
 - Now only stations that are stored in the selected favourites lists are available.

Zapping function

This function allows you to save a station to which you want to return during frequent changes of the station (zapping).

1. Press  to save the current station.
2. Select other stations (zapping).
3. Press  to switch to the station on which  was most recently pressed.
4.  terminates the function.

HbbTV

HbbTV is the interactive successor to teletext, with content in modern design, high-resolution images and video sequences.

For full functionality of HbbTV, the TV must be connected to the Internet.



After you switch to a TV station that offers HbbTV, a corresponding message appears.

1. Turn on HbbTV with the colour key that appears after you switch to the TV station.



Recording from digital TV stations

Recording and playback of programmes can only be carried out using an external data medium (hard drive or USB stick).

Direct recording

1. Press  to record the current programme.
2. Press  to stop recording.



Programming a recording

1. Press  to display the programme guide.
2. Select the required programme.
3. Press  to programme the recording of the broadcast.

Editing the list of scheduled recordings





1. Press .
2. Select »Schedule List«.

Tips

- To start the recording, switch the TV set to the corresponding station. A few seconds before the station is switched, a message appears. You can cancel the switching and the recording select »No« with  or  and pressing .
- The option of recording and playback of recordings may be limited by the station provider.
- External hard drives that require ≥ 500 mA of current may only be connected to sockets **USB(HDD)**.
- For one hour of recording, you need 2.6 to 6.6 GB of storage space.
- Recorded programmes can only be played back on the same TV set.

Watching TV with time shift

For this function, you need an external data medium.

1. Press  to pause the current programme.
2. Press  to continue the programme.
3. Press  /  for fast rewind/fast forward.
4. Press  to return to the current programme.



Tips

- The time shift can be up to one hour.
- The option of watching TV with time shift may be restricted by the station.



Media player

The media player displays images and plays recorded programmes, films and music. Films, music and images can be stored on a connected USB device or be provided by a DLNA media server.



Playing media

1. Press .
2. Select media source. To play TV recordings on the external data medium, select »PVR«.
3. To display image or music files: Select on the top left, then »All«, »Music« or »Photos«.
4. Navigate to the file or recording and press .

Tips

- When playing films and images, press  on the remote control to display buttons.
- Music can be played with images. During the playback of images, press  and select .
- Films can be played with subtitles. The file name of the subtitle file must be identical to the file name of the film file. Both files must be in the same folder. Subtitles in the format .SRT, .SUB, .ASS, .SSA, .SML are supported.



Turning on the display of subtitles:

1. During playback of a film, press .
2. Select Subtitles with .
3. Enable subtitles with .

SMART inter@ctive TV 4.0

SMART inter@ctive TV offers apps that allow you to conveniently use various Internet services. Some apps are already installed on the TV. You can install others from the GRUNDIG APPLICATION store.

Opening installed apps

1. Press  on the remote control.
2. Select the app and launch it with .

Opening the GRUNDIG APPLICATION store

1. In the »My Apps« menu, select the »Online Store« option on the top right.

Web browser

Launching the web browser

1. Press .
2. On the menu bar, select the »Web Browser« option.

GRUNDIG 49 VLE 6721 BP

Product data sheet

Energy efficiency class

A+

Screen diagonal

123 cm/49 inch

Power consumption

Operation 67,1 W/115 W max.

Standby 0,30 W

Networked standby 2,90 W

Annual power consumption

98 kWh

Maximum resolution

1920 × 1080

Additional information

Operating voltage:

220 ... 240 V~, 50 ... 60 Hz

Screen (dm²)

65 dm²

RoHS limits

Pb (lead)/Hg (mercury)

Pb concentration complies with RoHS limits/

0 mg

Peak luminance ratio

65%

Audio output

2 × 20 W music power

2 × 10 W sine power + 10 W sine power of the subwoofer

The subwoofer is optional and therefore not available on all products.

Default satellites

20

LNB power supply

13/18 V, 14/19 V optional, maximum

500 mA

LNB switching signal

0/22 kHz 650 mV +/- 250 mVpp

DiSEqC

1.0-operation, 1.1-operation, 1.2-operation

Digital reception ranges

Satellite

Ku band: 10,700 MHz ... 12,750 MHz

Modulation: DVBS QPSK, DVBS2 QPSK, 8 PSK

IF band: 950 MHz ... 2150 MHz

Signal level: -25 dBm ... -65 dBm

Cable

Overall band: 110 MHz ... 862 MHz

Modulation: 16 QAM, 32 QAM, 64 QAM, 128 QAM and 256 QAM

Symbol rate: 4.0 Msym/s ... 7.2 Msym/s

Terrestrial (DVB-T)

VHF/UHF-Band, bandwidth 7 MHz and 8 MHz

FFT size: 2 k, 8 k

Modulation: 16 QAM, 64 QAM, QPSK

Guard interval: 1/4, 1/8, 1/16, 1/32

Terrestrial (DVB-T2)*

VHF/UHF-Band, bandwidth 7 MHz and 8 MHz

FFT size: 1 k, 2 k, 4 k, 8 k, 16 k, 32 k

Modulation: 16 QAM, 64 QAM, 256 QAM, QPSK

Guard interval: 1/4, 19/256, 1/8, 19/128, 1/16, 1/32, 1/128

* DVB-T2 is optional and therefore not available on all products.

Analogue reception ranges

C02 ... C80, special channels S01 ... S41

Preset channels

TV/Radio 6000 (satellite - DVB-S), 1000 (cable - DVB-C)

or 99 (analogue)

1000 (terrestrial - DVB-T) or

99 (analogue)

6 AV, 2 USB

Supported media files

Image files: jpg/jpe, bmp, png

Music files: m4a, aac, mp3, wav

Video files: mov, xvid, mpg, mpe, vob, dat, trp, ts, avi, mp4, mkv

Weight

approx. 11,6 kg

Dimensions

W × H × D 110,5 cm × 68,2 cm × 7,6 cm

Technical changes and errors reserved.

Licence

For DTS patents, see <http://patents.dts.com>. Manufactured under license from DTS Licensing Limited. DTS, the Symbol, & DTS and the Symbol together are registered trademarks and DTS TruSurround is a trademark of DTS, Inc. © DTS, Inc. All Rights Reserved.

For DTS patents, see <http://patents.dts.com>. Manufactured under license from DTS Licensing Limited. DTS, the Symbol, & DTS and the Symbol together are registered trademarks, and DTS 2.0+Digital Out is a trademark of DTS, Inc. © DTS, Inc. All Rights Reserved.

Dolby, Dolby Audio, and the double-D symbol are trademarks of Dolby Laboratories.

Explanation of the symbols which may be present on back side of the television set

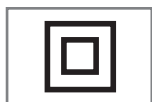

Class II or Double insulation. Television set doesn't require connection to electrical earth (ground).



Alternating current. The set works only with AC line voltage in your household electricity.



Direct current. The set works only with AC/DC adapter.

Network interfaces

This product is intended for connection to the ADSL network.

Cleaning the TV set

Pull the power cord out of the mains socket. Clean the appliance with a damp cloth and a mild detergent. Do not use any detergents containing alcohol, spirit, ammonia or scouring agent.

Use a damp, soft cloth to clean the screen. Do not use water with soap or detergent.

Abbreviations

- ARC: Audio return channel, transmits sound from the TV via an HDMI connection.
- AV: Audio/video.
- CAM: Module for receiving encrypted TV channels.
- CI: Slot for modules for receiving encrypted TV channels.
- DLNA: Organisation that develops standards for networking home devices and certifies devices and software.
- GSCR: Grundig Sat Channel Router. Technology that allows multiple TVs to be connected to a satellite antenna using a single-cable system.
- HbbTV: Standard for information and services that are offered with the TV signal as well as by the Internet, an additional service offered by some broadcasting stations.
- HD: Collective term for high-resolution audio/video data, usually 720 or 1080 lines.
- HDMI: Connection for high-resolution digital audio/video data.
- LAN: local area network.
- VESA: Organisation that has developed a standard for the attachment of screens.
- WLAN: wireless local area network.