

Hisense

LASER TV 4K



USER MANUAL

Read the manual carefully and ensure you have fully understood its contents before operating this device for the first time.

English

Important Notice

Paragraphs beginning with the symbol  indicate important instructions, tips or conditions for the following settings.



For your own safety and the optimal performance of your device, ensure to read the safety instructions before performing any installation.

Compatibility with 3rd party products, software and services are not guaranteed. We cannot be held liable for any damage or loss suffered whilst operating, using or connecting to incompatible devices or apps.

The recording and playback of content on this or any other device may require permission from the owner of the copyright or other such rights in that content. It is your responsibility to ensure that your use of this or any other device complies with applicable copyright legislation in your country. Please refer to that legislation for more information on the relevant laws and regulations involved or contact the owner of the rights of the content you wish to record or playback.

Read these instructions

Follow all instructions

Heed all warnings

Keep these instructions

All rights reserved.



Safety Instructions

To ensure safe and correct use of this product, always comply with the following precautions to avoid dangerous situations and damage to your unit:

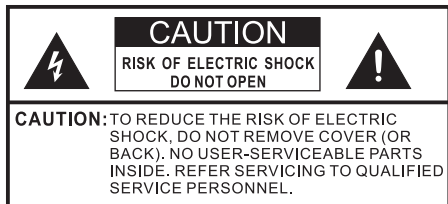

The lightning flash with arrowhead symbol, within an equilateral triangle is intended to alert the user to the presence of uninsulated dangerous voltage within the product's enclosure that may be of sufficient magnitude to constitute a risk of electric shock.



The exclamation point within an equilateral triangle is intended to alert the user to the presence of important operating and maintenance (servicing) instructions in the literature accompanying the appliance.

The intended use and ambient conditions for this device

This device is intended for the rendering of video and audio signals, on a table-top, in a home or office environment. It must not be used in rooms with a high level of humidity or dust concentration. The warranty is only valid if used as intended by the manufacturer.



High humidity and dust concentration may lead to current leaks in the device. To reduce the risk of fire or electrical shock:

- Do not expose this unit to rain, moisture, dripping or splashing water, and do not place objects filled with liquids, such as vases, cups, etc. on or over the unit.
- Do not touch the device with wet hands.
- Do not expose to direct air-conditioning and keep candles or other naked flames away from the device at all times.

If the device is moved from a cold environment to a hot environment, leave it switched off for at least an hour to avoid condensation. If used outside, make sure it is protected from moisture.

If you notice anything unusual, immediately remove the power plug.

In case of fire, use preferably a CO₂ gas or powder fire extinguisher. If such extinguishers are not accessible, try to isolate the electrical supply before using a water fire extinguisher.

Never place a television set in an unstable location. A television set may fall, causing serious personal injury or death. Many injuries, particularly to children, can be avoided by taking simple precautions such as:

- Using cabinets or stands recommended by the manufacturer of the television set.
- Only using furniture that can safely support the television set.
- Ensuring the television set is not overhanging the edge of the supporting furniture.
- Not placing the television set on tall furniture (for example, cupboards or bookcases) without anchoring both the furniture and television set to a suitable support.
- Not placing the television set on cloth or other materials that may be located between the television set and supporting furniture.
- Educating children about the dangers of climbing on furniture to reach the television set or its controls.

If your existing television set is being retained and relocated, the same considerations as above should be applied.

■ Power Supply

Incorrect voltages can damage the device. Only connect this unit to a power supply with the correct voltage and frequency noted on the type plate, using the supplied power cable.

The power plug must be easily accessible so that the device can be disconnected at all time. The unit is live, even if in standby mode, as long as the unit is connected to a power outlet.

It is recommended that this unit is placed on a dedicated circuit.

- Do not overload the power outlets by connect too many appliances to the same outlet. Overloaded wall outlets, extension cords, etc. are dangerous and can result in electric shock and fire.

After power off, don't turn it on again in 5 seconds. Frequent switching power supply in a short period of time can cause abnormal device.

■ Power plug and power cable

- Do not touch the power plug with wet hands.
- Do not place heavy objects on the power cable. Route the cable so that it is not kinked or laid over sharp edges, walked on or exposed to chemicals. A power cable with damaged insulation can cause electric shock and fire.
- Pull the power plug, NOT on the cable when disconnecting. The cable can become damaged and cause a short circuit if pulled on.
- Do not place the power cable near a high temperature object.
- Do not move the device with the power cable plugged into a socket.
- Do not use a damaged or loose power cable, or a damaged socket outlet.
- Do not use any power cords other than the one supplied with this unit.

■ Air ventilation and high temperatures

Install your device only where there is proper ventilation, and ensure that there is at least 20 cm free space on the sides and 15 cm free space on the back unit for air circulation. Excessive heat and obstruction of ventilation could lead to fire or early failure of some electric components.

- Do not block any ventilation openings with newspapers, tablecloths, curtains, etc.
- Do not dry clothing etc. on top of the unit.
- Take care not to touch the ventilation openings since they may

become hot.

- Do not insert foreign objects into the device through the vents.

■ Warning about off-gassing

New furniture, carpet, paint, building materials and electronics can release chemicals into the air through evaporation. After you set your device up and turn it on for the first time, you may notice a slight smell within a couple of hours. This is because some components of device are heating up for the first time. The materials that we use fully meet the environmental requirements and regulations. Your device is working just fine and the fumes from the off-gassing will diminish eventually.

■ Supervision

- Do not let children play unsupervised close to the device. It could tip over, be pushed off or pulled down from the stand surface and injure someone.
- Do not allow a switched-on device to run unattended.

■ Volume

Loud music and noises can lead to irreversible damage to your ears. Avoid extreme volume, especially over long periods and when using headphones.

If you hear a drumming noise in your ears, turn down the volume or temporarily stop using headphones.

■ Thunder Storms

Pull out the power plug and all connected antenna cables from the device during a thunderstorm. Overvoltage caused by lightning strikes can damage the device via the antenna system, as well as the wall socket.

■ Long periods of absence

As long as the power plug is connected to a live socket outlet, the device will consume power even in standby mode. The power plug and all connected antenna cables should be disconnected out during long periods of absence.

■ Cleaning and care

CAUTION:

Unplug the power cord prior to cleaning the device.

Clean the device, the screen, and the remote control with a soft, moist, clean and color-natural cloth only. Do not use any chemicals.

- Do not subject the surfaces to insect repellent, solvent, thinner or other volatile substances. This may degrade the surface quality.
- Do not spray water or other liquids directly on the device. Liquid inside the device could lead to product failure.
- The surface of the display panel is treated and may be easily damaged. Take care not to scratch it with fingernails or other hard objects.

- Also wipe the power plug with a dry cloth at regular intervals.

■ Service/Repair

Never remove the cover/back of the device; there are no user serviceable parts inside. Refer all service to qualified service personnel.

■ Packaging

Keep the anti-moisture materials and plastic bags out of reach of children.

Plastic bags can cause suffocation and the anti-moisture material is harmful if swallowed. If swallowed by mistake, force the patient to vomit and visit the nearest hospital.

■ Modification

Do not attempt to modify this product in any way. Unauthorized modification could void the warranty of this unit, cause electric shock and fires.

■ Remote Control batteries

- Incorrect installation may cause battery leakage, corrosion and explosion.
- Replace only with the same or equivalent type.
- Do not mix old and new batteries.
- Do not mix different battery types.

- Do not use rechargeable batteries.
- Do not burn or break up batteries.
- Be sure to dispose of batteries correctly.
- Do not expose batteries to excessive heat such as sunshine, fire or the like.

■ Outdoor Antenna Grounding

If an outdoor antenna used, be sure the antenna system is protected against voltage surges and built-up static charges.

■ Disposal

Refer to the recycling section of this manual.

■ Laser

Do not look directly at the lens when this device is on because the laser light may damage your eyes!

- This product comes with a laser module. Do not tear or modify this device in any manner; otherwise, it may result in personal injury.

RG2

As with any bright light source, DO NOT STARE INTO THE BEAM IEC 62471-5: 2015

CLASS 1 LASER PRODUCT

$\lambda = 459\sim 471\text{nm}/519\sim 531\text{nm}/635\sim 651\text{nm}$

Wavelength 459~471nm/519~531nm/635~651nm

CLASS 1 LASER PRODUCT

IEC 60825-1: 2014

CAUTION:

Use of controls or adjustments or performance of procedures other than those specified herein may result in hazardous radiation exposure.

- If this device requires a repair, please wear laser eye protection with an optical density OD that is 4 or higher and has a wave length of 459-651 nm.
 - Do not place any water-containing vessel on this device, such as cosmetics or liquid medicine.
 - If any object or water enters this device, please unplug this device and contact the service staff of Hisense.
 - Do not place any exposed fire source (e.g. burning candle) on this device. Keep away from high temperature and heat.
 - Do not expose the battery to direct sunlight or candle light.
 - Keep air vents on both sides clear from any objects to prevent the device from overheating inside.
- To avoid a short circuit, product damage or electric shock, do not use any sharp object or metal to touch the ports or other openings on the TV.
 - If this device has been in a warm environment, allow any built-up condensation to evaporate first BEFORE you switch the device on.
 - Do not allow a child to stand on or climb up this device.
 - Do not place any object above or in front of the lens because the laser light could cause the object to become flammable.
 - Clean the lens periodically with a clean cloth and make sure the TV is turned off before you start.



AC voltage: This symbol indicates that the rated voltage marked with the symbol is AC voltage.



Class II product: This symbol indicates that it does not require a safety connection of protective earthing (ground).

Congratulations on the purchase of your new TV! This Manual will walk you through a few easy steps to set up your TV.

Please visit Hisense official website for more details.

Product image is only for reference, actual product may vary in appearance.

Parts of the software function changes with the system upgrade.

Table of Contents

Accessories List	2
Laser TV Diagram	3
STEP 1. Mount the Screen	4
STEP 2. Install the Laser TV	4
STEP 3. Adjust the Display Image and the Screen	9
STEP 4. Use Your Remote	13
STEP 5. Proceed through the Screen Setup Menu	16
STEP 6.TV Setup	17
Maintenance & Quick Problem-Solving Tips	18
Product Specifications	20
Recycling / Licenses	22

- Do not allow a child to stand on or climb up this device.
- Do not place any object above or in front of the lens because the laser light could cause the object to become flammable.
- Clean the lens periodically with a clean cloth and make sure the TV is turned off before you start.

Accessories List

- Laser TV × 1
- Remote control × 1
- AAA batteries × 2
- Gloves for handling the Laser TV × 2
- Power cord × 1
- Wrench to adjust the bottom of the TV × 1
- USB extension cable × 1
- Laser TV User Manual × 1
- Laser TV European Guarantee × 1
- Cleaning kit for the lens × 1
- 2 C-shape blocks
- C-shaped Block Installing Instruction
- RCA Jack to AV Cable × 1

Additional items that come with the TV in a separate package

- A Display Screen (optional equipment)*
- A set of Wall Mount Brackets (optional equipment)*

* Additional items you receive will be based upon your order.

NOTE: The accessories may be different from the list above due to different models, countries/regions. Please refer to the actual accessory bag.

Laser TV Diagram

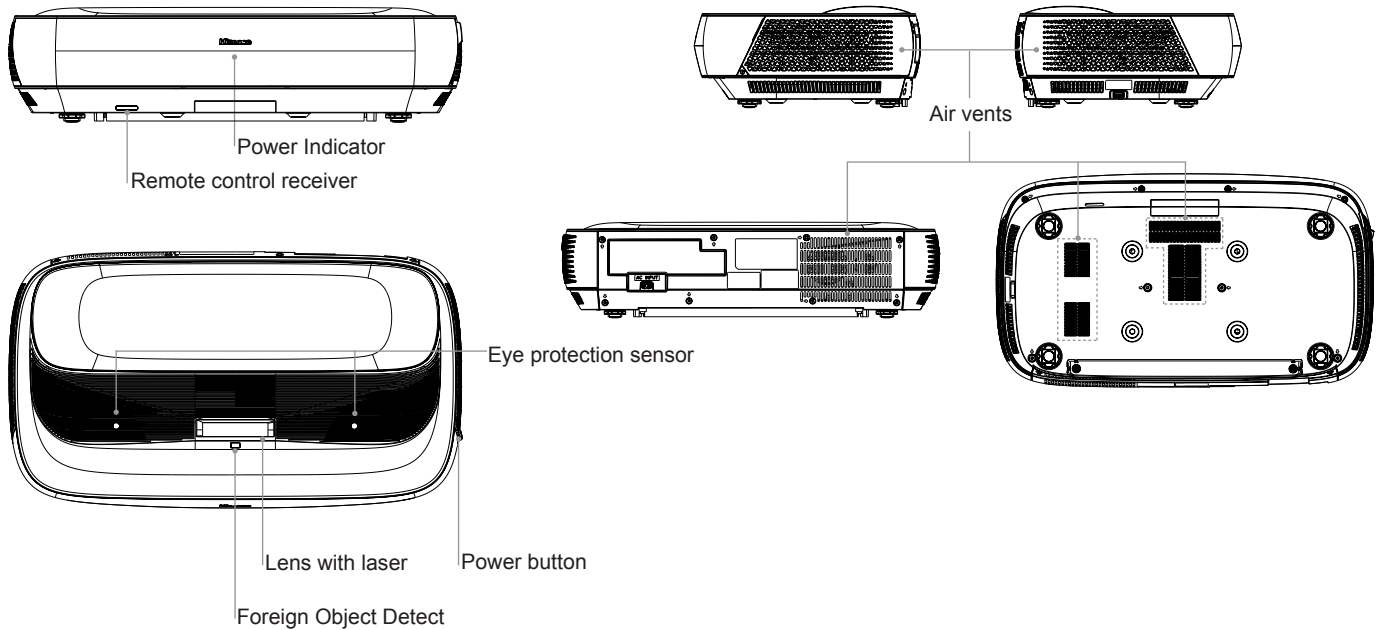

We strongly recommend that two people handle this device when moving it from one place to another. Be sure to protect the lens when you handle this device.

STEP 1 Mount the Screen

Screen installation please refer to the specific screen installation guide!

STEP 2 Install the Laser TV

We strongly recommend that two people handle this device when moving it from one place to another. Be sure to protect the lens when you handle this device.

We recommend to connect all cables to the ports on the back of the Laser TV before positioning the TV. (Audio, video, Ethernet cables and external devices are not included.)

Check to ensure that you have selected the right cables for the ports and that they are connected securely. Loose connections can affect the quality of the picture image and colour.

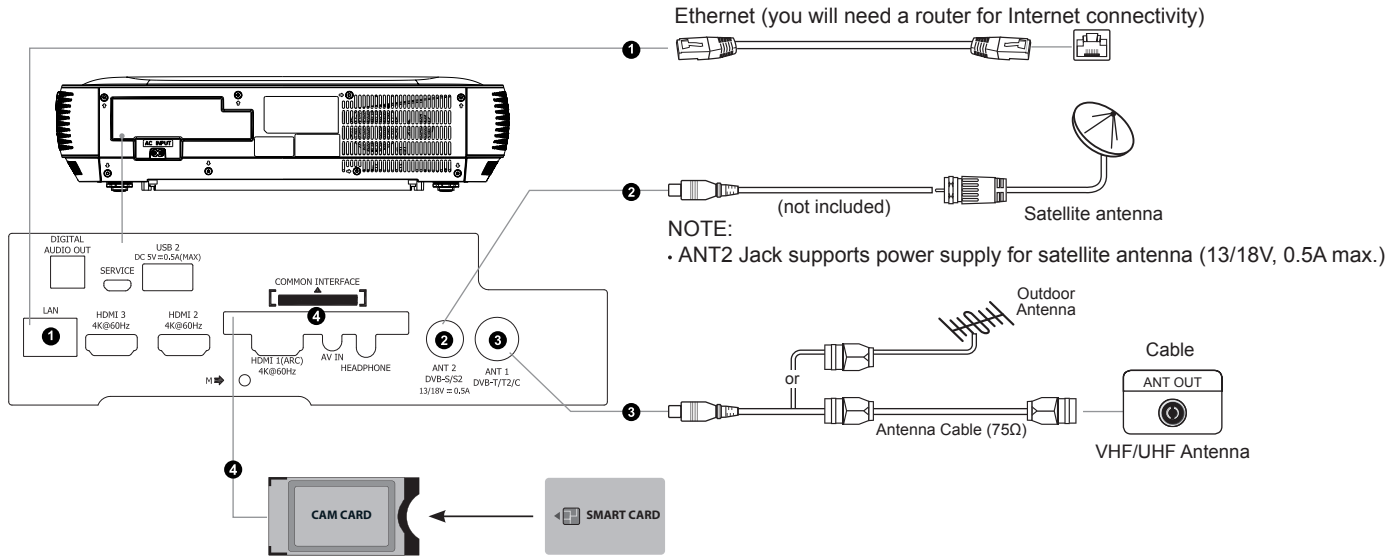

NOTE:

- Before you insert/remove the CI+ module, ensure that the TV is switched off. Then insert the CI card into the CI+ module in accordance with the Service Provider's instructions.
- Do not repeatedly insert or remove the Common Access Module as this may damage the interface and cause a malfunction.
- You must obtain a CI+ module and card from the service provider of the channels you want to watch.
- Insert the CI+ module with the SmartCard in the direction marked on the module and SmartCard.
- CI+ is not supported in some countries and regions; check with your authorized dealer.

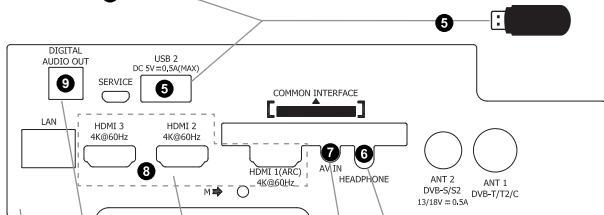
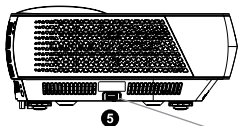

NOTE:

- When connecting a hard disk or a USB hub, always connect the mains adapter of the connected device to the power supply. Exceeding a total current consumption may result in damage. The USB1.1 and USB2.0 devices maximum current consumption are 500mA.
- For individual non-standard high-capacity mobile hard disk, if its impulse current is greater than or equal 1A, it may cause TV-rebooting or self-locking. So the TV does not support it.
- The USB port supports a voltage of 5V.
- Use the USB extension cable (included) for easier connection and disconnection.

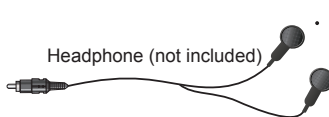

- Excessive sound pressure from earphones and headphones can cause hearing loss.

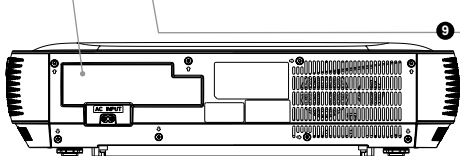
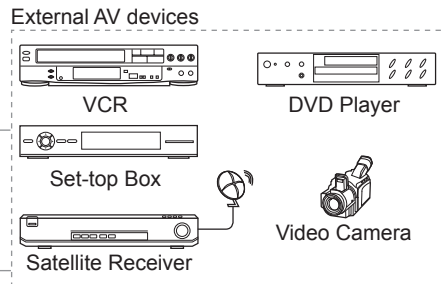
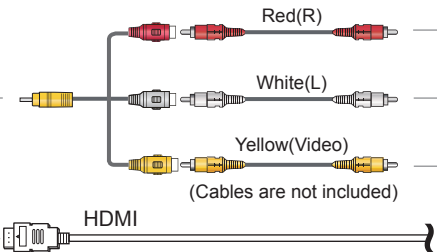

External audio devices

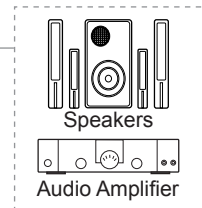

LAN (Wired setup)

- Connect your TV to your network by connecting the LAN port on the back of your TV to an external modem or router using a LAN (Ethernet/Cat 5) cable. See the illustration below.

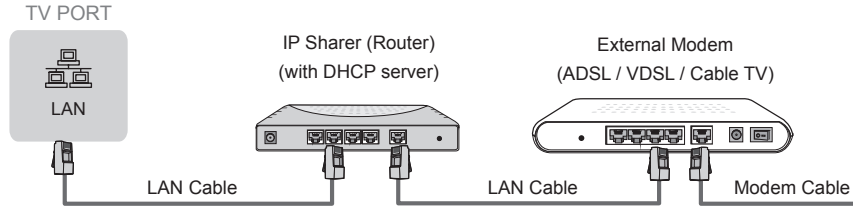

Wireless setup

- Connect your TV to your network wirelessly, you need a wireless router or modem. See the illustration below.



NOTE:

- You must use the built-in Wireless LAN Adapter to use a wireless network because the set doesn't support external USB network adapters.
- If the wireless router supports DHCP, your TV can connect more easily to the wireless network.
- If you apply a security system other than the systems listed below, it will not work with the TV.
security system: WPA, WEP, WPA2.
- In order to guarantee smooth network, the distance between router and TV should be less than 10 metres.

Plug the power cord into a wall outlet.
Press the POWER button to turn on the Laser TV.

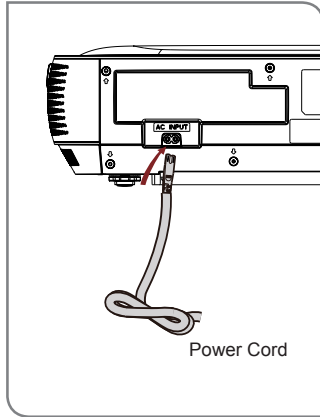

! WARNING: Insufficient ventilation space will cause this device to overheat or become damaged.

- Do not block the air vents or place any object on this device.
- Do not place this device in any narrow, enclosed or poorly ventilated space.

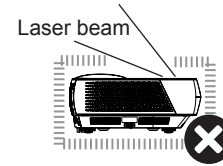

At a minimum, leave the amount of space shown in the diagram below for this device to have proper ventilation.

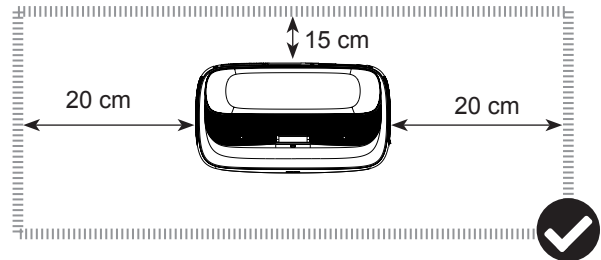

STEP 3 Adjust the Display Image and the Screen

Follow the steps in the order shown below, only if they apply to your situation.

NOTE: Before adjusting, fold the wall-mount bracket wands so that screen is vertically level. Rotate feet from an overlooking view, but do not look directly at the lens when the Laser TV is on because the laser light may damage your eyes.

PARALLEL THE BOTTOM OF THE IMAGE WITH THE SCREEN

If the bottom of the image is lower on the left and higher on the right, rotate the device counterclockwise.

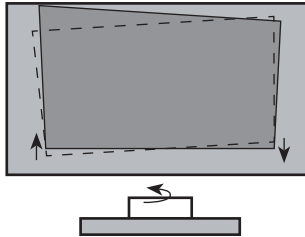

If the bottom of the image is lower on the right and higher on the left, rotate the device clockwise.

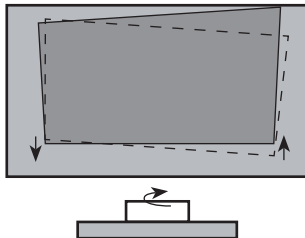

FIT THE BOTTOM OF THE IMAGE TO THE SCREEN

- If the image shifts to the left side, then move the Laser TV to the right.

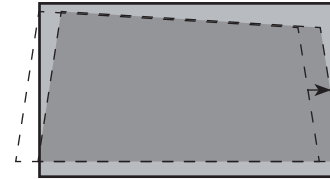

If the image shifts to the right side, then move the Laser TV to the left.

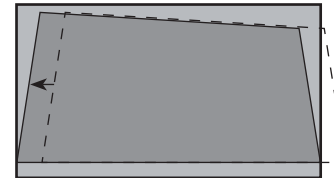

- If the bottom of the image is wider than the screen, then move the Laser TV closer to the screen.

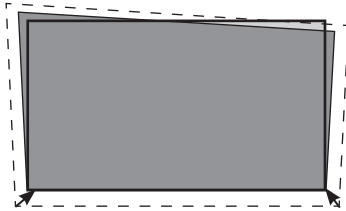

If the bottom of the image is narrower than the screen, then move the Laser TV farther from the screen.

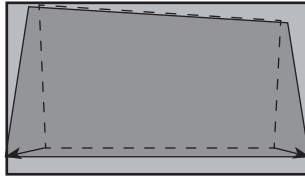

NOTE: Make sure the bottom of the image always stays parallel with the screen. If not, rotate the TV following previous instructions.

ADJUST THE UPPER-RIGHT CORNER OF THE IMAGE

1. If the top of the image is lower on the left and higher on the right, then use the wrench to rotate the front-right foot and the back-right foot clockwise to the same height.

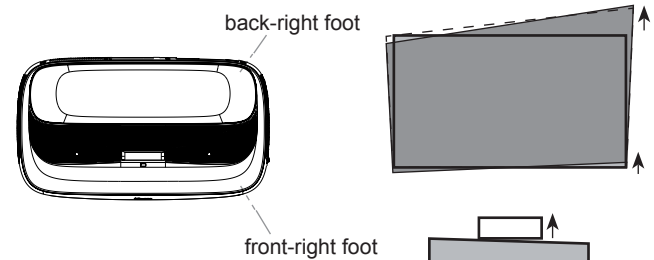

2. Now, rotate the TV counterclockwise so that the bottom of the image is parallel with the screen.

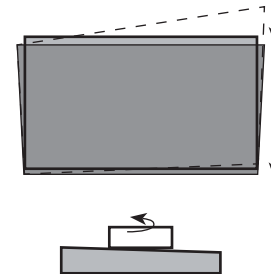

3. Repeat the steps above until the top of the image is parallel with the screen.

4. If the upper-right corner is inside the screen after adjusting, use the wrench to rotate the front-right foot and the back-right foot counterclockwise to the same height, and rotate the TV clockwise, to make the image parallel with the screen.

ADJUST THE UPPER-LEFT CORNER OF THE IMAGE

1. If the top of the image is higher on the left and lower on the right, then use the wrench to rotate the front-left foot and the back-left foot of the TV clockwise to the same height.

back-left foot

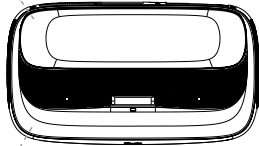

front-left foot

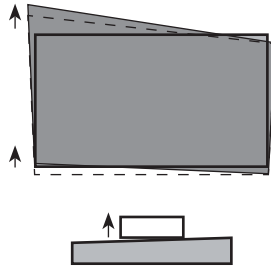

2. Now, rotate the TV clockwise so that the bottom of the image is parallel with the screen.

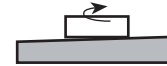
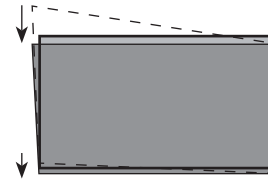

3. Repeat the steps above until the top of the image parallel with the screen.
4. If the upper-left corner is inside the screen after adjusting, use the wrench to rotate the front-left foot and the back-left foot counterclockwise to the same height, and rotate the TV counterclockwise, to make the image is parallel with the screen.

FILL THE TOP OF THE IMAGE TO THE SCREEN

If the top of the image is wider than the screen, then use the wrench to rotate the left- and right-front feet of the Laser TV clockwise.



If the top of the image is narrower than the screen, then use the wrench to rotate the left- and right-back feet of the Laser TV clockwise, until the left and right borders of the image are parallel with the screen borders.

Next, move the projector further from the screen to fill the image to screen width.

If the back feet are already at their maximum height, rotate the left- and right-front feet counterclockwise.

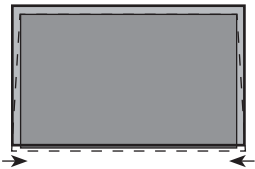

Rotate the back feet clockwise



Rotate the front feet
counterclockwise

STEP 4 Use Your Remote

BUTTONS ON YOUR TV REMOTE

NOTE: The button labels are provided as a reference. The actual appearance of the remote that is included with the TV, may differ from this diagram.

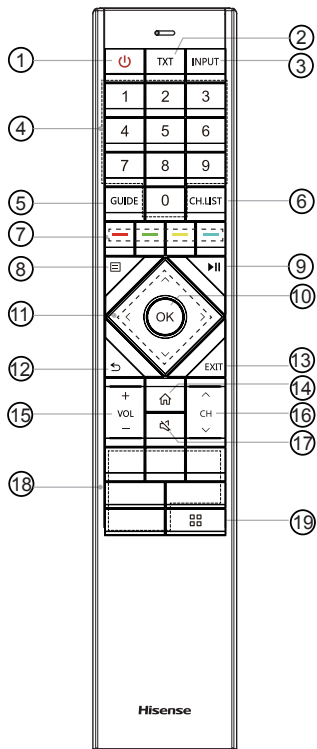

- ① Power Standby button: Power on / Standby
- ② Turn on/off the teletext function
- ③ Select input sources
- ④ Select a channel or input numbers
- ⑤ Display the Electronic Program Guide (DTV mode)
- ⑥ Display the Channel List on the screen
- ⑦ Special function buttons
- ⑧ Display the Menu
- ⑨ Refer to the diagram on screen to use $\wedge / \vee / \lt / \gt$ and OK to control content playback
- ⑩ OK - Confirm the selection
- ⑪ $\wedge / \vee / \lt / \gt$ - Allow you to navigate the OSD menus and adjust the system settings to your preference
- ⑫ Return to the previous place in the menu or app
- ⑬ Exit the menu
- ⑭ Display the Home screen
- ⑮ Change volume
- ⑯ Change channel (Up/Down)
- ⑰ Mute or restore the TV sound
- ⑱ APP: Quick access to the app
Note: The information here will vary depending on the country/region.
- ⑲ $\square\square$: All apps

NOTE: The included remote control will vary depending on models, countries / regions. Check information according to the actual remote control in the accessory bag.

BUTTONS ON YOUR TV REMOTE

NOTE: The button labels are provided as a reference. The actual appearance of the remote that is included with the TV, may differ from this diagram.

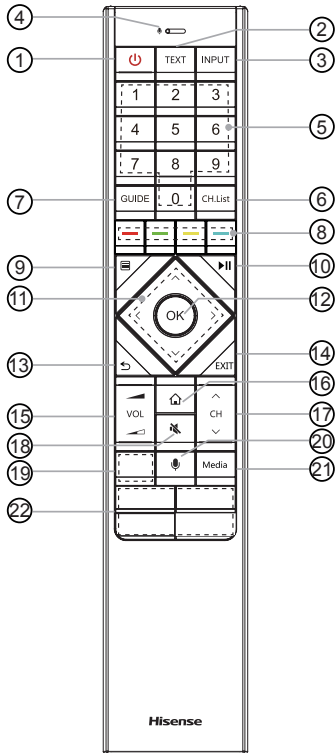

- ① Power button
- ② Turn on/off the teletext function
- ③ Select input sources
- ④ Receive the voice (This function is only supported in some countries or regions.)
- ⑤ Number buttons - Direct channel selection or numbers input
- ⑥ Display the Channel List on the screen
- ⑦ Display the Electronic Program Guide (DTV mode)
- ⑧ Special function buttons
- ⑨ Display the Menu
- ⑩ Refer to the diagram on screen to use $\wedge / \vee / < / >$ and OK to control content playback
- ⑪ $\wedge / \vee / < / >$ - Allow you to navigate the OSD menus and adjust the system settings to your preference
- ⑫ OK - Confirm the selection
- ⑬ Return to the previous place in the menu or app
- ⑭ Exit the menu
- ⑮ Change volume
- ⑯ Display the Home screen
- ⑰ Change channel (Up/Down)
- ⑱ Mute or restore the TV sound
- ⑲ \blacksquare : All apps
APP: Quick access to the app
Note: The information here will vary depending on the country/region.
- ⑳ Press to activate MIC (This function is only supported in some countries or regions.)
- ㉑ Media mode
- ㉒ APP: Quick access to the app
Note: The information here will vary depending on the country/region.

NOTE: The included remote control will vary depending on models, countries / regions. Check information according to the actual remote control in the accessory bag.

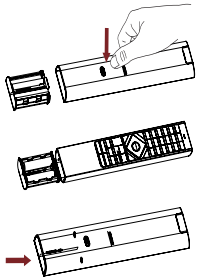

1. Press the switch and the battery case will pop up automatically.
2. Insert two AAA size batteries. Make sure to match the (+) and (-) ends of the batteries with the (+) and (-) ends indicated in the battery compartment.
3. Push the battery case back to the remote control.

NOTE: for some models, slide the back cover to open.

IMPORTANT INFORMATION ABOUT THE REMOTE AND BATTERIES

- Discard batteries in a designated disposal area. Do not throw them into a fire.
- Remove old batteries immediately to prevent them from leaking into the battery compartment.
- If you do not intend to use the remote control for a long time, then remove the batteries.
- Battery chemicals can cause a rash. If the batteries leak, clean the battery compartment with a cloth. If chemicals touch your skin then wash it immediately.
- Do not mix old and new batteries.
- Do not mix alkaline, standard (carbon-zinc) or rechargeable (NiCd, NiMH, etc.) batteries.
- Do not continue using the remote if it gets warm or hot.
- Call our Support Center immediately on the support website.

REMOTE CONTROL RANGE INFORMATION

- The remote control can work at a distance of up to 8 metres in front of the TV set. (This distance is used by infrared means in an unpaired state.)
- The remote control angle: taking the remote sensor as an apex, 6 metres away, its controlled horizontal angle is within $\pm 30^\circ$, while the vertical angle is within $\pm 15^\circ$. (This angle is used by infrared means in an unpaired state.)

PAIRING THE REMOTE CONTROL (ONLY FOR BLUETOOTH REMOTE CONTROL)

1. Pair the remote to the TV after you power it on. Keep the remote control within 3 metres from the TV. Press and hold the [] button at least 3 seconds to start pairing.
2. If the remote paired successfully then a confirmation will display on the screen. If it did not pair successfully then an 'unsuccessful' message will display. Repeat step 1.

NOTE:

- If an unknown error occurred with the remote then it could have been caused by interference. Try to remove what's causing the interference and pair it again.
- If an unknown error occurred in the remote control while the battery power is normal, you can take out the batteries and press any key for 1~2 seconds, then the remote control can work normally.
- The remote cannot be paired to the TV while the TV is in standby mode.

STEP 5 Proceed through the Screen Setup Menu

PROJECTION MODE

If you need to flip the image over top-to-bottom and/or left-to-right, select the Projection Mode.

AUTO GEOMETRIC CORRECTION

Before you use Auto Geometric Correction function, ensure that the Laser TV and your mobile device are connected to the same Wi-Fi network.

1. Position the Laser TV and use the leveling feet as needed to fit the entire display border within the screen area.



2. Click Next to continue.
3. Scan the QR Code with your mobile device to begin automatic geometric correction. When the app loads, the Laser TV will display an alignment grid.

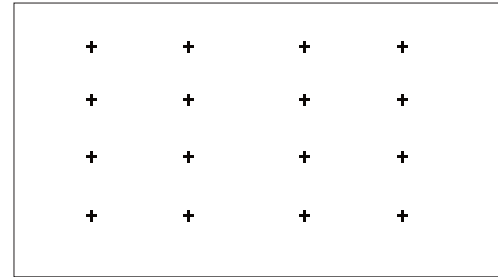

Alignment grid

4. Click "+" on your mobile device to take a photo of the entire screen and image. For best results, stand about 10 feet away from the screen and use landscape mode.
5. Click "upload" on your mobile device to complete the automatic geometric correction.

MANUAL GEOMETRIC CORRECTION

Select points and move to fit the projected image into the screen.

NOTE:

Manual Geometric Correction is only applicable in some models/countries/regions.

1. Press $\wedge / \vee / < / >$ buttons on your remote to move focus, and press OK button to choose a point you need to adjust.
2. Long press $\wedge / \vee / < / >$ buttons: quick adjustment of the projected image;
Short press $\wedge / \vee / < / >$ buttons: precise adjustment of the projected image.

3. Press ↵ button to save your adjustment, and you can select other points to adjust the image.

If you want to return the image position to the factory default, select Reset button on the screen.

EYE PROTECTION

In order to protect your eyes, keep the Eye Protection setting on, and do not look into the lens. If you get too close to the projector, the light output will be temporarily disabled after 5 second countdown.

STEP 6 TV Setup

Once you are satisfied with the projected image, select "TV Setup" to configure additional settings, including Network Connection.

Language	Select your desired language to be displayed on the menu.
TV Mode	Select "Home Mode" or "Store Mode".
Projection Mode	Select "Projection Mode".
Wireless Network	If your TV does not automatically detect an Ethernet connection, then use a wireless network, select your network from the list that displays, also you can add a hidden network. When you're done, move to the next screen.

Country	Select the Country where you will operate the TV.
Time Zone	Select the local time zone according to your region.
Auto Geometric Correction	Select Confirm to clear current settings and run the automatic geometric correction app.
End User License Agreement	Your use of this device is subject to the End User License Agreement, lack of your acceptance of the End User License Agreement will turn off all smart features of this device. You can choose to turn on/off each type of smart features separately, a click to the box of each type of smart feature means you give your consent to the corresponding privacy notice/terms and conditions.
Enhanced Viewing	Enhanced viewing can automatically adjust the picture mode and sound mode so as to match with the current content displayed on this device in case it is recognized by the automatic content recognition service. (This function is only applicable in certain models/countries.)
VIDAA Account Setup Screen	Link your TV with VIDAA account.

Maintenance

- Do not touch this device when it is running or just turned off because it may be hot.
- Do not wipe this device with oil because it may deteriorate the exterior or damage the paint. Contact with rubber or ethylene products for a long time may cause stains on this device.
- If the outside of the TV is dirty, turn off the TV and wipe with a damp soft cloth.
- Do not touch the lens with your hands.
- Do not touch or wipe the lens with ordinary cleaning cloth. Use a dust blower to remove the dust on the lens. Grease, dirt and fingerprints should be cleaned carefully by the professional by using optical cleaning cloth, lens wiping paper or professional cleaning solutions to avoid destroying the optical filming and affecting the image quality.
- To turn off this device, press the Power button on the remote control. Do not cut off the power directly when the device is working.

Quick Problem-Solving Tips

When you experience an issue with your TV, turn it off and on again. If this does not resolve the problem, then refer to the tips below.

When I turn on my TV, there is a delay for a few seconds before the picture appears. Is this normal?

Yes, this is normal. The TV is initializing and searching for previous setting information.

The light output of the projector is disabled.

In this case, if the power indicator illuminates red light for 5 times, please check whether the foreign object detection window is covered or dirtied. If so, uncover or carefully clean the foreign object detection window.

No sound or picture

1. Check if the power cord is plugged into a powered AC outlet.
2. Press the  Power button on the remote control to activate the unit from 'Standby' mode.
3. Check to see if the LED light is on or not. If it is, then the TV is receiving power.

I have connected an external source to my TV and I get no picture and/or sound.

1. Check for the correct output connection on the external source and for the correct input connection on the TV.
2. Make sure you have made the correct selection for the input mode for the incoming signal.

The picture is normal but there is no sound

1. Check the volume settings.
2. Check if 'Mute' mode is set to On.

Sound but no picture or black and white picture

1. If the picture is black and white, unplug the TV from the AC outlet and replug it after 60 seconds.
2. Check that the Colour is set to 50 or higher.
3. Try different TV channels.

The sound and/or picture is distorted or appears wavy

1. An electric appliance may be affecting the TV. Turn off any appliances that are nearby and move it farther away from the TV.
2. Insert the power plug of the TV set into another power outlet.

The sound and picture is blurry or cuts out

1. If using an external antenna, check the direction, position and connection of the antenna.
2. Adjust the direction of your antenna or reset or fine tune the channel.

The plastic cabinet makes a "clicking" type of sound

The 'click' sound can occur when the temperature of the television changes. This change causes the television cabinet to expand or contract, which makes the sound. This is normal and the TV is OK.

The remote control does not work

1. Confirm that TV still has power and is operational.
2. Change the batteries in the remote control.
3. Check if the batteries are correctly installed.

Product Specifications

Model Name		100" Laser TV
Dimension (W × H × D)		24.0 × 6.1 × 13.6 inches (610 × 155 × 346 mm)
Weight		24.7 lbs (11.2 kg)
Active Screen Size (Diagonal)		100 inches
Screen resolution		3840 × 2160
Audio power		2 × 20 W
Power consumption		320 W
Power supply		120-240V ~ 50/60Hz
Receiving systems	Analog	PAL-D/K, B/G, I, SECAM-D/K, B/G
	Digital	DVB-T/T2, DVB-C, DVB-S/S2
Wireless LAN Module specifications	Model	WF-M668-UWP1
	Frequency Range	2.4~2.4835GHz 5.15~5.85GHz
	Output Power (Max.)	2.4~2.4835GHz 16dBm 5.15~5.25GHz 14dBm 5.25~5.35GHz(DFS Band) 14dBm 5.49~5.71GHz(DFS/TPC Band) 14dBm 5.725~5.85GHz(for Non EU) 14dBm

Bluetooth Module specifications	Model	WF-M668-UWP1
	Frequency Range	2.4~2.4835GHz
	Output Power (Max.)	2.4~2.4835GHz, Class1, 6dBm
Remote Control specifications	Model	ERF6A64 / ERF6B64H
	Frequency Range	2.4~2.4835GHz
	Output Power (Max.)	2.4~2.4835GHz 5dBm
Environmental conditions		Temperature: 41°F - 104°F (5°C - 40°C) Humidity: 20% - 80% RH Atmospheric pressure: 86 kPa - 106 kPa
HDMI Input		RGB / 60 Hz (640×480, 800×600, 1024×768) YUV / 60 Hz (480i, 480p, 720p, 1080i, 1080p) YUV / 50Hz (576i, 720p, 1080i, 1080p) 3840×2160 / 24Hz, 3840×2160 / 25Hz, 3840×2160 / 30Hz 3840×2160 / 50Hz, 3840×2160 / 60Hz
Network Standby Power Consumption		≤ 2.0 W
Power Consumption in Standby Mode		≤ 0.5 W
WIFI		IEEE802.11 a/b/g/n/ac
Bluetooth		BT5.0

Disclaimer: All products, product specifications, and data are subject to change without notice to improve reliability, function, design or otherwise.

Recycling / Licenses

WEEE (Waste Electronic Electric Equipment)

European Directive 2012/19/EU



This symbol on the product or on its packaging indicates that this product must not be disposed of with your household waste. Instead, it is your responsibility to dispose of your waste equipment by handing it over to a designated collection point for the recycling of waste electrical and electronic equipment. The separate collection and recycling of your waste equipment at the time of disposal will help to conserve natural resources and ensure that it is recycled in a manner that protects human health and the environment. For more information about where you can drop off your waste equipment for recycling, please contact your local city office, your household waste disposal service or the shop where you purchased the product.

Batteries



In accordance with the Battery Directive, used batteries should not be disposed of in the domestic waste. Dispose your batteries in the collection containers specific for this purpose in retail stores.

ROHS (Restriction of Hazardous Substance)

European Directive 2011/65/EU



This European directive limits the use of dangerous and hazardous substances which are difficult to recycle. This allows recycling easily the EEE and contributes to the safeguard of the environment. Substances included in this product match to the RoHS directive.



The terms HDMI and HDMI High-Definition Multimedia Interface, and the HDMI Logo are trademarks or registered trademarks of HDMI Licensing Administrator, Inc. in the United States and other countries.



Manufactured under license from Dolby Laboratories. Dolby, Dolby Atmos, and the double-D symbol are trademarks of Dolby Laboratories. Confidential unpublished works. Copyright © 2012-2019 Dolby Laboratories. All rights reserved.

SIMPLIFIED EU DECLARATION OF CONFORMITY

Hereby, Hisense Visual Technology Co., Ltd. declares that the radio equipment type [100L9GE / 100L9 / 100L9G / 100L9GA / 100L9GB / 100L9GC / 100L9GCH / 100L9GTUK / 100L9GTUKA / 100L9GTUKB / 100L9GTUKC / 100L9G-A12 / 100L9G-B12 / 100L9G-C12 / 100L9G-D12 / 100L9GCH-A12 / 100L9GCH-B12 / 100L9GTUK-A12 / 100L9GTUK-B12 / 100L9GTUK-C12 / 100L9GTUK-D12 / ERF6A64 / ERF6B64H] is in compliance with Directive 2014/53/EU. The full text of the EU declaration of conformity is available at the following internet address: <http://global.hisense.com/downloads>.

For Great Britain:

SIMPLIFIED UK DECLARATION OF CONFORMITY

Hereby, Hisense Visual Technology Co., Ltd. declares that the radio equipment type [100L9GE / 100L9 / 100L9G / 100L9GA / 100L9GB / 100L9GC / 100L9GCH / 100L9GTUK / 100L9GTUKA / 100L9GTUKB / 100L9GTUKC / 100L9G-A12 / 100L9G-B12 / 100L9G-C12 / 100L9G-D12 / 100L9GCH-A12 / 100L9GCH-B12 / 100L9GTUK-A12 / 100L9GTUK-B12 / 100L9GTUK-C12 / 100L9GTUK-D12 / ERF6A64 / ERF6B64H] is in compliance with Radio Equipment Regulations 2017. The full text of the UK declaration of conformity is available at the following internet address: <http://global.hisense.com/downloads>.

ES-A2132Z2-1

