

Hisense

USER MANUAL

Before using the TV, please read this manual thoroughly and retain it for future reference.

ENGLISH

FRANÇAIS

ESPAÑOL

Hisense

USER MANUAL

Before using the TV, please read this manual thoroughly and retain it for future reference.

Copyright Statement

© 2019 Hisense Company Ltd. All Rights Reserved.

All material in this User Manual is the property of Hisense Company Ltd. and its subsidiaries, and is protected under US, CANADA, MEXICO and International copyright and/or other intellectual property laws. Reproduction or transmission of the materials, in whole or in part, in any manner, electronic, print, or otherwise, without the prior written consent of Hisense Company Ltd. is a violation of Hisense Company Ltd. rights under the aforementioned laws.

No part of this publication may be stored, reproduced, transmitted or distributed, in whole or in part, in any manner, electronic or otherwise, whether or not for a charge or other or no consideration, without the prior written permission of Hisense Company Ltd.

Requests for permission to store, reproduce, transmit or distribute materials may be made to one of the following addresses:

USA: Hisense USA Corporation
7310 McGinnis Ferry Road
Suwanee, GA 30024

CANADA: Hisense Canada Co., Ltd
2283 Argentia Road, Unit 16
Mississauga, ON, Canada
L5N 5Z2

MEXICO: Hisense Mexico S. de R.L. de C.V.
Blvd. Miguel de Cervantes Saavedra No 301
Torre Norte Piso 2, Col. Ampliación Granada
Miguel Hidalgo, Ciudad de México, C.P. 11520

Hisense, and any and all other Hisense product names, logo's, slogans or marks are registered trademarks of Hisense Company Ltd. and its subsidiaries. All other trademarks are the property of their respective holders.

©2019. All rights reserved. Hisense and the Hisense logo are registered trademarks of Hisense. Other brand and product names are registered trademarks of their respective owners.

Disclaimer Page

**Notwithstanding anything to the contrary, including in any or all descriptions, representations, statements or other communications related to this Hisense device (hereinafter "Device") made in any form whatsoever and at any time, some or all of the pre-installed, or subsequently installed Application Services may not be available or capable of functioning as intended by the provider of the Application Services in any or all usage areas for reasons outside of Hisense's control, including but not limited to, Internet access, local service limitations, etc. Any purchase or use of the Device, including any Application Services, is purely at the user's risk. Application Services are provided on an as-available basis without warranties of any kind, either expressed or implied, that the Application Service will be uninterrupted or error-free, including but not limited to vagaries of weather, disruption of Service, acts of God, warranties of title, local or regional limitations, no infringement, NOR IMPLIED WARRANTIES OF MERCHANTABILITY OR FITNESS FOR A PARTICULAR PURPOSE. No advice or information given by Hisense, providers, affiliates, or contractors or their respective employees shall create such a warranty. Hisense specifically disclaims responsibility for any or all Application Services from functioning at any time, and by purchasing the Device, you accept such disclaimer without any claim on Hisense. You are solely responsible for providing an active and working connection to the Internet, along with any and all hardware and/or software necessary to use the Hisense Device as intended.

Disclaimer:

Images throughout this document are for illustrative purposes only and may differ from the actual product.

Content

Content	3
Connecting Devices to your TV	5
Connecting an antenna, cable set-top box or satellite receiver	5
Connecting a satellite receiver, DVD player or other audio visual (AV) devices with a composite video cable (yellow/white/red).....	5
Connecting an AV device with an HDMI cable.....	6
Connecting a headphone	6
Connecting a USB device.....	6
Connecting speakers or other audio receivers.....	7
Connecting a digital sound bar to use Audio Return Channel (ARC).....	8
Connecting Your TV to a Wireless or Wired Network	9
Connecting to a wireless network	9
Connecting to a wired (Ethernet) network.....	9
Using Your TV Remote Control	11
Buttons on your TV remote.....	11
Remote control range information.....	13
Begin using your remote	13
Pairing the Remote Control (only for US 32")	13
Other	13
Completing the Setup Wizard Menu	15
Shortcuts Instructions	16
Turning your TV on or off.....	16
Using the Live TV	16
Using shortcuts	16
Using the Menu Function	17
Home	18
Getting familiar with the Home screen	18
Settings	19
Using the Menu	19
Network & Internet	19
Channel.....	19
Accounts & Sign In	20
Apps.....	20
Device Preferences.....	20
Remotes & Accessories	20

Device Preferences	21
About.....	21
Date & time	21
Timer	21
Language.....	21
Keyboard	21
Inputs	21
Power	22
Picture.....	22
Sound.....	22
Storage.....	23
Home screen.....	23
Store Mode.....	23
Google	23
Chromecast built-in.....	23
Screen saver	23
Location	23
Usage & Diagnostics	23
Security & restrictions	23
Accessibility	23
Reset.....	24
Parental Controls.....	25
Apps	27
Installing an App	27
Removing an App	27
Moving App Icons around.....	27
MultiMediaPlayer	28
File formats that may be supported	28
Browsing Content.....	28
Quick Problem-Solving Tips	29

Connecting Devices to your TV

You have several options for connecting your TV to different devices. The method you choose will be based upon the type of cables you have and the available outputs on your device.

Connecting an antenna, cable set-top box or satellite receiver

To connect an antenna, cable set-top box or satellite receiver:

1. Connect one end of a coaxial cable (not included) to the **RF OUT** port on the antenna, cable or satellite box. If you are using an antenna with twin-lead cable, you may need a 300-75 Ohm adapter (not provided) to connect it to the back of your TV. Likewise, if you are using several antennas, you may need a combiner (not provided).
2. Connect the other end of the cable to the **ANT/CABLE** port on the side of TV.
3. Using your remote, select the  **Inputs** icon in Home screen and select **Channels** as the input source.

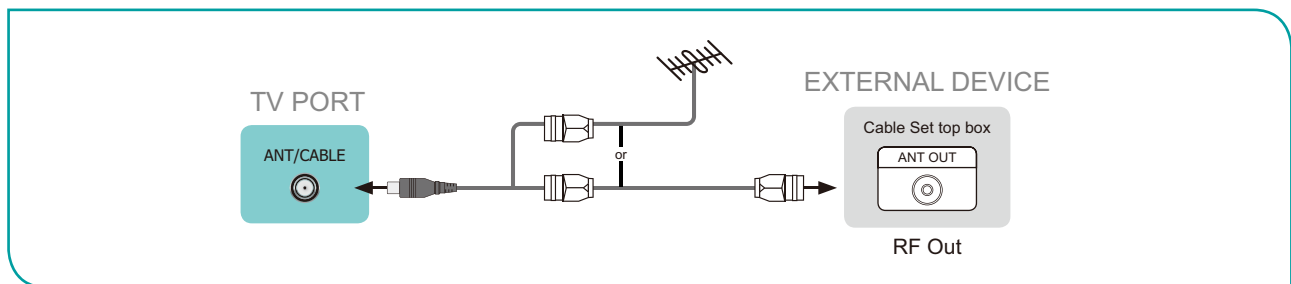

Connecting a satellite receiver, DVD player or other audio visual (AV) devices with a composite video cable (yellow/white/red)

To connect an AV device with a composite video cable (not provided):

1. Use the audio and video cables to connect the composite video/audio ports of the external AV device to the **AV IN** ports of the TV. (Video = yellow, Audio Left = white, and Audio Right = red)
2. Plug the connected devices into the AV connectors on the TV before switching it on.
3. Using your remote, select the  **Inputs** icon in Home screen and select **Composite** as the input source.

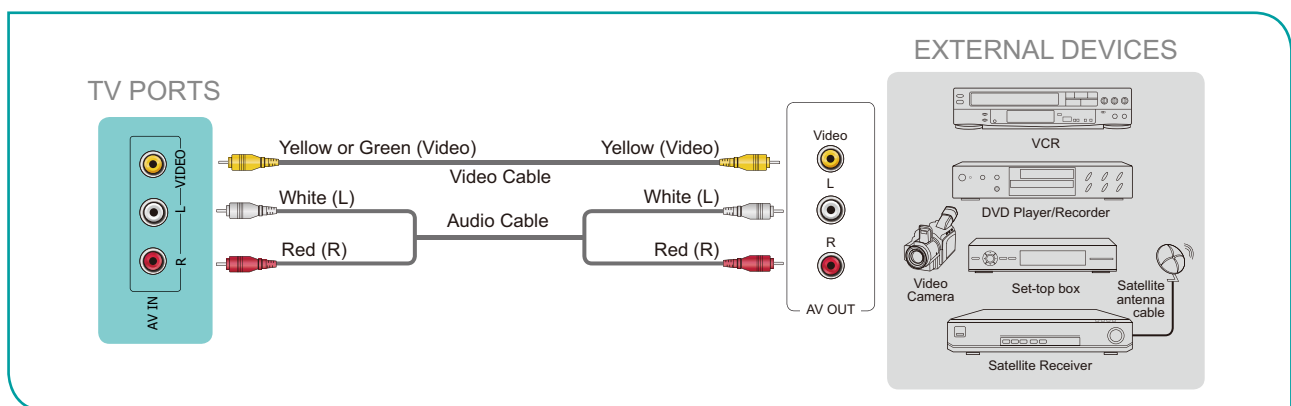

Connecting an AV device with an HDMI cable

This type of connection supports digital connections between HDMI-enabled AV devices such as a Personal Video Recorder(PVR), DVD, AV receiver and digital devices. The HDMI version 1.4 inputs are great for any of your external devices that support a standard full high-definition resolution of 1080p.

Please refer to the User Manual that came with your device for step-by-step instructions.

To connect an AV device with an HDMI cable (not provided):

1. Use an HDMI cable to connect the HDMI output port of the AV device to the **HDMI** port of the TV.
2. Plug the connected devices into the **HDMI** port on the TV before switching it on.
3. Using your remote, select the  **Inputs** icon in Home screen and select the corresponding **HDMI** input.

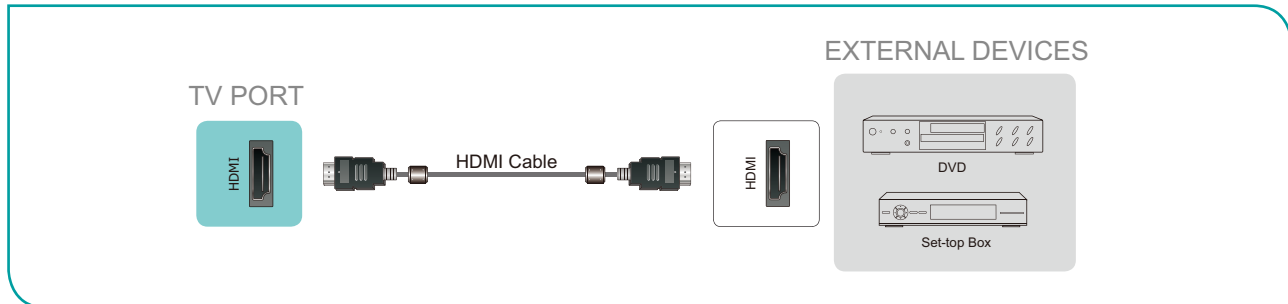

NOTES

- Because the HDMI connector provides video and audio signals, it is not necessary to connect an audio cable.
- We strongly recommend to use HDMI Cable with 2 cores as shown in the figure.

Connecting a headphone

You can connect headphone (not provided) to the **HEADPHONE** port on your TV. While the headphone is connected, the sound from the built-in speakers will be disabled.

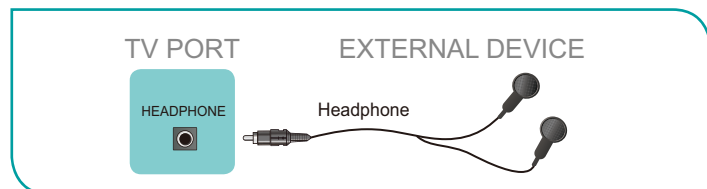

NOTES

- Headphones with microphones are not supported.

Connecting a USB device

You can connect the USB devices such as hard drives, USB sticks and digital cameras for browsing photos, listening to music and watching recorded videos.

1. Connect a USB device into the **USB** port.
2. Select the content you want to play or view. For more information, see [MultiMediaPlayer on page 28](#).

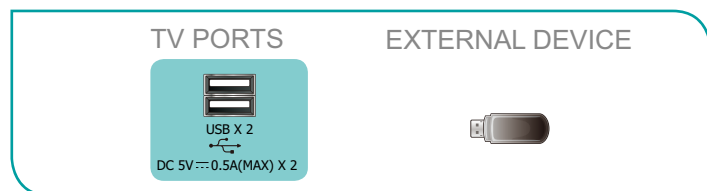

NOTES

- When connecting a hard disk or a USB hub, always connect the mains adapter of the connected device to the power supply. Exceeding a total current consumption may result in damage. The USB1.1 and USB2.0 devices maximum current consumption are 500mA.
- For individual non-standard high-capacity mobile hard disk, if its impulse current is greater than 500mA, it may cause TV-rebooting or self-locking. So the TV does not support it.
- The USB port supports a voltage of 5V.

Connecting speakers or other audio receivers

To connect speakers or other audio receivers with an audio cable (not provided):

1. Use an audio cable to connect the digital audio in port of the audio receiver device to the **DIGITAL AUDIO OUT** port of the TV.
2. Plug the connected devices into the main power socket before switching on the TV.

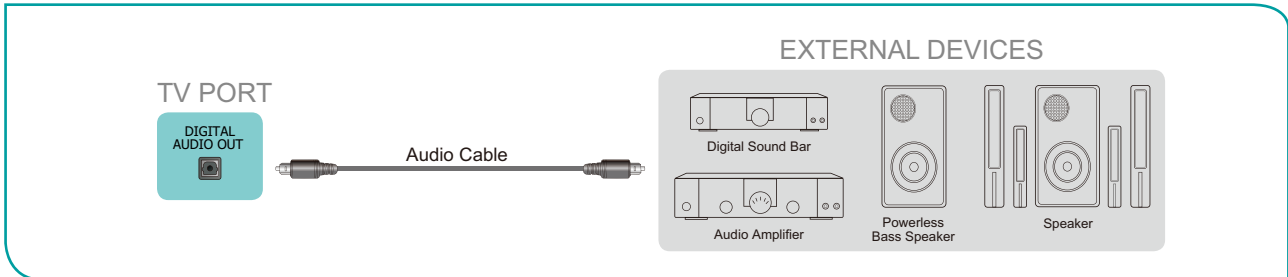

TIP: If you prefer to use Audio Return Channel, then see [Connecting a digital sound bar to use Audio Return Channel \(ARC\) on page 8](#).

NOTES

- When a digital audio system is connected to the **DIGITAL AUDIO OUT** port, decrease the TV and system volume.
- You can connect the **DIGITAL AUDIO OUT** port on the back of the TV to the Optical port on the Amplifier.

Connecting a digital sound bar to use Audio Return Channel (ARC)

If you'd like to use the Audio Return Channel (ARC) feature to have sound sent from the TV back down an HDMI cable to a digital sound bar, then you will need to connect the cable to the **HDMI / ARC** port. By using this feature, you will also be able to control the sound bar with your TV remote instead of using multiple remotes for each device.

To connect a digital sound bar with an HDMI cable (not provided):

1. Connect the cable that's attached to the sound bar to the **HDMI / ARC** port on the TV.
2. Turn on the sound bar by pressing the Power button.

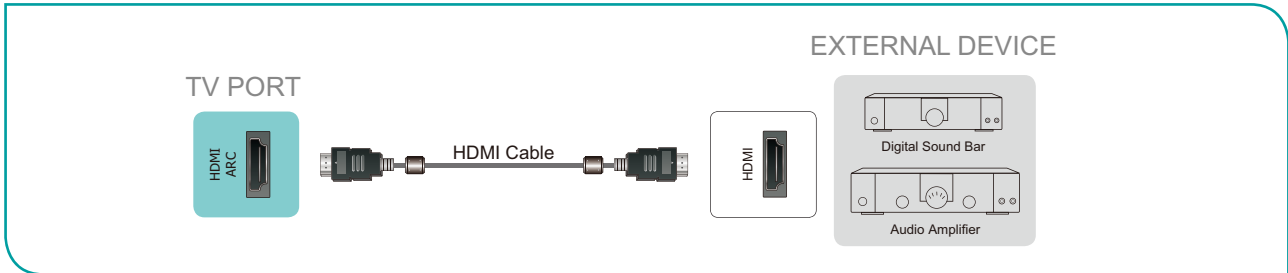

NOTES

- Only digital sound bars that require a wired connection are compatible with the TV.
- If the device has an Input Selector feature then make sure to change it to TV.

Connecting Your TV to a Wireless or Wired Network

You have the option to connect your TV to a wireless or wired network to access the Internet. For more information about the network settings on TV, see [Network & Internet on page 19](#).

Connecting to a wireless network

Our built-in wireless LAN adapter supports the IEEE 802.11 b/g/n communication protocols and we recommend that you use an IEEE 802.11n router. When you play a video over an IEEE 802.11 b/g connection, the video may not play smoothly.

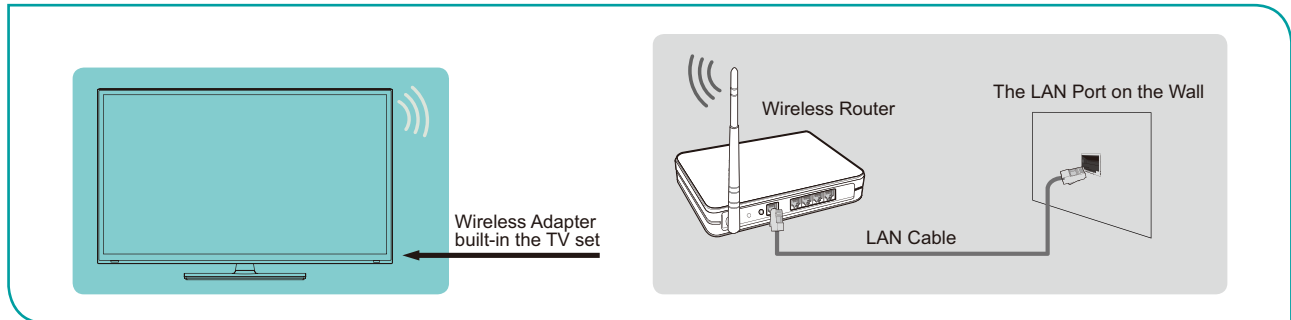

NOTES

- You must use the built-in Wireless LAN Adapter to use a wireless network because the set does not support an external USB network adapter.
- To use a wireless network, your TV must be connected to a wireless IP sharer. If the wireless IP sharer supports Dynamic Host Configuration Protocol (DHCP), your TV can use a DHCP or static IP address to connect to the wireless network.
- Select a channel for the wireless IP sharer that is not currently being used. If the channel set for the wireless IP sharer is currently being used by another device nearby, this will result in interference and communication failure.
- If you apply a security system other than the systems listed below, it will not work with the TV.
- If Pure High-throughput (Greenfield) 802.11N mode is selected and the Encryption type is set to WEP, TKIP or TKIP-AES (WPS2 Mixed) for your Access Point (AP), then the TV will not support a connection in compliance with these Wi-Fi certification specifications.
- If your access point (AP) supports Wi-Fi Protected Setup (WPS), you can connect to the network via Push Button Configuration (PBC) or PIN (Personal Identification Number). WPS will automatically configure the SSID and WPA key in either mode.

Connecting to a wired (Ethernet) network

You can attach your TV to your LAN in one of the three following ways:

Option 1

You can attach your TV to your LAN by connecting the **LAN** port on the back of your TV to an external modem using a Cat 5 LAN cable. See the illustration below.

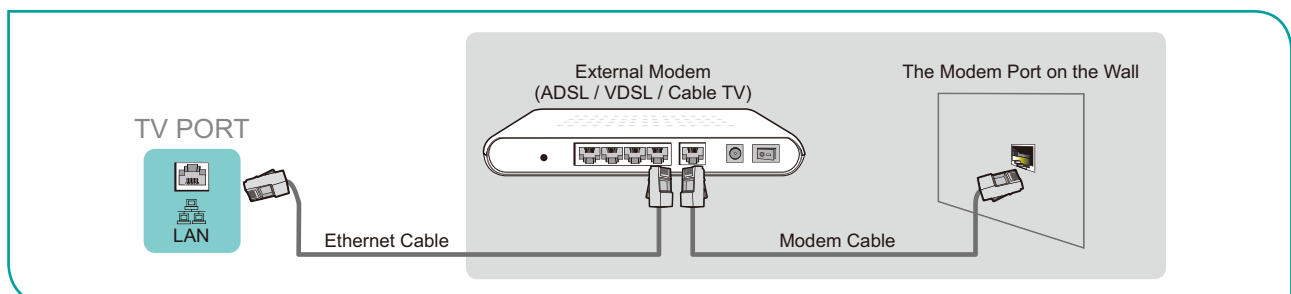

● Option 2

You can attach your TV to your LAN by connecting the **LAN** port on the back of your TV to an IP Sharer which is connected to an external modem. Use an Ethernet cable for the connection. See the illustration below.

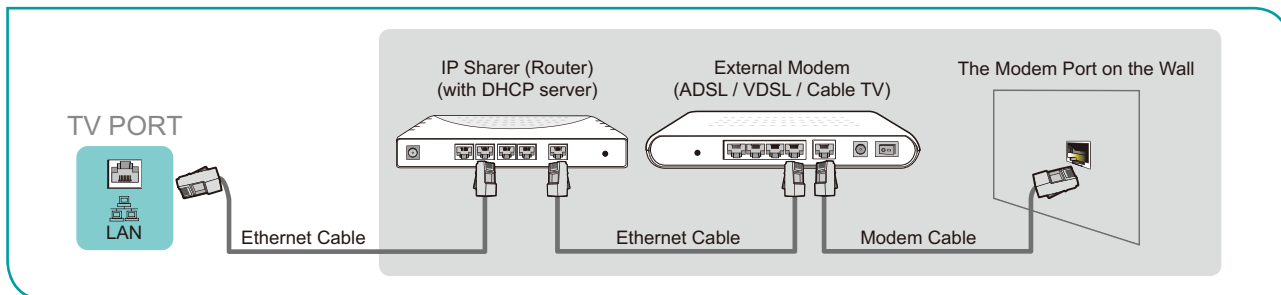

● Option 3

Depending on how your network is configured, you may be able to attach your TV to your LAN by connecting the **LAN** port on the back of your TV directly to a network wall outlet with an Ethernet cable. See the diagram below.

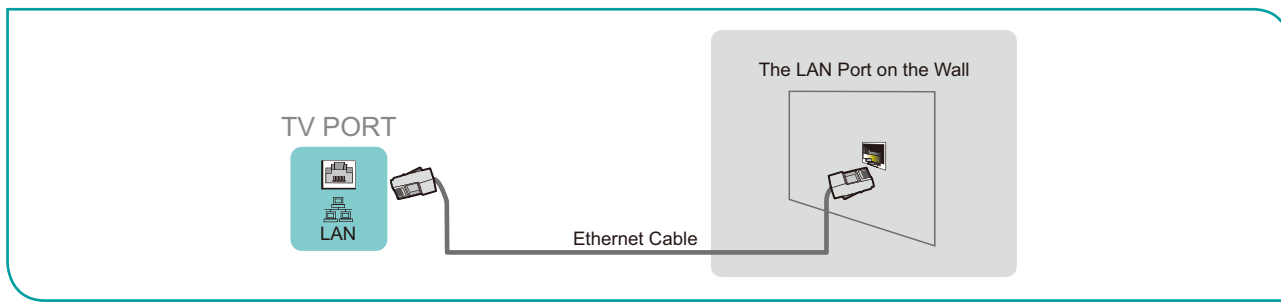

If you have a Dynamic Network, you should use an ADSL modem or router that supports Dynamic Host Configuration Protocol (DHCP). Modems and routers that support DHCP automatically provide the IP address, subnet mask, gateway, and DNS, so you don't have to enter them manually. Most home networks are Dynamic Networks.

Some networks require a Static IP address. If your network requires a Static IP address, you must enter the IP address, subnet mask, gateway, and DNS values manually on your TV's Cable Setup Screen when you set up the network connection. To get the IP address, subnet mask, gateway and DNS values, contact your Internet Service Provider (ISP).

☑ **NOTE**

- You can use ADSL modems that support DHCP if your network requires a static IP address. ADSL modems that support DHCP also let you use static IP addresses.

Using Your TV Remote Control

Buttons on your TV remote

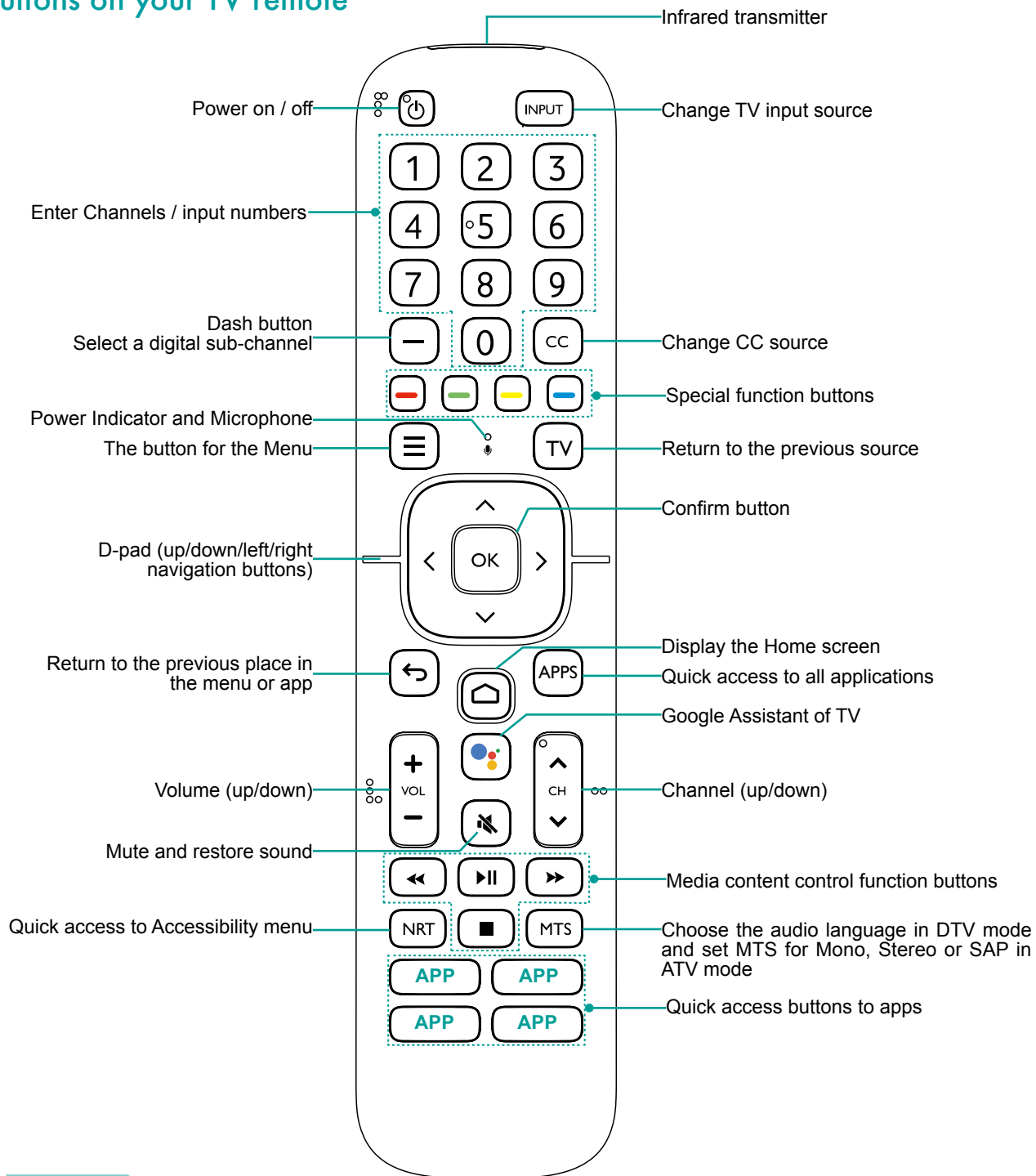

NOTE

- The buttons are only for reference, actual remote may vary in appearance.
- The remote supports both infrared and Bluetooth connection mode.

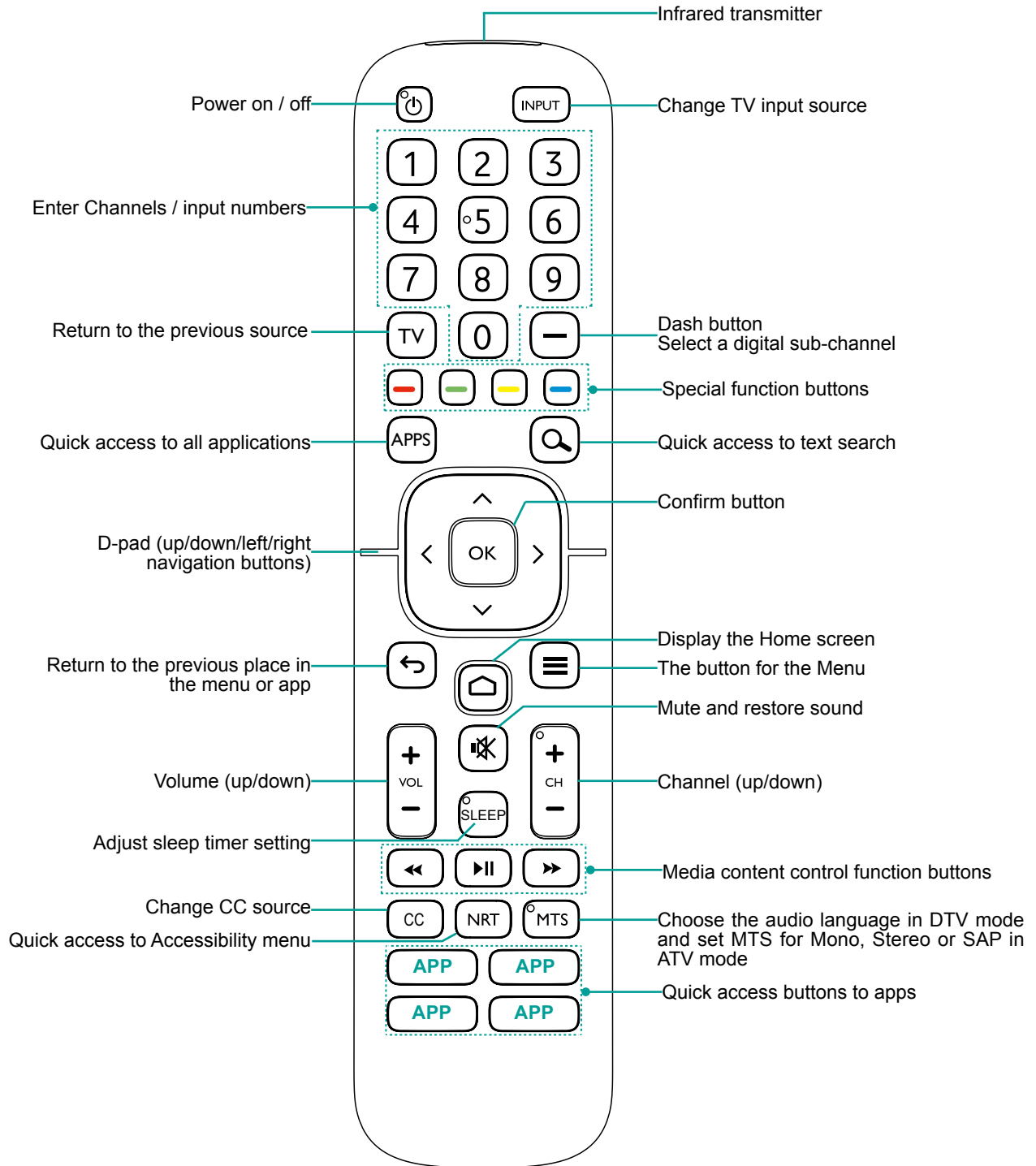

NOTE

- The buttons are only for reference, actual remote may vary in appearance.
- The remote supports infrared connection mode.

Remote control range information

- The remote control can work at a distance of up to 26 feet in front of the TV set.
- It can work at a 30 degree horizontal or vertical angle.



Begin using your remote

1. Slide the back cover to open the battery compartment of the remote control.
2. Insert two AAA size batteries. Make sure to match the (+) and (-) ends of the batteries with the (+) and (-) ends indicated in the battery compartment.
3. Replace the battery compartment cover.

NOTES

- Discard batteries in a designated disposal area. Do not throw them into a fire.
- Remove old batteries immediately to prevent them from leaking into the battery compartment.
- If you do not intend to use the remote control for a long time, remove the batteries.
- Battery chemicals can cause a rash. If the batteries leak, clean the battery compartment with a cloth. If chemicals touch your skin then wash it immediately.
- Do not mix old and new batteries.
- Do not mix alkaline, standard (carbon-zinc) or rechargeable (NiCd, NiMH, etc.) batteries.
- Do not continue using the remote if it gets warm or hot.
- Call our Support Center immediately on the support website.

Pairing the Remote Control (only for US 32")

1. Pair the remote to the TV after you power it on. Keep the remote control within 10 feet from the TV.
2. Press the **Home** button on the remote control, select  icon to enter the **Settings** menu to select **Remotes & Accessories**.
3. Press and hold the [] button at least 3 seconds, then the remote name will be showed on the menu.
4. Select the remote name, and press the [**OK**] button to start pairing.
5. If the remote paired successfully then a confirmation message will display on the screen. If it did not pair successfully then an 'unsuccessful' message will display. Repeat the previous steps.

NOTES

- If an unknown error occurred with the remote then it could have been caused by interference. Try to remove what's causing the interference and pair it again.
- If an unknown error occurred in the remote control while the battery power is normal, you can take out the batteries and press any key for 1~2 seconds, then the remote control can work normally.
- The remote cannot be paired to the TV while the TV is in standby mode.

Other

Program your universal cable or satellite remote control to operate your new television (only for USA)

If you would like to program your other household remote controls to your new television, please refer to the User's Manual supplied by your Cable or Satellite provider. The Cable or Satellite providers' User's Manuals should include instructions on how to program their remote to your television.

A list of codes for the most common Cable and Satellite providers are listed below. Use the code that is associated with your Cable or Satellite provider (if applicable).

DIRECTV

0178, 10178, 10019, 10748, 11314, 11660, 11710, 11780, 12049, 10171, 11204, 11326, 11517, 11564, 11641, 11963, 12002, 12183

Time Warner Cable

386, 0178, 10178, 400, 450, 461, 456, 0748, 1463, 0463, 10463

Comcast

0178, 10178, 10463, 11463, 10748, 11314, 11660, 10171, 11204, 11326, 11517, 11641, 11780, 11785, 11892, 11963, 12002

Cox Communications

0178, 10178, 1326, 1463

Dish Network

505, 627, 538, 720, 659

If the code associated with your Cable or Satellite provider is not listed, does not work or you cannot locate the instructions to program your remote, call your local Cable or Satellite provider's customer service center.

If your Cable or Satellite provider does not have a code available, please contact us.

Using your cable set-top box or satellite receiver remote as a 'universal' remote

If you prefer to use your Cable Set-top Box or Satellite Receiver Remote as a 'universal' remote, visit the Support page to view a list of the codes.

Completing the Setup Wizard Menu

Plug the power cord into an AC outlet, the TV will turn on for the first time.

After the splash screen that displays the logo appears, begin the Setup Wizard menu.

The guide setting is completed according to the boot navigation prompt. The navigation information is specific to the actual condition.

The Home screen will be your starting point for navigating the TV.

Shortcuts Instructions

You can use shortcuts on the remote control for fast operation.

Turning your TV on or off

- To turn your TV on:
 1. Plug the power cord into an AC outlet.
 2. When the TV is powered on, press the **[⏻]** button on the remote to turn on TV. (Except the first time)
- To turn your TV off, press the **[⏻]** button on the remote.

NOTES

- When your TV is in standby mode, it is still consuming power. To completely disconnect power, please remove the plug from the AC outlet.
- If your TV does not receive an input signal for several minutes, it automatically goes into standby mode.

Using the Live TV

To view broadcast programs, press the **[🏠]** button on your remote, select the **[📺] Inputs** icon in Home screen and select **Channels** as the input source.

Channel search guide

When you select **Channels** as input, you can search for channels. You can go to **Settings > Channel** to change the channel settings.

Viewing channel information

As you use the **[CH ^ / ∨]** button on your remote to scroll through channels, an information banner appears on the top of the screen.

Viewing a channel list

After you have done channel scan (if you're using an antenna) or receiving your channels through a cable provider, you can view your list of channels by pressing **[OK]** on your remote.

You will see the channel list display on the screen.

Creating a Favorite List

To quickly access your most-watched channels, you can create a Favorite List.

The way is to create your Favorite List in Menu:

1. Press the **[☰]** button to access the **Menu** in Channels source.
2. Press the **[Up]** button to Channels and press **[OK]** button to add to my favorite.

Viewing your Favorite list

To view channels that you've added to your Favorite List simply press **[OK]** on your remote to call out the channel list.

The channel list appears on the screen. You can press the "blue" special button to view your favorite list.

Using shortcuts

Google Assistant

You can press the **[🗨️]** button to turn on your Google Assistant, use your voice to ask it questions, tell it to do things.(only for US 40")

Closed Captions (CC)

Change CC source.

Narration (NRT)

Quick access to Accessibility menu.

Multi-audio (MTS)

You can choose the audio language in DTV mode and you can set MTS for Mono, Stereo or SAP in ATV mode.

Using the Menu Function

You can press the [≡] button to quickly access menu function in TV mode.

Picture Mode

If you'd like to configure the settings for your picture, then there are seven types of picture modes available: **User**, **Standard**, **Vivid**, **Sport**, **Movie**, **Game**, and **Energy Saving**.

Display Mode

Adjust the Aspect Ratio to stretch or zoom in on your picture. You can choose from the following settings: **Automatic**, **Super zoom**, **4:3**, **Movie expand 14:9**, **Movie expand 16:9**, **Wide screen**, **Full** or **Unscaled**.

Closed Captions

Adjust Closed Caption settings to your preference.

Multi-audio

You can choose the audio language in DTV mode and you can set MTS for Mono, Stereo or SAP in ATV mode.

ARC

You can turn ARC On or Off.

Power

Adjust the timer settings to suit your preference. You can **Sleep Timer**, **Picture off**, **Switch off timer**, **No Signal Auto Power Off**.

Advanced Options

You can turn Blue Mute On or Off. You can view the version information

Settings

The Settings Menu consists of the following settings: Network & Internet, Channel, Accounts & Sign In, Apps, Device Preferences, Remotes & Accessories.

Home

Getting familiar with the Home screen

The simple design of the **Home** screen menu makes it easy to navigate. And you can easily add or delete applications in the Home interface according to your needs.

To access the Home screen, press the [] button on your remote control and use the D-pad to make your selection.

Indicators and Icons on the top of the Home screen

- **Google Assistant:** You can search movies, TV, and more by speaking.
- **Google Search:** You can search movies, TV, and more by typing.
- **Notifications:** Notifications can come from the system, an external device, an application, the media player etc.
- **Inputs:** Select the Input source depending on the device you have connected to your TV.
- **Network & Internet:** You can set up the Network & Internet.
- **Settings:** Settings lets you configure the TV, set app options, add accounts, and change other preferences.
- **Time:** You can always view the current time at the top right corner of the Home screen.

Names of sections that appear on the Home screen

The Home screen displays the following section names:

- **Apps**
- **Trending**
- **Featured**

NOTE

- Names of sections will change according to Google's software.

Settings

Using the Menu

You can press the [⚙️] icon on home screen to access the **Settings Menu**. Also You can press the [☰] button to access the **Menu** to select the settings menu in TV mode.

The Menu consists of the following settings:

- **Network & Internet**
- **Channel**
- **Accounts & Sign In**
- **Apps**
- **Device Preferences**
- **Remotes & Accessories**

In each menu, you can:

- Press the [Up / Down] buttons to select an item.
- Press the [OK] buttons to enter the sub-menu.
- Press the [↶] button to return to the previous menu.

Network & Internet

- **Wi-Fi:** Turn on the Wi-Fi to access the Internet via a wireless network connection.
Select an available network, press [OK] to confirm. A screen will appear prompting you to enter the password if necessary.
 - **See all / See fewer:** Press [OK] to view all available network or fewer.
 - **Add new network:** You can add wireless network.
 - **Scanning always available:** Check to scan for networks even when Wi-Fi is turned off.
 - **Wow:** Wake on wireless network.
 - **Wol:** Wake on LAN.
 - **Connected / Not connected:** Show whether the Ethernet is connected
 - **Proxy settings:** You can set the proxy server.
-  **NOTE**
- HTTP proxy is used by the browser but may not used by other apps.
- **IP settings:** Configure the IP setting for your network connection.

Channel

- **Channel Sources:** Set up your sources. Get started by setting up the channel sources already installed. Or browse the online store for more apps that offer live channels.
- **Customize Channel List:** Choose channels for your program guide.
- **Channel Installation Mode:** Choose channel installation mode for Antenna or Cable.
- **Parental Controls:** The Parental Controls setting allows you to block content that is not appropriate for children to watch. See [Parental Controls on page 25](#).
- **Multi Audio:** You can choose the audio language in DTV mode.
- **Open Source Licenses:** Click to read the Licenses details.
- **Version:** The version of the channel.

Accounts & Sign In

Make the most of your TV. Choose account type and sign in to get new apps, recommendations movies and more.

Apps

You can view details about an app or other item listed. The information and controls available vary among different types of apps.

Device Preferences

See other chapters for more information about these settings. For example, for Picture settings, see [Picture on page 22](#).

Remotes & Accessories

To connect your remote through Bluetooth, before pairing your Bluetooth devices, make sure they're in pairing mode.

Device Preferences

About

- **System update:** We will provide software updates to continuously enhance your TV and correct any issues that may impact your user experience; therefore, we recommend that you keep your TV connected to the Internet to automatically receive updates when they are available.
- **Device name:** Change a name for your TV, also you can choose "Don't change", The name will be shown to devices that are available for sharing data.
- **Restart:** Restart your TV.
- **Status:** View system message, including: IP address, MAC address, Bluetooth address, Serial Number, etc.
- **Legal information:** Click to read the legal information.
- **Model / Version / Software version / Netflix ESN / Android security patch level / Kernel version / Build:** View related menu information.

Date & time

- **Automatic date & time:** Use network-provided time. You can also set the current time manually when **Off** is selected.
- **Set date:** Set the date.
- **Set time:** Set the time.
- **Set time zone:** Select your time zone.
- **Use 24-hour format:** Set the time to display in a 12 or 24-hour format.

Timer

- **Power On Timer Type:** Set the type Off, On, Once.
- **Power On Timer :** Set the clock for the time you want the TV to turn on automatically.
- **Power Off Timer Type:** Set the type Off, On, Once.
- **Power Off Timer :** Set the clock for the time you want the TV to turn off automatically.

Language

Adjust the default Language settings for the TV.

Keyboard

Adjust the default settings for the keyboard.

Inputs

You can see the state of devices that the TV connected: Connected Input, Standby Inputs and Not connected Input etc.

Consumer Electronic Control (CEC)



- **HDMI control:** Allow the TV to control HDMI devices.
- **Device auto power off:** Power off HDMI devices with the TV.
- **TV auto power on:** Power on the TV with HDMI device.

NOTES

- HDMI cables must be used to connect HDMI CEC-compatible devices to your TV.
- The HDMI CEC feature of the connected device must be turned on.
- If you connect an HDMI device that is not HDMI CEC-compatible, all the HDMI-CEC Control features do not work.

- Depending on the connected HDMI device, the HDMI-CEC Control feature may not work.
- **CEC Device List:** You will see the CEC device list if the TV accesses a CEC device.

Power

- **Sleep Timer:** Set the sleep timer to automatically turn the TV off within a specified time: off, 10 Minutes, 20 Minutes, 30 Minutes, 40 Minutes, 50 Minutes, 60 Minutes, 90 Minutes and 120 Minutes.
- **Picture off:** When you select this option, the screen will not display the picture. You can only listen to the audio. Press any button except the [] button, **Volume [+/-]** buttons and [] button to restore operation.
- **Switch off Timer:** Set the timer to automatically turn the TV off within a specified time: off, 30 Minutes, 60 Minutes, 90 Minutes, 120 Minutes, 150 Minutes, 180 Minutes, 210 Minutes and 240 Minutes.
- **No Signal Auto Power Off:** You can set how long after no signal, the TV will automatically shut down.

Picture

- **Picture Mode:** If you'd like to configure the settings for your picture, then there are seven types of picture modes available: **User, Standard, Vivid, Sport, Movie, Game, and Energy Saving**
- **Auto BackLight:** You can set to Off, Low, Middle or High.
- **BackLight:** Adjust Local Dimming, Backlight Level, Automatic Light Sensor and Minimum Backlight to change the overall brightness of the screen.
- **Brightness:** Adjust the Brightness level to generate lighter or darker images.
- **Contrast:** Adjust the Contrast level to increase or decrease how bright images appear.
- **Saturation:** Adjust the saturation of color settings.
- **HUE:** Adjust the hue of color settings.
- **Sharpness:** Adjust how sharp or soft edges of images appear.
- **Color Temperature:** Select a preset color temperature. Adjust how warm (red) or cool (blue) the white areas of an image appear.
- **Advanced Video:** Advanced settings for video.
- **Color Tuner:** Adjust the color tuner settings.
- **11 Point White Balance Correction:** Adjust the intensity of red, green and blue lights to view the true colors of all images in the picture.
- **Reset to Default:** Reset current picture settings to factory mode.

Sound

- **System sounds:** Turn on or off the default system sound.
- **Select formats:** Use the formats that your device reports supporting (recommended).
- **Sound Style:** Select a preset sound mode to suit the type of content you are listening to: **User, Standard, Vivid, Sports, Movie, Music, News.**
- **Balance:** Adjust the left and right speaker strength to optimize audio for a specific location.
- **Equalizer Detail:** Boost the volume at different frequencies.
- **ARC:** Select the speakers to ARC on or off.
- **Digital Output:** Select the digital audio output format that best suits the audio device type. Choose **PCM** if you have an amplifier that does not support Dolby Digital technology.
- **SPDIF Delay:** Adjust SPDIF Delay.
- **Auto Volume Control:** Turn on or off the Auto Volume Control.
- **DTS-StudioSound:** Enable DTS-StudioSound.
- **Reset to Default:** Reset current audio settings to factory mode.

Storage

See the information of the Internal shared storage.

Home screen

- **Customize channels:** Add or delete the app icon from Home screen.
- **Enable video previews:** Enables or disables the video previews.
- **Enable audio previews:** Enables or disables the audio previews.
- **Reorder apps / Reorder games:** Rearrange the Apps screen.
- **Android TV Home / Android TV Core Services:** See the information of open source software licences.

Store Mode

Turn on or off Store Mode.

Google

You can view permissions about accounts and limit the search results.

Chromecast built-in

You can view Open source licenses and Version number.

Screen saver

Enable and set Screen saver when the TV is idle.

Location

Your TV can use different modes to access location information. Each mode uses different sources to estimate the TV's location.

Usage & Diagnostics

Help improve Android performance by automatically sending diagnostics information.

Security & restrictions

Enables unknown sources, checking of apps installed for harmful behavior.

Accessibility

- **Audio Description:** Choose to leave the Audio Description feature On or Off.
- **Visually Impaired:** You can set Visually Impaired On or Off. The function can be used to meet the needs of visually impaired people.
- **Hearing Impaired:** You can set Hearing Impaired On or Off. The function can be used to meet the needs of hearing impaired people.
- **Captions(Antenna/Cable):** Displays and sets the closed captions.
- **Captions:** Displays and sets the TV closed captions.
- **High contrast text:** Improves contrast for visually impaired. The function can be used to meet the needs of visually impaired people.
- **Text to speech:** Lets you specify text-to-speech engine details and speech rate.
- **Accessibility shortcut:** You can set Accessibility shortcut On or Off.

- **TalkBack:** Controls spoken feedback for visually impaired users.
- **Switch Access:** Collects all of the text you type, except passwords. This includes personal data such as credit card numbers.

Reset

Reset your TV back to the factory default.

Parental Controls

The Parental Controls setting allows you to block content that is not appropriate for children to watch.

Turning Parental Controls On

1. The initial password for parental lock is: 1234
2. Using the D-pad on your remote, input the password.

You will see the other Parental Controls settings: **Channels Blocked, Program Restrictions, Inputs Blocked, Change PIN.**

- **Channels Blocked:** Block selected channels.
- **Program Restrictions:** Block programs by ratings. For more information about Ratings, See the following table.
- **Inputs Blocked** Block selected inputs.
- **Change PIN:** Change the PIN that you use to access Parental Controls.

NOTE

- If you forget your password, call the **Consumer Electronics Care Center**.

United States Ratings

Age	Defined as
TV-Y	All children
TV-Y7	Directed to older children
TV-G	General audience
TV-PG	Parental Guidance Suggested
TV-14	Parents strongly cautioned
TV-MA	Mature Audiences Only

United States (Film ratings)

Rating	Defined as
G	General audience
PG	Parental Guidance suggested
PG-13	Parents strongly cautioned
R	Restricted
NC-17	No one 17 and under permitted

Canada Ratings

Rating	Defined as
E	Programs except from classification
C	Children
C8+	Children 8 years and older
G	General programming that is suitable for all audiences
PG	Parental Guidance
14+	Viewers 14 years and older
18+	Adult Programming

Canada (French) Ratings

Rating	Defined as
E	Programs except from classification
G	General (appropriate for all ages and must contain little to no violence or sexual content)
8ans+	General but inadvisable for young children(could contain scenes disturbing to children under eight). Recommended for viewing with parent.
13ans+	Programming is appropriate for children 13 and older and may contain moderate violence, language and some sexual situations.
16ans+	Recommended for children 16 and older and may contain strong violence, language and sexual content.
18ans+	Programming intended for viewers that are 18 and older. Programming may contain extreme violence and graphic sexual content/pornography.

 **NOTE**

- All ratings that are higher than those you select are also blocked. For example, if you choose to block the PG-13 rating, then the higher ratings (R and NC-17) are automatically blocked too.

Apps

Numerous factory-installed apps are available for you to choose in personal preference.

Installing an App

To install an app:

1. From the Home screen, click on the **Apps** and select the **Get more apps**.
2. Use the navigation buttons on your remote to select the app that you want to install.
3. Select the **INSTALL**.

Removing an App

You can only delete apps that you've installed to the TV. Factory-installed apps can not be deleted.

To delete an app:

1. From the Apps screen, use the navigation buttons on your remote to select the app that you want to remove. Long press the **[OK]** button on your remote.
2. Click on **Uninstall**.
3. A dialog message displays that asks do you want to uninstall this app. Confirm and the icon is removed from the Apps screen.

NOTE

- If an app is deleted, the information related to that app is also removed.

Moving App Icons around

To move an app:

1. From the Apps screen, use the navigation buttons on your remote to select the app that you want to move. Long press the **[OK]** button on your remote.
2. Click **Move**.
3. Use the navigation buttons on your remote to move the location of app. Press the **[OK]** button to confirm.

MultiMediaPlayer

MultiMediaPlayer is a central location for you to view or listen to different types of content (for example, your photos, music and movies) through the following methods:

- A USB thumb drive or hard drive
- Compatible mobile phone, tablet or other personal devices: You can stream movies, music and photos that are stored on Compatible personal device and play or view the content on your TV.

File formats that may be supported

NOTE

- Due to differences in programming tools and other factors, some of the file formats that are listed may or may not be supported.

Medium	File Format
Video	.avi (Mpeg2, H.264), .mkv (H.264, H.265), .mpg (Mpeg2), .ts (H.264, H.265)
Picture	.jpg
Music	.mp3

Browsing Content

You have two ways to enter **MultiMediaPlayer**:

- Insert a USB device, press the [**APPS**] button on your remote, and browse down to click **MultiMediaPlayer**.
- When your USB device is connected to the TV, select **Apps** on home screen to add **MultiMediaPlayer** to favorites, then you can select **MultiMediaPlayer** to enter.

To browse content based on the type that you wish to access:

1. Navigate to the appropriate menu tab on the screen and select **Video**, **Photo**, **Music** or **Text**.
2. Click on the name of the folder that contains your content.
3. Make your selection to play or view the content.

If you want to close out of the **MultiMediaPlayer** center, press the [**↶**] button on your remote.

Quick Problem-Solving Tips

When you experience an issue with your TV, turn it off and on again. If this does not resolve the problem, then refer to the tips below. If the problem is still not resolved, then contact us.

ISSUES	POSSIBLE SOLUTIONS
No sound or picture	<ul style="list-style-type: none"> • Check if the power cord is plugged into a powered AC outlet. • Press the [] button on the remote control to activate the unit from 'Standby' mode. • Check to see if the LED light is on or not. If it is, then the TV is receiving power.
I have connected an external source to my TV and I get no picture and/or sound	<ul style="list-style-type: none"> • Check for the correct output connection on the external source and for the correct input connection on the TV. • Make sure you have made the correct selection for the input mode for the incoming signal.
When I turn on my TV, there is a delay for a few seconds before the picture appears. Is this normal?	<ul style="list-style-type: none"> • Yes, this is normal. The TV is initializing and searching for previous setting information.
The picture is normal but there is no sound	<ul style="list-style-type: none"> • Check the volume settings. • Check if 'Mute' mode is set to On.
Sound but no picture or black and white picture	<ul style="list-style-type: none"> • If the picture is black and white, unplug the TV from the AC outlet and replug it after 60 seconds. • Check that the Color is set to 50 or higher. • Try different TV channels.
The sound and/or picture is distorted or appears wavy	<ul style="list-style-type: none"> • An electric appliance may be affecting the TV. Turn off any appliances that are nearby and move it farther away from the TV. • Insert the power plug of the TV set into another power outlet.
The sound and picture is blurry or cuts out	<ul style="list-style-type: none"> • If using an external antenna, check the direction, position and connection of the antenna. • Adjust the direction of your antenna or reset or fine tune the channel.
A horizontal or vertical stripe appears on the picture and/or the picture is shaking	<ul style="list-style-type: none"> • Check if there is an appliance or electric tool nearby that is causing interference.
The plastic cabinet makes a "clicking" type of sound	<ul style="list-style-type: none"> • The 'click' sound can occur when the temperature of the television changes. This change causes the television cabinet to expand or contract, which makes the sound. This is normal and the TV is OK.
The remote control does not work	<ul style="list-style-type: none"> • Confirm that TV still has power and is operational. • Change the batteries in the remote control. • Check if the batteries are correctly installed.

NOTE

- For usage in Mexico, operation of this equipment is subject to the following two conditions: 1) it is possible that this device doesn't cause any detrimental interference and 2) this device must take any kind of interference, including that which may cause its malfunctioning.