



### English

- Read **Safety and Reference**.
- For the power supply and power consumption, refer to the label attached to the product.

### Български

- Прочетете **Безопасност и справки**.
- Направете справка с етикета на продукта за електрозахранването и консумацията на енергия.

### Français

- Lire le document **Sécurité et référence**.
- Reportez-vous à l'étiquette apposée sur le téléviseur pour connaître l'alimentation et la consommation électriques.

### Ελληνικά

- Ανάγνωση **Ασφάλεια και αναφορά**.
- Για πληροφορίες σχετικά με την τροφοδοσία και την κατανάλωση ενέργειας, δείτε την ετικέτα του προϊόντος.

### Italiano

- Consultare la sezione **Sicurezza e informazioni di riferimento**.
- Per l'alimentazione e il consumo di energia, consultare l'etichetta applicata sul prodotto.

### Português

- Consulte o manual de **Segurança e Referência**.
- No que respeita à fonte de alimentação e ao consumo de energia, consulte a etiqueta mostrada no produto.

### Русский

- Прочтите **Руководство по технике безопасности**.
- Требования параметров электропитания и значения потребляемой мощности указаны на информационном лейбле на задней крышке изделия.

### Hrvatski

- Pročitajte **Sigurnost i reference**.
- Informacije o napajanju i potrošnji energije potražite na oznaci koja se nalazi na proizvodu.

### Español

- Leer **Seguridad y Referencias**.
- Para obtener información acerca de la fuente de alimentación y el consumo de energía, consulte la etiqueta del producto.

### Українська

- Прочитайте **Правила безпеки та довідкова інформація**.
- Відомості щодо подачі живлення і споживання електроенергії дивіться на наліпці на виробі.

### العربية

- قراءة السلامة والمرجع.
- لمعرفة المزيد حول مصدر الإمداد بالطاقة والمعايير استهلاك الطاقة، راجع الملصق الموجود على المنتج.

### Česky

- Přečtěte si část **Bezpečnost a reference**.
- Informace o napájení a příkonu naleznete na štítku připevněném k výrobku.

### Deutsch

- **Sicherheitshinweise und Referenzen:** Bitte lesen!
- Informationen zur Stromversorgung und zum Stromverbrauch sind dem Etikett auf dem Gerät zu entnehmen.

### Magyar

- Lásd: **Biztonsági óvintézkedések**.
- A tápellátásra és az áramfogyasztásra vonatkozó adatok a készülékre ragasztott címkén található.

### Polski

- Przeczytaj **Zasady bezpieczeństwa i informacje dodatkowe**.
- Dokładne informacje o zasilaniu i zużyciu energii są umieszczone na etykietce znajdującej się na produkcie.

### Română

- Citiți **Siguranță și referințe**.
- Pentru sursa de alimentare și consumul de energie, consultați eticheta atașată pe produs.

### Srpski

- Pročitajte **Bezbednost i informacije**.
- Da biste saznali informacije u vezi sa napajanjem i potrošnjom energije, pogledajte oznaku na proizvodu.

### Slovenščina

- Preberite **Varnostne informacije in napotki**.
- Podatke o napajanju in porabi energije si oglejte na nalepki izdelka.

### Türkçe

- **Güvenlik ve Referans** bölümünü okuyun.
- Güç kaynağı ve güç tüketimi için ürüne yapıştirilmiş olan etikete bakın.

### O'zbekcha

- **Xavfsizlik bo'yicha ko'rsatmalar va havolalar** o'qib chiqing.
- Quvvat ta'minoti va quvvat iste'moli uchun mahsulotga yopishtirilgan yorliqqa qarang.

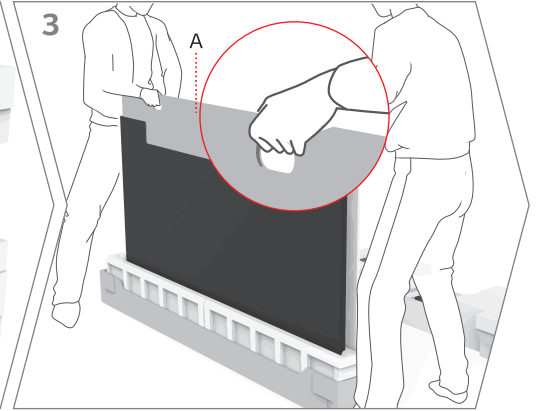
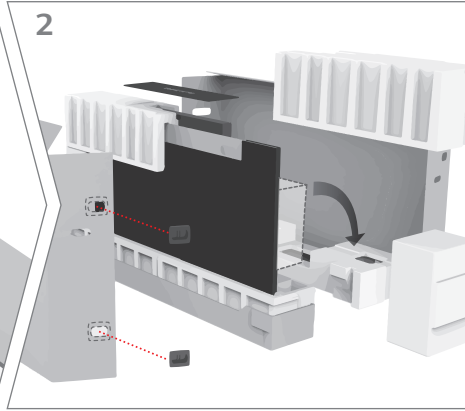
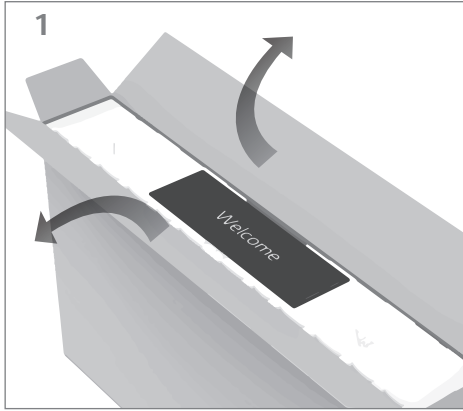

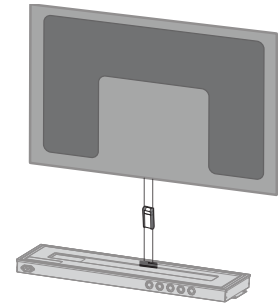
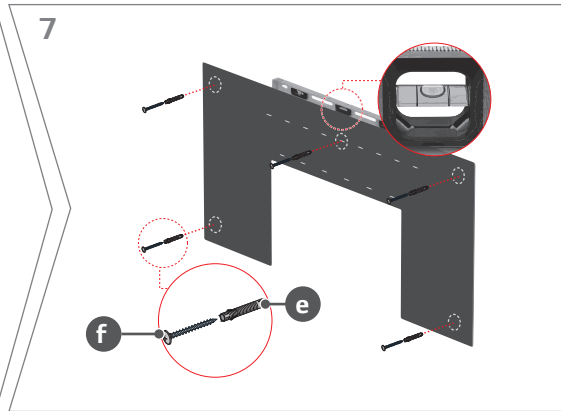
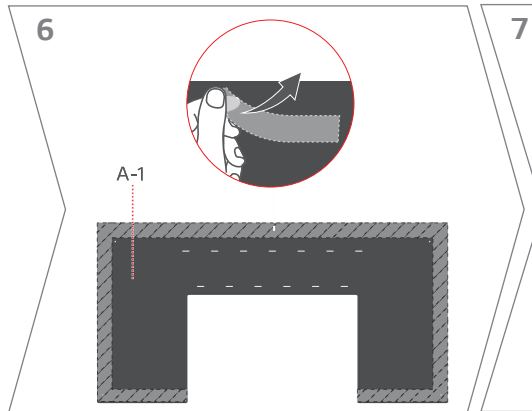
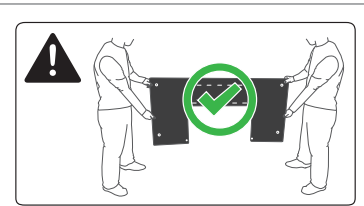
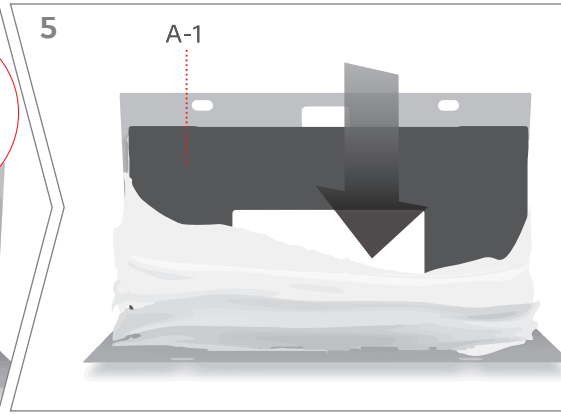
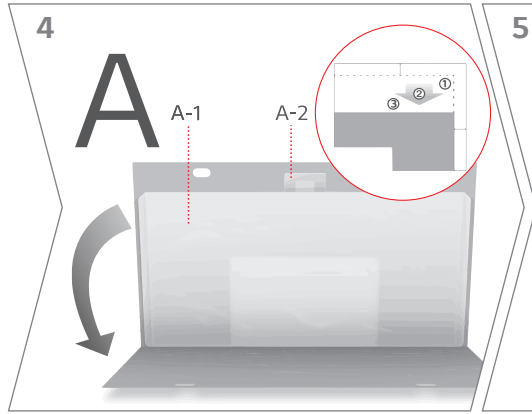

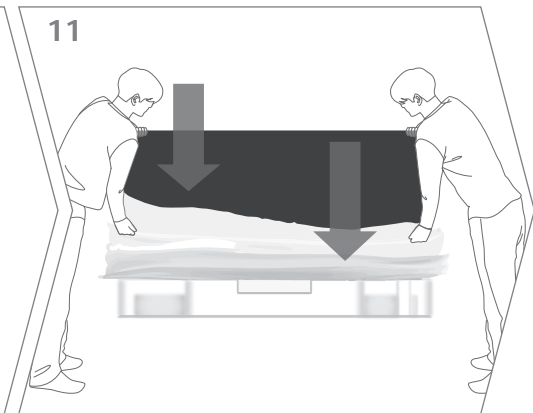
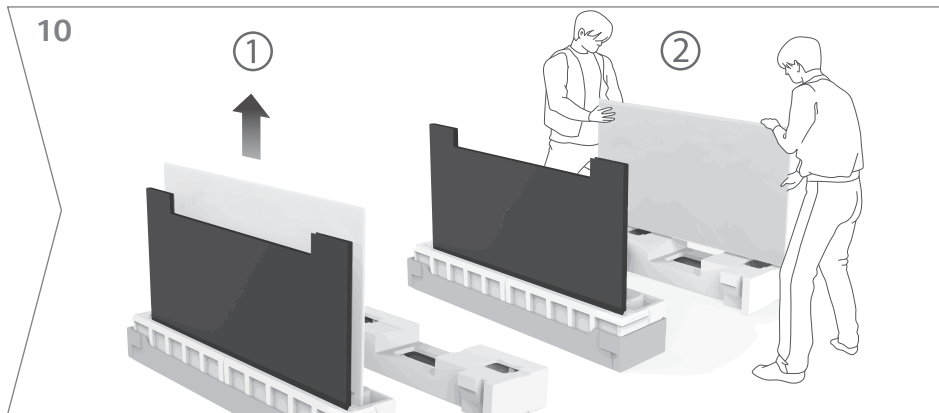
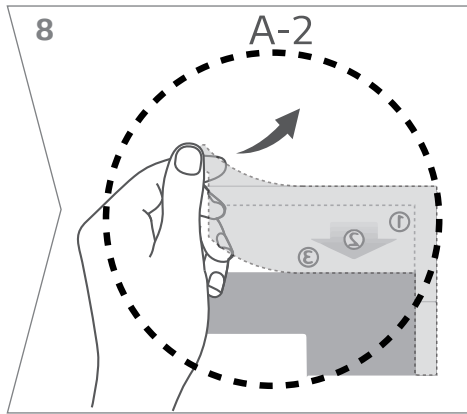

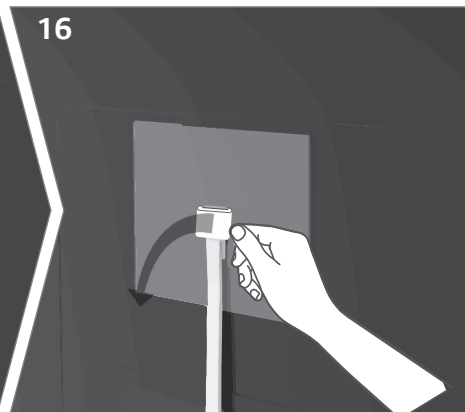
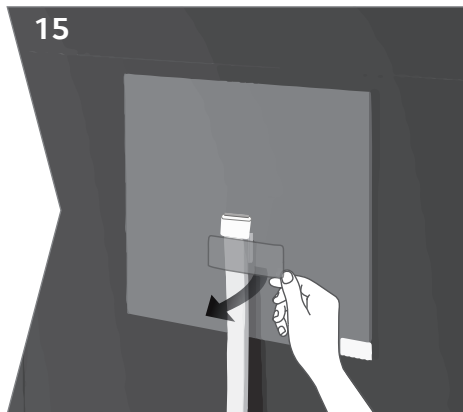
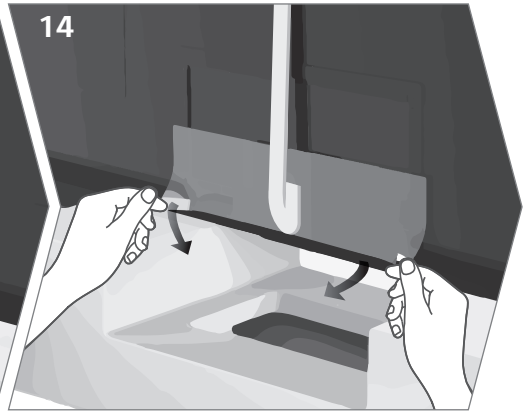
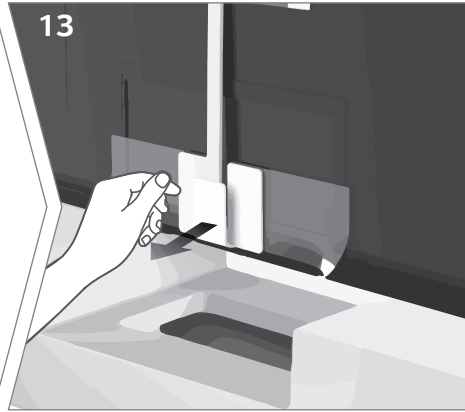
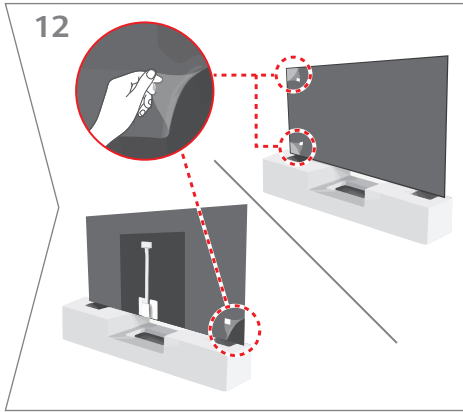



18

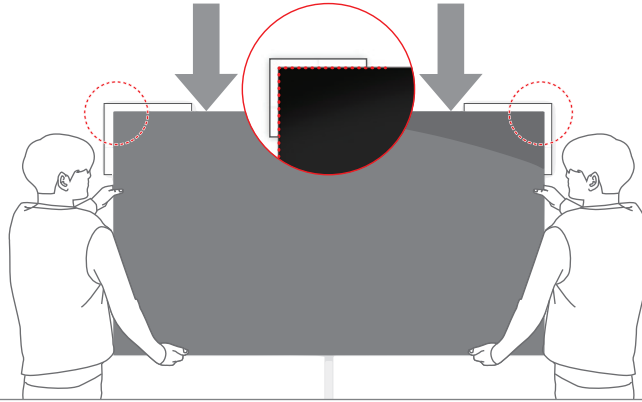

19

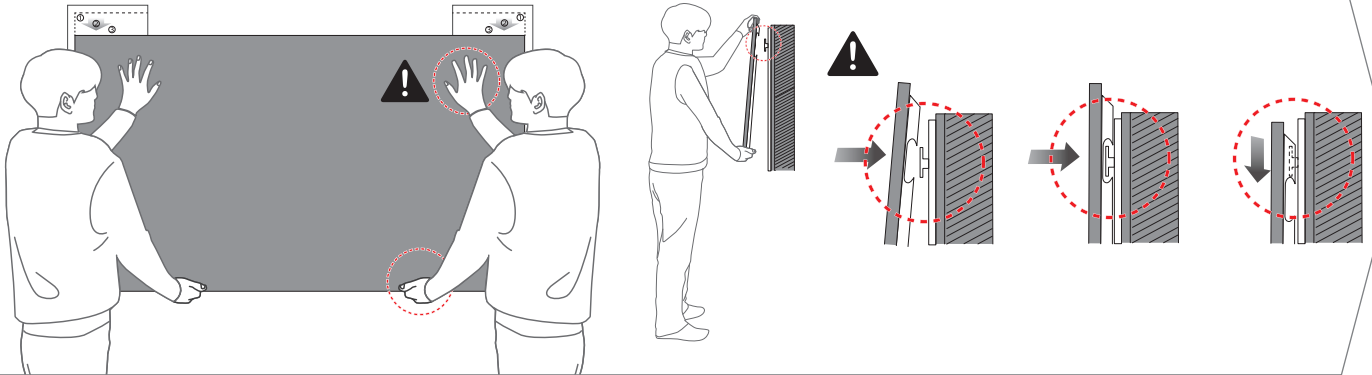



20

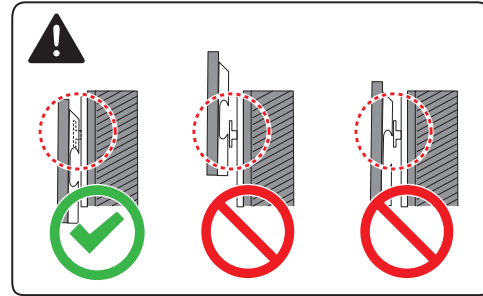
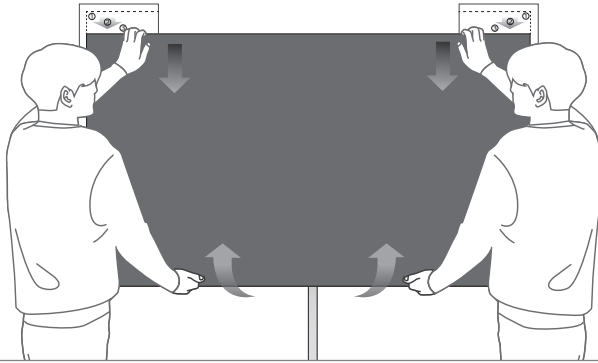

21

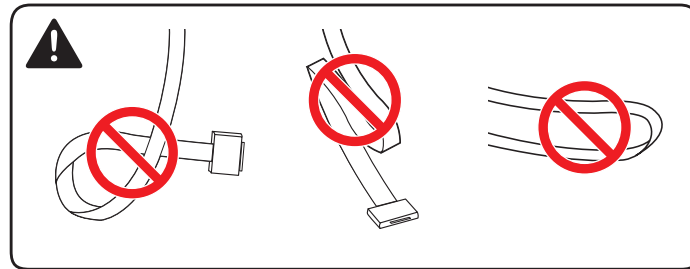
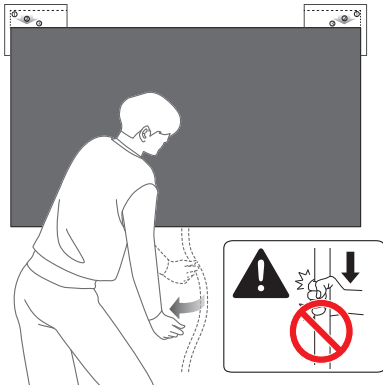



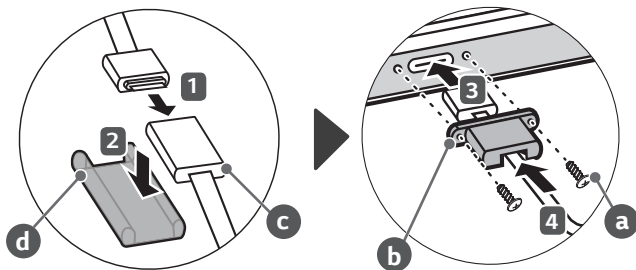
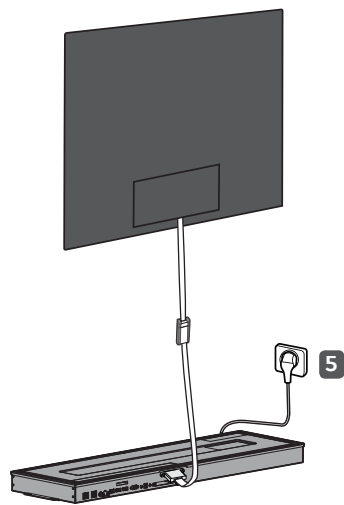



22

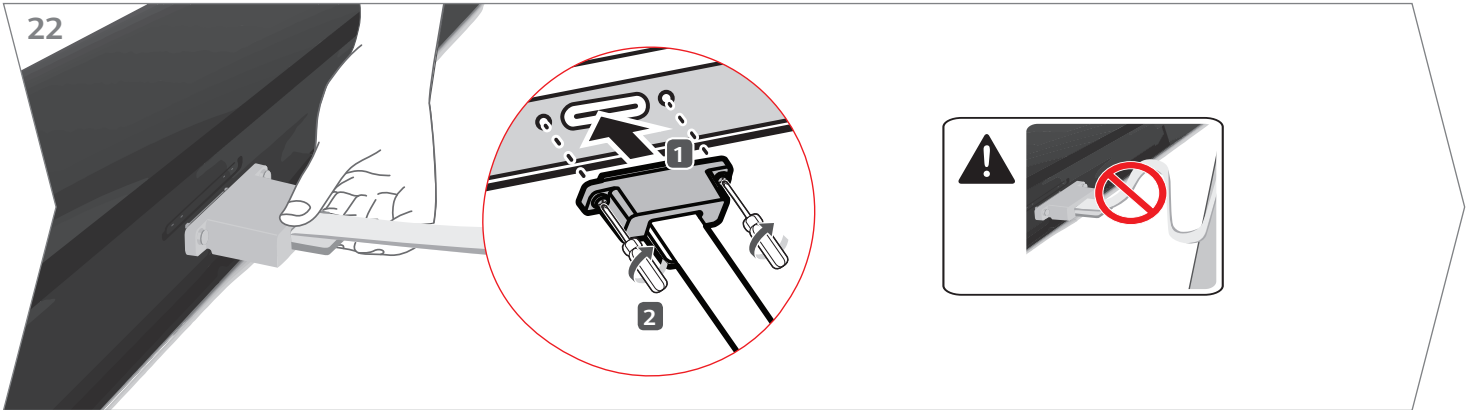

23

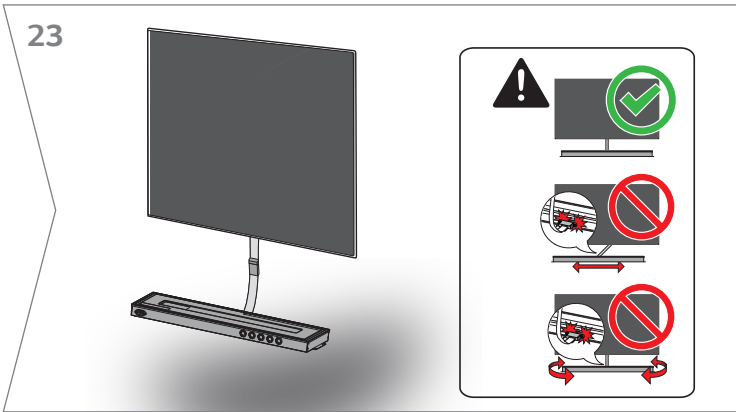

24

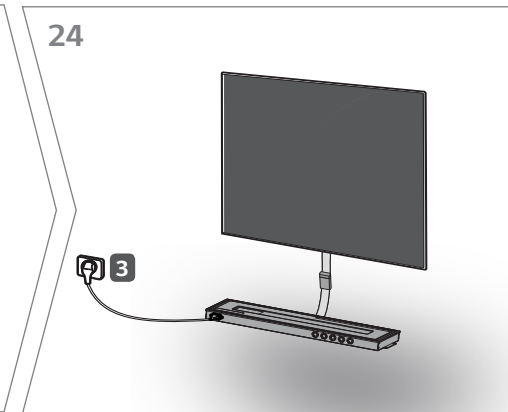

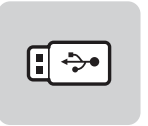
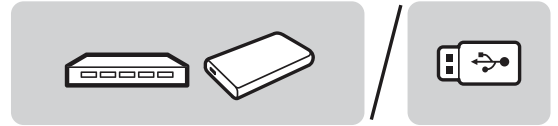
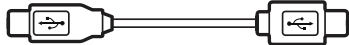
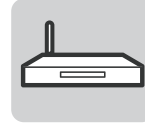
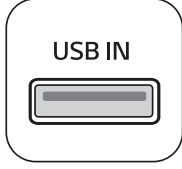
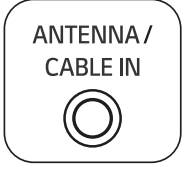
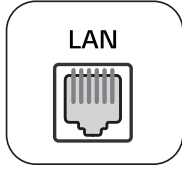
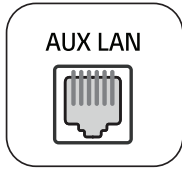
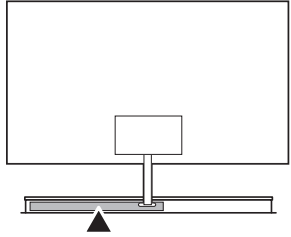

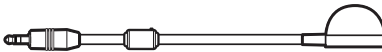
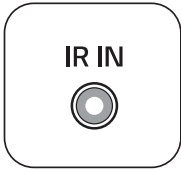
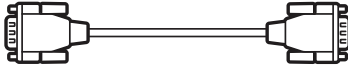
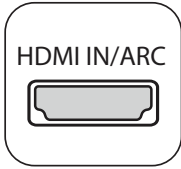
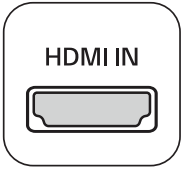
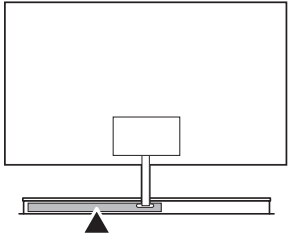

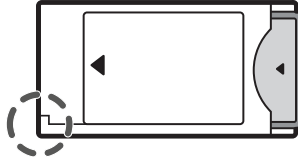
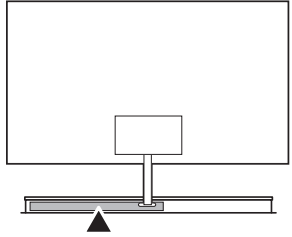

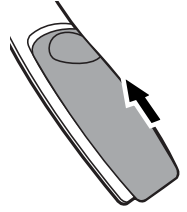
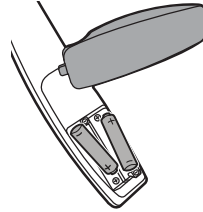
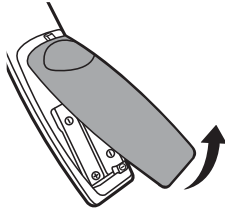
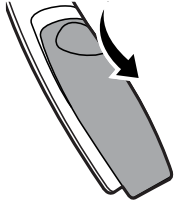
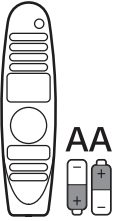



1

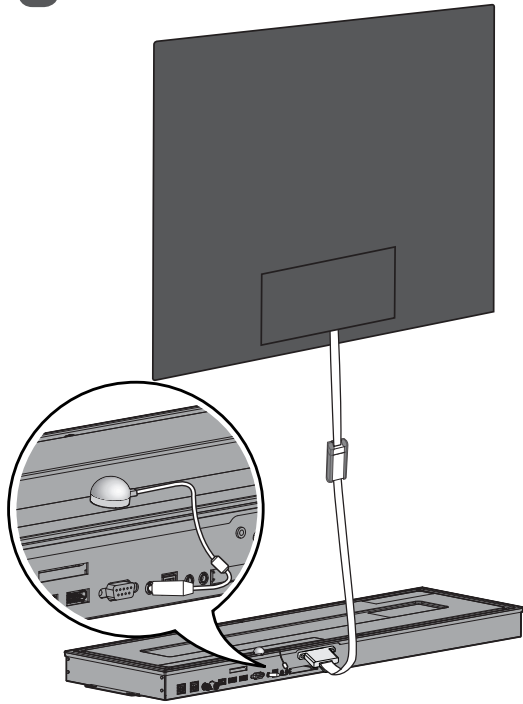

2

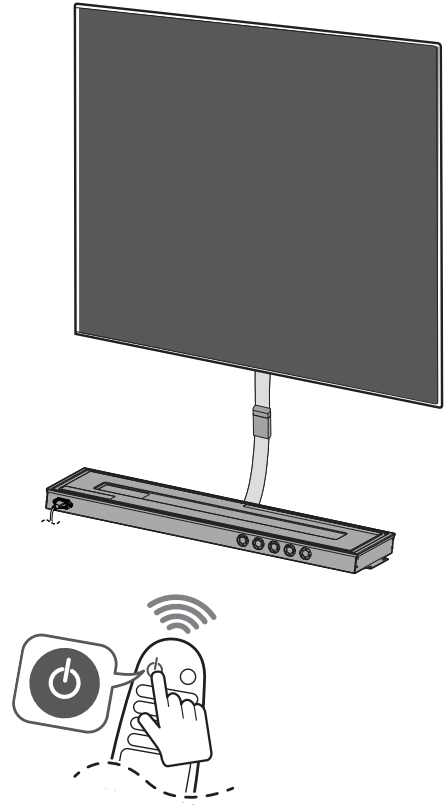

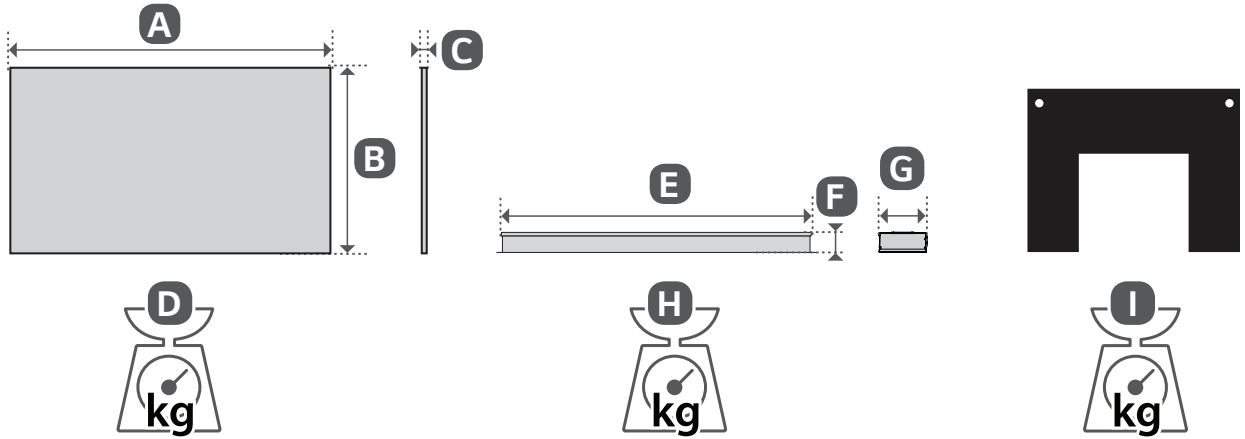

|                   | A    | B   | C    | D    | E                         | F    | G     | H    | I   |
|-------------------|------|-----|------|------|---------------------------|------|-------|------|-----|
|                   | (mm) |     |      | (kg) | (mm)                      |      |       | (kg) |     |
| 65WT980H0ZA       | 1446 | 823 | 3.85 | 6.7  | 793.8                     | 48.5 | 230.2 | 3.5  | 2.3 |
| Power Requirement |      |     |      |      | AC 100-240 V ~ 50 / 60 Hz |      |       |      |     |





# OWNER'S MANUAL

Safety and Reference

# OLED TV

---

Please read this manual carefully before operating your set and retain it for future reference.



\* S A C 3 5 9 7 4 0 1 0 \*

(2002-REV01)

[www.lg.com](http://www.lg.com)

Copyright © 2019 LG Electronics Inc. All Rights Reserved.

# Warning! Safety Instructions



**CAUTION** : TO REDUCE THE RISK OF ELECTRIC SHOCK, DO NOT REMOVE COVER (OR BACK). NO USER-SERVICEABLE PARTS INSIDE. REFER TO QUALIFIED SERVICE PERSONNEL.

 This symbol is intended to alert the user to the presence of uninsulated "dangerous voltage" within the product's enclosure that may be of sufficient magnitude to constitute a risk of electric shock to persons.

 This symbol is intended to alert the user to the presence of important operating and maintenance (servicing) instructions in the literature accompanying the appliance.

**WARNING** : TO REDUCE THE RISK OF FIRE AND ELECTRIC SHOCK, DO NOT EXPOSE THIS PRODUCT TO RAIN OR MOISTURE.

- TO PREVENT THE SPREAD OF FIRE, KEEP CANDLES OR OTHER ITEMS WITH OPEN FLAMES AWAY FROM THIS PRODUCT AT ALL TIMES.
  - **Do not place the TV and/or remote control in the following environments:**
    - Keep the product away from direct sunlight.
    - An area with high humidity such as a bathroom.
    - Near any heat source such as stoves and other devices that produce heat.
    - Near kitchen counters or humidifiers where they can easily be exposed to steam or oil.
    - An area exposed to rain or wind.
    - Do not expose to dripping or splashing and do not place objects filled with liquids, such as vases, cups, etc. on or over the apparatus (e.g., on shelves above the unit).
    - Near flammable objects such as gasoline or candles, or expose the TV to direct air conditioning.
    - Do not install in excessively dusty places.
- Otherwise, this may result in fire, electric shock, combustion/explosion, malfunction or product deformation.

## • Ventilation

- Install your TV where there is proper ventilation. Do not install in a confined space such as a bookcase.
- Do not install the product on a carpet or cushion.
- Do not block or cover the product with cloth or other materials while unit is plugged in.
- Take care not to touch the ventilation openings. When watching the TV for a long period, the ventilation openings may become hot.
- Protect the power cord from physical or mechanical abuse, such as being twisted, kinked, pinched, closed in a door, or walked upon. Pay particular attention to plugs, wall outlets, and the point where the cord exits the device.
- Do not move the TV whilst the Power cord is plugged in.
- Do not use a damaged or loosely fitting power cord.
- Be sure to grasp the plug when unplugging the power cord. Do not pull on the power cord to unplug the TV.
- Do not connect too many devices to the same AC power outlet as this could result in fire or electric shock.

## • Disconnecting the Device from the Main Power

- The power plug is the disconnecting device. In case of an emergency, the power plug must remain readily accessible.
- Do not let your children climb or cling onto the TV. Otherwise, the TV may fall over, which may cause serious injury.
- **Outdoor Antenna Grounding** (Can differ by country):
  - If an outdoor antenna is installed, follow the precautions below. An outdoor antenna system should not be located in the vicinity of overhead power lines or other electric light or power circuits, or where it can come in contact with such power lines or circuits as death or serious injury can occur. Be sure the antenna system is grounded to provide some protection against voltage surges and built-up static charges. Section 810 of the National Electrical Code (NEC) in the U.S.A. provides information with respect to proper grounding of the mast and supporting structure, grounding of the lead-in wire to an antenna discharge unit, size of grounding conductors, location of antenna discharge unit, connection to grounding electrodes and requirements for the grounding electrode. Antenna grounding according to the National Electrical Code, ANSI/NFPA 70

- **Grounding** (Except for devices which are not grounded.)
    - TV with a three-prong grounded AC plug must be connected to a three-prong grounded AC outlet. Ensure that you connect the earth ground wire to prevent possible electric shock.
  - Never touch this apparatus or antenna during a lightning storm. You may be electrocuted.
  - Make sure the power cord is connected securely to the TV and wall socket if not secured damage to the Plug and socket may occur and in extreme cases a fire may break out.
  - Do not insert metallic or inflammable objects into the product. If a foreign object is dropped into the product, unplug the power cord and contact customer service.
  - Do not touch the end of the power cord while it is plugged in. You may be electrocuted.
  - **If any of the following occur, unplug the product immediately and contact your local customer service.**
    - The product has been damaged.
    - If water or another substance enters the product (like an AC adapter, power cord, or TV).
    - If you smell smoke or other odors coming from the TV.
    - When lightning storms or when unused for long periods of time.

Even if the TV is turned off by the remote control or power button, AC power source is still connected to the unit if it is not unplugged. (Depending on model)
  - Do not use high voltage electrical equipment near the TV (e.g., a bug zapper). This may result in product malfunction.
  - Do not attempt to modify this product in any way without written authorization from LG Electronics. Accidental fire or electric shock can occur. Contact your local customer service for service or repair. Unauthorized modification could void the user's authority to operate this product.
  - Use only an authorized attachments / accessories approved by LG Electronics. Otherwise, this may result in fire, electric shock, malfunction, or product damage.
  - Never disassemble the AC adapter or power cord. This may result in fire or electric shock.
  - Handle the adapter carefully to avoid dropping or striking it. An impact could damage the adapter.
  - To reduce the risk of fire or electrical shock, do not touch the TV with wet hands. If the power cord prongs are wet or covered with dust, dry the power plug completely or wipe dust off.
- **Batteries**
    - Store the accessories (battery, etc.) in a safe location out of the reach of children.
    - Do not short circuit, disassemble, or allow the batteries to overheat. Do not dispose of batteries in a fire. Batteries should not be exposed to excessive heat.
  - **Moving**
    - When moving, make sure the product is turned off, unplugged, and all cables have been removed. It may take 2 or more people to carry larger TVs. Do not press or put stress on the front panel of the TV. Otherwise, this may result in product damage, fire hazard or injury.
  - Keep the packing anti-moisture material or vinyl packing out of the reach of children.
  - Do not allow an impact shock, any objects to fall into the product, and do not drop anything onto the screen.
  - Do not press strongly upon the panel with a hand or a sharp object such as a nail, pencil, or pen, or make a scratch on it. It may cause damage to the screen.
  - **Cleaning**
    - When cleaning, unplug the power cord and wipe gently with a soft/dry cloth. Do not spray water or other liquids directly on the TV. Do not clean your TV with chemicals including glass cleaner, any type of air freshener, insecticide, lubricants, wax (car, industrial), abrasive, thinner, benzene, alcohol etc., which can damage the product and/or its panel. Otherwise, this may result in electric shock or product damage.

## Preparing

- If the TV is turned on for the first time after it was shipped from the factory, initialization of the TV may take a few minutes.
- Image shown may differ from your TV.
- Your TV's OSD (On Screen Display) may differ slightly from that shown in this manual.
- The available menus and options may differ from the input source or product model that you are using.
- New features may be added to this TV in the future.
- The device must be easily accessed to a location outlet near the access. Some devices are not made by turning on / off button, turning off the device and unplugging the power cord.
- The items supplied with your product may vary depending on the model.
- Product specifications or contents of this manual may be changed without prior notice due to upgrade of product functions.
- For an optimal connection, HDMI cables and USB devices should have bezels less than 10 mm thick and 18 mm width. Use an extension cable that supports USB 2.0 if the USB cable or USB memory stick does not fit into your TV's USB port.

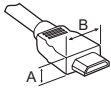

\* A ≤ 10 mm

\* B ≤ 18 mm

- Use a certified cable with the HDMI logo attached.
- If you do not use a certified HDMI cable, the screen may not display or a connection error may occur. (Recommended HDMI Cable Types)
  - Ultra High-Speed HDMI<sup>®</sup>/™ Cable (3 m or less)

## Separate Purchase

Separate purchase items can be changed or modified for quality improvement without any notification. Contact your dealer to buy these items. These devices only work with certain models.

The model name or design may be changed depending on the upgrade of product functions, manufacturer's circumstances or policies.

The manufacturer shall not be held responsible for any injuries, damages, or quality issues that may arise if an item that is not listed below is purchased separately and used.

### Magic Remote Control

AN-MR18HA

Check whether your TV model supports Bluetooth in the Wireless Module Specification to verify whether it can be used with the Magic Remote.

## Lifting and moving the TV

Please note the following advice to prevent the TV from being scratched or damaged and for safe transportation regardless of its type and size.

- It is recommended to move the TV in the box or packing material that the TV originally came in.
- Before moving or lifting the TV, disconnect the power cord and all cables.
- When holding the TV, the screen should face away from you to avoid damage.



- Hold the top and bottom of the TV frame firmly. Make sure not to hold the transparent part.

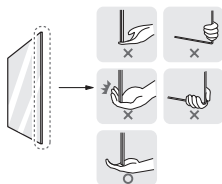

- When transporting a large TV, there should be at least 2 people.
- When transporting the TV by hand, hold the TV as shown in the following illustration.

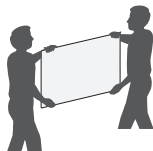

- When transporting the TV, do not expose the TV to jolts or excessive vibration.
- When transporting the TV, keep the TV upright, never turn the TV on its side or tilt towards the left or right.
- Do not apply excessive pressure to cause flexing / bending of frame chassis as it may damage the screen.
- When handling the TV, be careful not to damage.





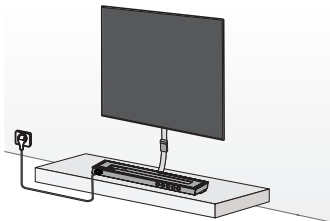

- Avoid touching the screen at all times, as this may result in damage to the screen.
- When supported cable is not long enough to connect TV set with Companion Box (AV box), you can use an extension cable.
- Please do not pile the stuff up or press strongly. This may result in product damage or degradation.

## Mounting on a wall

- If you are attaching the TV to other building materials, please contact qualified personnel to install the wall mount.



- Do not apply foreign substances (oils, lubricants, etc.) to the screw parts when assembling the product. (Doing so may damage the product.)
- Do not use any unapproved items to ensure the safety and product life span.
- Any damage or injuries caused by using unapproved items are not covered by the warranty.
- Make sure that the screws are inserted correctly and fastened securely. (If they are not fastened securely enough, the TV may tilt forward after being installed.) Do not use too much force and over tighten the screws; otherwise screw may be damaged and not tighten correctly.

| Provided item   |   |
|---|---|
|  |  |
| Wall mount  | Punching Guide  |
|  |  |
| Wall mounting screw<br>Ø 5 x L65  | Wall mounting anchor  |
|  |   |
| Wall mounting screw for wood<br>Ø 3 x L18   |   |

- Check the material of the wall and the thickness of the finishing.
- Use the Wall mount anchor for wall material of concrete, light concrete, strong natural stone, soft natural stone masonry brick and hollow block that do not crack.

| Wall material          | Tools  | Wall width         |
|------------------------|--|--------------------|
| Concrete               | Wall mounting anchor, Wall mounting screw, Ø 3/6/8 mm<br>Drill bit | 70 mm              |
| Brick                  |  |                    |
| Natural stone          |  |                    |
| Metal Panel            |  |                    |
| Plywood                | Wall mounting screw, Ø 1.8 mm<br>Drill bit                         | 30 mm              |
| EPS Panel              |  | Penetrate the wall |
| Plasterboard + Plywood |  | 30 mm              |

- When installing on a gypsum board or medium-density fiberboard (MDF) wall, fasten the screws to the wooden pillars that support the wall. If there are no wooden pillars, check the distance from the inner wall before installing.
  - 30 mm or below: Install directly on the inner wall using a 65 mm screw.
  - 30 mm or above: Install using a separate hanger.

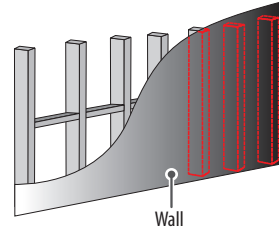

- When installing the wall mount, check the positions of the wooden studs using a stud finder. Then, fasten the screws on at least two separate studs before proceeding.

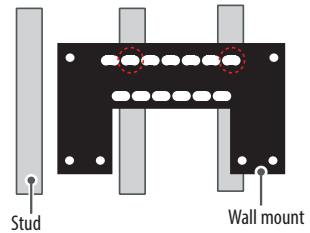

- When installing the product on wall material not designated, install the product so that each location can withstand the pull out load of 70 kgf (686 N) and shear load of 100 kgf (980 N) or above.
- Use the Ø 8 mm drill bit for concrete and hammer (Impact) drill.

### Tools you will need

- Phillips head + driver (manual or motorized), Ø 3/6/8 mm Drill bit, Level, Stud finder, Drill

## How to attach to masonry walls

Please follow the below direction.

- 1 Use a drill bit  $\varnothing$  8 mm to drill a hole for the anchor location within a depth of 80 mm to 100 mm.

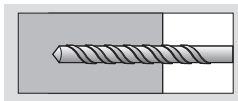

- 2 Clean the drilled hole.

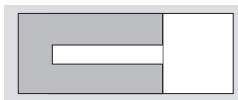

- 3 Insert the sealed wall mounting anchor to the hole. (When inserting the anchor, use a hammer.)

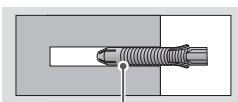

Wall mounting anchor

- 4 Set the wall mount on the wall by aligning to the location of the hole. And, set the angle adjusting part to face upward.

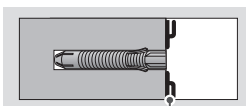

Wall mount

- 5 Align the wall mounting screw to the hole and tighten it. Then, fasten the screws at torque of 45 kgf/cm to 60 kgf/cm.

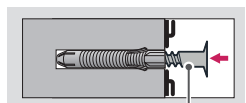

Wall mounting screw

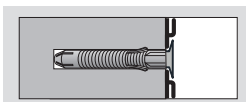

- When mounting a TV on the wall, make sure not to install the TV with the power and signal cables hanging from the back of the TV.
- Do not install this product on a wall if it could be exposed to oil or oil mist. This may damage the product and cause it to fall.
- Make sure that children do not climb on or hang on the TV.
- Use a platform or cabinet that is strong and large enough to support the TV securely.
- When installing the product, first check that the wall is strong enough. Use the anchors and screws provided.
  - If you use anchors and screws that are not specified by the manufacturer, they may not hold the weight of the product, causing safety issues.
- Be sure to use the accessory cable provided. Otherwise, friction between the product and the wall may cause damage to the connector.
- When drilling holes into the wall, make sure you use a drill and drill bit with the specified diameter. Ensure that you also follow the instructions regarding the depth of the holes.
  - Otherwise, the product may be installed incorrectly and cause safety issues.
- Wear safety gloves when installing the product. Do not use your bare hands.
  - Otherwise, it may cause personal injury.
- If some parts of the wall mount do not touch the wall after it is attached, use the double-sided tape included in the accessory box to stick the mount to the wall.
- If some parts of the wall mount do not touch the wall after using the wall mounting screws for wood, use the remaining screws.
- Be sure to use only the exclusive wall mounting screws provided as accessories.
- If you want to connect the TV Cable is connected to the back panel partition, please use the enclosed Punching Guide.

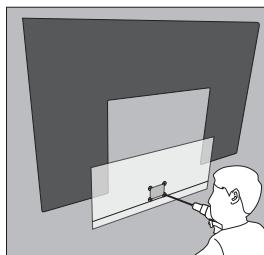



- If the cable that connects the panel to the Companion Box (AV box) is to be embedded in the wall, it is recommended to make use of a conduit as shown in the figure below. The conduit must be installed in accordance with the wall-embedded installation regulations of each country. It is recommended that a product made of metallic material with internal dimensions at least 70 mm wide and 20 mm thick be used.

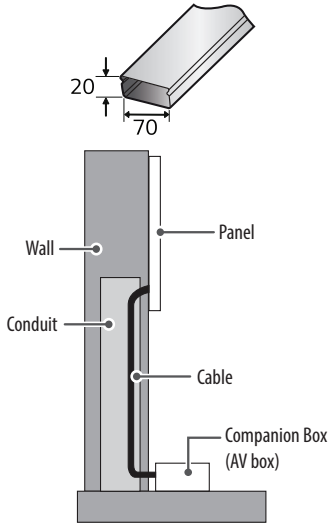

## Connections

Connect various external devices to the TV and switch input modes to select an external device. For more information of external device's connection, refer to the manual provided with each device.

### Antenna/Cable

Connect the TV to a wall antenna socket with an RF cable (75  $\Omega$ ).

- Use a signal splitter to use more than 2 TVs.
- If the image quality is poor, install a signal amplifier properly to improve the image quality.
- If the image quality is poor with an antenna connected, try to realign the antenna in the correct direction.
- An antenna cable and converter are not supplied.
- For a location that is not supported with ULTRA HD broadcasting, this TV cannot receive ULTRA HD broadcasts directly.

### Satellite dish

Connect the TV to a satellite dish to a satellite socket with a satellite RF cable (75  $\Omega$ ). (Depending on model)

### CI module

View the encrypted (pay) services in digital TV mode. (Depending on model)

- Check if the CI module is inserted into the PCMCIA card slot in the right direction. If the module is not inserted properly, this can cause damage to the TV and the PCMCIA card slot.
- If the TV does not display any video and audio when CI+ CAM is connected, please contact to the Terrestrial/Cable/Satellite Service Operator.





## Other connections

Connect your TV to external devices. For the best picture and audio quality, connect the external device and the TV with an HDMI cable. Some separate cables are not provided..

### HDMI

- Supported HDMI Audio format:  
(Depending on model)  
DTS (44.1 kHz / 48 kHz / 88.2 kHz / 96 kHz),  
DTS HD (44.1 kHz / 48 kHz / 88.2 kHz / 96 kHz / 176.4 kHz / 192 kHz),  
True HD (48 kHz),  
Dolby Digital / Dolby Digital Plus (32 kHz / 44.1 kHz / 48 kHz),  
PCM (32 kHz / 44.1 kHz / 48 kHz / 96 kHz / 192 kHz)

-  →  () → [Picture] → [Additional Settings] → [HDMI ULTRA HD Deep Colour]

- On: Support 4K @ 50/60 Hz (4:4:4, 4:2:2, 4:2:0)
- Off: Support 4K @ 50/60 Hz 8 bit (4:2:0)

If the device connected to Input Port also supports ULTRA HD Deep Colour, your picture may be clearer. However, if the device doesn't support it, it may not work properly. In that case, change the TV's [HDMI ULTRA HD Deep Colour] setting to Off.

### USB

Some USB Hubs may not work. If a USB device connected through a USB Hub is not detected, connect it directly to the USB port on the TV.

- It is recommended that you use a USB hub or USB HDD with a power supply. (If the power supplied is not sufficient, the USB storage device may not be detected properly.)
- It is recommended that you use an external USB HDD with a rated voltage of 5 V or less and a rated current of 500 mA or less.

## External Devices

Available external devices are: Blu-ray player, HD receivers, DVD players, VCRs, audio systems, USB storage devices, PC, gaming devices, and other external devices.

- The external device connection may differ from the model.
- Connect external devices to the TV regardless of the order of the TV port.
- Refer to the external equipment's manual for operating instructions.
- If you connect a gaming device to the TV, use the cable supplied with the gaming device.
- In PC mode, there may be noise associated with the resolution, vertical pattern, contrast or brightness. If noise is present, change the PC output to another resolution, change the refresh rate to another rate or adjust the brightness and contrast on the PICTURE menu until the picture is clear.
- In PC mode, some resolution settings may not work properly depending on the graphics card.
- If ULTRA HD content is played on your PC, video or audio may become disrupted intermittently depending on your PC's performance.
- When connecting via a wired LAN, it is recommended to use a CAT 7 cable. (Only when **LAN** port is provided.)

## External Speakers

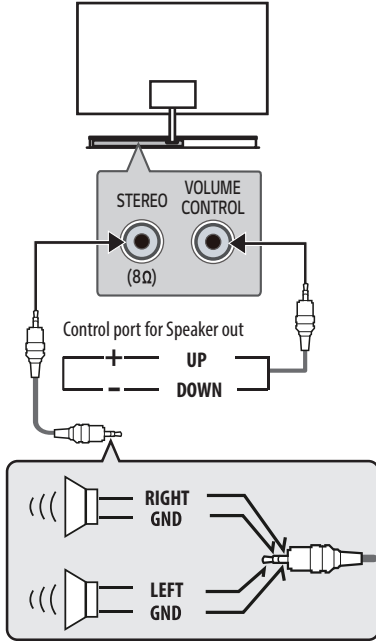

- ⚠ • Use only with the 3 Pole 3.5 mm Stereo Jack.
- Do not connect your headphones or earphones to the port for connecting an external speaker.

## Method of volume control port

- Cable Spec.

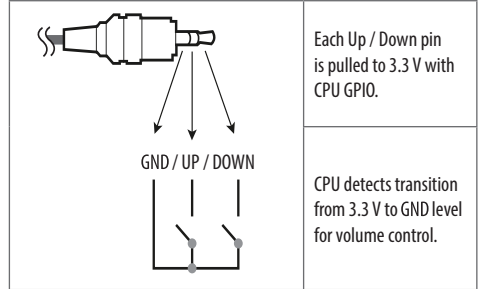

# Network

## Wired network connection

This TV can be connected to a Pro:Centric server via the **LAN** port. After making the physical connection, the TV needs to be set up for network communication.

Connect the **LAN** port of the Modem or Router from Pro:Centric server to the **LAN** port on the TV.

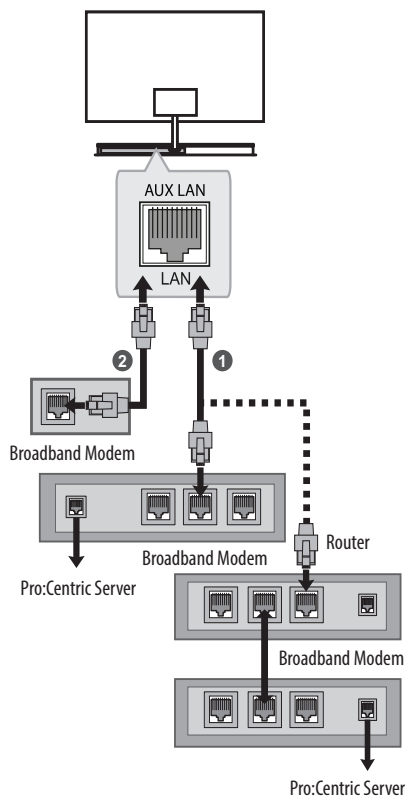

- 1 Connect the **LAN** port of the Modem or Router to the **LAN** port on the TV.
- 2 Connect the **LAN** port of the PC to the **AUX LAN** port on the TV.



- Do not connect a modular phone cable to the **LAN** port.
- Since there are various connection methods, please follow the specifications of your telecommunication carrier or internet service provider.

# Using Remote Control

The descriptions in this manual are based on the buttons on the remote control. Please read this manual carefully and use the TV correctly.

When the message "Magic Remote battery is low. Please change the battery." is displayed, replace the battery.

To replace batteries, open the battery cover, replace batteries (1.5 V AA) matching the ⊕ and ⊖ ends to the label inside the compartment, and close the battery cover. Be sure to point the magic remote toward the remote control sensor on the TV. To remove the batteries, perform the installation actions in reverse.

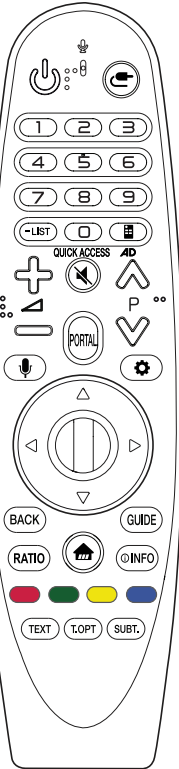

(Some buttons and services may not be provided depending on models or regions.)

\* To use the button, press and hold for more than 3 seconds.

**(POWER)** Turns the TV on or off.

**(INPUT)** Changes the input source.

**Number buttons** Enters numbers.

**LIST** Accesses the saved programme list.

**(Screen Remote)** Displays the Screen Remote.

- Accesses the Universal Control Menu.

**QUICK ACCESS\*** You can access apps or Live TV using the number buttons corresponding to the features.

**AD\*** Audio descriptions function will be enabled.

**+ -** Adjusts the volume level.

**(MUTE)** Mutes all sounds.

**\* (MUTE)** Accesses the [Accessibility] menu.

**▲ P ▼** Scrolls through the saved programmes.

**PORTAL** Displays and removes hotel interactive menu.

**(Voice recognition)**

Network connection is required to use the voice recognition function.

Once the voice display bar is activated on the TV screen, press and hold the button and speak your command out loud.

**(Q. Settings)** Accesses the Quick Settings.

**\* (Q. Settings)** Displays the [All Settings] menu.

**(Wheel (OK))** Press the center of the Wheel button to select a menu. You can change programmes by using the wheel button.

**△▽◀▶ (up/down/left/right)** Press the up, down, left or right button to scroll the menu. If you press △▽◀▶ buttons while the pointer is in use, the pointer will disappear from the screen and Magic Remote will operate like a general remote control. To display the pointer on the screen again, shake Magic Remote to the left and right.

**BACK** Returns to the previous level.

**BACK\*** Clears on-screen displays and returns to last input viewing.

**GUIDE** Shows programme guide.

**RATIO** Resizes an image.

**(HOME)** Accesses the Home menu.

**(HOME)** Shows the previous history.

**(INFO)** Views the information of the current programme and screen.

**Red, Green, Yellow, Blue** These access special functions in some menus.

**Teletext buttons (TEXT, T.OPT)** These buttons are used for teletext.

**SUBT.** Recalls your preferred subtitle in digital mode.

## Registering Magic Remote Control

### How to register the Magic Remote Control

To use the Magic Remote, first pair it with your TV.

- 1 Put batteries into the Magic Remote and turn the TV on.
- 2 Point the Magic Remote at your TV and press the  **Wheel (OK)** on the remote control.

\* If the TV fails to register the Magic Remote, try again after turning the TV off and back on.

### How to deregister the Magic Remote Control

Press the **BACK** and  (**HOME**) buttons at the same time, for five seconds, to unpair the Magic Remote with your TV.

\* Pressing and holding the **GUIDE** button will let you cancel and re-register Magic Remote at once.





- It is recommended that an Access Point (AP) be located more than 0.2 m away from the TV. If the AP is installed closer than 0.2 m, the Magic remote control may not perform as expected due to frequency interference.
- Do not mix new batteries with old batteries. This may cause the batteries to overheat and leak.
- Failure to match the correct polarities of the battery may cause the battery to burst or leak, resulting in fire, personal injury, or ambient pollution.
- This apparatus uses batteries. In your community there might be regulations that require you to dispose of these batteries properly due to environmental considerations. Please contact your local authorities for disposal or recycling information.
- The product's internal and external batteries should not be exposed to excessive heat such as direct sunlight, fire, or the like.

## Troubleshooting

The software version can be updated for improvement in performance.

Customer needs to ensure the compatibility of customer's equipment with LGE software. If needed, please consult with LGE and upload revised software version according to the guidance provided by LGE.

Cannot control the TV with the remote control.

- Check the remote control sensor on the product and try again.
- Check if there is any obstacle between the product and the remote control.
- Check if the batteries are still working and properly installed ( to  to ).

No image display and no sound is produced.

- Check if the product is turned on.
- Check if the power cord is connected to a wall outlet.
- Check if there is a problem in the wall outlet by connecting other products.

The TV turns off suddenly.

- Check the power control settings. The power supply may be interrupted.
- Check if the auto-off function is activated on the settings related time.
- If there is no signal while the TV is on, the TV will turn off automatically after 15 minutes of inactivity.

When connecting to the PC (HDMI), no signal is detected.

- Turn the TV off/on using the remote control.
- Reconnect the HDMI cable.
- Restart the PC with the TV on.

### Abnormal display

- If the product feels cold to the touch, there may be a small “flicker” when it is turned on. This is normal, there is nothing wrong with product.
- This panel is an advanced product that contains millions of pixels. You may see tiny black dots and/or brightly coloured dots (red, blue or green) at a size of 1 ppm on the panel. This does not indicate a malfunction and does not affect the performance and reliability of the product. This phenomenon also occurs in third-party products and is not subject to exchange or refund.
- You may find different brightness and colour of the panel depending on your viewing position(left/right/top/down). This phenomenon occurs due to the characteristic of the panel. It is not related with the product performance, and it is not malfunction.

### Generated sound

- “Cracking” noise: A cracking noise that occurs when watching or turning off the TV is generated by plastic thermal contraction due to temperature and humidity. This noise is common for products where thermal deformation is required.
- Electrical circuit humming/panel buzzing: A low level noise is generated from a high-speed switching circuit, which supplies a large amount of current to operate a product. It varies depending on the product. This generated sound does not affect the performance and reliability of the product.



- Make sure to wring any excess water or cleaner from the cloth.
- Do not spray water or cleaner directly onto the TV screen.
- Make sure to spray just enough of water or cleaner onto a dry cloth to wipe the screen.
- To clean the top of the Companion Box (AV box), spray a soft cloth with water. Then, wipe the surface so that the product does not come in direct contact with water. Next, wipe it again so that no moisture remains.
- Make sure to spray just enough of water or cleaner onto a dry cloth to wipe the screen.

# Specifications

(Depending on country)

| Broadcasting Specifications                      |  |              |  |                                  |
|--|--|--------------|--|----------------------------------|
|  | Digital TV   |              |  | Analogue TV                      |
| <b>Television system</b>                         | DVB-T<br>DVB-T2 <sup>1</sup><br>DVB-C<br>DVB-S/S2 <sup>1</sup> |              |  | PAL/SECAM B/G, D/K, I<br>SECAM L |
| <b>Channel coverage<br/>(Band)</b>               | DVB-S/S2 <sup>2</sup>  | DVB-C        | DVB-T/T2 <sup>2</sup>  | 46 ~ 862 MHz                     |
|  | 950 ~ 2,150 MHz  | 46 ~ 890 MHz | VHF III: 174 ~ 230 MHz<br>UHF IV: 470 ~ 606 MHz<br>UHF V: 606 ~ 862 MHz<br>S Band II: 230 ~ 300 MHz<br>S Band III: 300 ~ 470 MHz |                                  |
| <b>Maximum number of<br/>storable programmes</b> | 6,000  | 3,000        |  |                                  |
| <b>External antenna<br/>impedance</b>            | 75 Ω   |              |  |                                  |
| <b>CI Module (W x H x D)</b>                     | 100.0 mm x 55.0 mm x 5.0 mm                                    |              |  |                                  |

<sup>1</sup> Depending on country

<sup>2</sup> Only DVB-T2/C/S2 support model only.

**Wireless module (LGSBWAC72) specifications**

## Wireless LAN (IEEE 802.11a/b/g/n/ac)

| Frequency Range                 | Output Power (Max.) |
|---------------------------------|---------------------|
| 2,400 to 2,483.5 MHz            | 14 dBm              |
| 5,150 to 5,725 MHz              | 16.5 dBm            |
| 5,725 to 5,850 MHz (Not for EU) | 11.5 dBm            |

## Bluetooth

| Frequency Range      | Output Power (Max.) |
|----------------------|---------------------|
| 2,400 to 2,483.5 MHz | 8.5 dBm             |

As band channels can vary per country, the user cannot change or adjust the operating frequency. This product is configured for the regional frequency table.

For consideration of the user, this device should be installed and operated with a minimum distance of 20 cm between the device and the body. "IEEE 802.11ac" is not available in all countries.

**Environment condition**

|                              |                 |
|------------------------------|-----------------|
| <b>Operating Temperature</b> | 0 °C to 40 °C   |
| <b>Operating Humidity</b>    | Less than 80 %  |
| <b>Storage Temperature</b>   | -20 °C to 60 °C |
| <b>Storage Humidity</b>      | Less than 85 %  |



## HDMI-DTV supported mode

| Resolution   | Horizontal Frequency (kHz) | Vertical Frequency (Hz) |
|--------------|----------------------------|-------------------------|
| 640 x 480p   | 31.46                      | 59.94                   |
|              | 31.5                       | 60                      |
| 720 x 480p   | 31.47                      | 59.94                   |
|              | 31.5                       | 60                      |
| 720 x 576p   | 31.25                      | 50                      |
| 1280 x 720p  | 44.96                      | 59.94                   |
|              | 45                         | 60                      |
|              | 37.5                       | 50                      |
| 1920 x 1080i | 28.12                      | 50                      |
|              | 33.72                      | 59.94                   |
|              | 33.75                      | 60                      |
| 1920 x 1080p | 26.97                      | 23.97                   |
|              | 27                         | 24                      |
|              | 33.71                      | 29.97                   |
|              | 33.75                      | 30                      |
|              | 56.25                      | 50                      |
|              | 67.43                      | 59.94                   |
|              | 67.5                       | 60                      |
|              | 112.5                      | 100                     |
|              | 134.86                     | 119.88                  |
| 135          | 120                        |                         |
| 3840 x 2160p | 53.95                      | 23.98                   |
|              | 54                         | 24                      |
|              | 56.25                      | 25                      |
|              | 61.43                      | 29.97                   |
|              | 67.5                       | 30                      |
|              | 112.5                      | 50                      |
| 4096 x 2160p | 53.95                      | 23.98                   |
|              | 54                         | 24                      |
|              | 56.25                      | 25                      |
|              | 61.43                      | 29.97                   |
|              | 67.5                       | 30                      |
|              | 112.5                      | 50                      |
| 4096 x 2160p | 134.86                     | 59.94                   |
|              | 135                        | 60                      |

## HDMI-PC supported Mode

- PC audio is not supported.
- Use HDMI IN 1 for PC mode. (Depending on model)

| Resolution  | Horizontal Frequency (kHz) | Vertical Frequency (Hz) |
|-------------|----------------------------|-------------------------|
| 640 x 350   | 31.46                      | 70.09                   |
| 720 x 400   | 31.46                      | 70.08                   |
| 640 x 480   | 31.46                      | 59.94                   |
| 800 x 600   | 37.87                      | 60.31                   |
| 1024 x 768  | 48.36                      | 60                      |
| 1360 x 768  | 47.71                      | 60.01                   |
| 1152 x 864  | 54.34                      | 60.05                   |
| 1280 x 1024 | 63.98                      | 60.02                   |
| 1920 x 1080 | 67.5                       | 60                      |
|             | 134.86                     | 119.88                  |
|             | 135                        | 120                     |
| 3840 x 2160 | 53.95                      | 23.98                   |
|             | 54                         | 24                      |
|             | 56.25                      | 25                      |
|             | 61.43                      | 29.97                   |
|             | 67.5                       | 30                      |
|             | 112.5                      | 50                      |
| 4096 x 2160 | 134.86                     | 59.94                   |
|             | 135                        | 60                      |
|             | 53.95                      | 23.98                   |
|             | 54                         | 24                      |
|             | 56.25                      | 25                      |
|             | 61.43                      | 29.97                   |
| 4096 x 2160 | 67.5                       | 30                      |
|             | 112.5                      | 50                      |
|             | 134.86                     | 59.94                   |
|             | 135                        | 60                      |

## Supported Photo Formats

| File Format       | Format | Resolution   |
|-------------------|--------|--|
| .jpeg, .jpg, .jpe | JPEG   | Minimum: 64 (W) x 64 (H)<br>Maximum (Normal Type): 15360 (W) x 8640 (H)<br>Maximum (Progressive Type): 1920 (W) x 1440 (H) |
| .png              | PNG    | Minimum: 64 (W) x 64 (H)<br>Maximum: 5760 (W) x 5760 (H)   |
| .bmp              | BMP    | Minimum: 64 (W) x 64 (H)<br>Maximum: 1920 (W) x 1080 (H)   |

## Supported Audio Formats

| File Format | Item         | Info                |
|-------------|--------------|---------------------|
| .mp3        | Bit rate     | 32 Kbps - 320 Kbps  |
|             | Sample freq. | 16 kHz - 48 kHz     |
|             | Support      | MPEG1, MPEG2        |
|             | Channels     | mono, stereo        |
| .wav        | Bit rate     | -                   |
|             | Sample freq. | 8 kHz - 96 kHz      |
|             | Support      | PCM                 |
|             | Channels     | mono, stereo        |
| .ogg        | Bit rate     | 64 kbps - 320 kbps  |
|             | Sample freq. | 8 kHz - 48 kHz      |
|             | Support      | Vorbis              |
|             | Channels     | mono, stereo        |
| .wma        | Bit rate     | 128 kbps - 320 kbps |
|             | Sample freq. | 8 kHz - 48 kHz      |
|             | Support      | WMA                 |
|             | Channels     | up to 6 ch          |
| .flac       | Bit rate     | -                   |
|             | Sample freq. | 8 kHz - 96 kHz      |
|             | Support      | FLAC                |
|             | Channels     | mono, stereo        |

- The number of supported programmes may vary depending on the sample frequency.

## Supported Video Formats

| Extension | Codec |  |
|-----------|-------|--|
| .asf      | Video | VC-1 Advanced Profile (except for WMVA), VC-1 Simple and Main Profiles                       |
| .wmv      | Audio | WMA Standard (except for WMA v1/WMA Speech)  |
| .avi      | Video | Xvid (except for 3 warp-point GMC), H.264/AVC, Motion Jpeg, MPEG-4                           |
|           | Audio | MPEG-1 Layer I, II, MPEG-1 Layer III (MP3), Dolby Digital, LPCM, ADPCM, DTS                  |
| .mp4      | Video | H.264/AVC, MPEG-4, HEVC  |
| .m4v      | Audio | Dolby Digital, Dolby Digital Plus, AAC, MPEG-1 Layer III (MP3)                               |
| .mov      |       |  |
| .3gp      | Video | H.264/AVC, MPEG-4  |
| .3g2      | Audio | AAC, AMR-NB, AMR-WB  |
| .mkv      | Video | MPEG-2, MPEG-4, H.264/AVC, VP8, VP9, HEVC  |
|           | Audio | Dolby Digital, Dolby Digital Plus, AAC, PCM, DTS, MPEG-1 Layer I, II, MPEG-1 Layer III (MP3) |
| .ts       | Video | H.264/AVC, MPEG-2, HEVC  |
| .trp      | Audio | MPEG-1 Layer I, II, MPEG-1 Layer III (MP3), Dolby Digital, Dolby Digital Plus, AAC, PCM      |
| .tp       |       |  |
| .mts      |       |  |
| .mpg      | Video | MPEG-1, MPEG-2   |
| .mpeg     | Audio | MPEG-1 Layer I, II, MPEG-1 Layer III (MP3)   |
| .dat      |       |  |
| .vob      | Video | MPEG-1, MPEG-2   |
|           | Audio | Dolby Digital, MPEG-1 Layer I, II, DVD-LPCM  |

## Cautions for Video Playback

- ULTRA HD Video: 3840 x 2160, 4096 x 2160
- Some HEVC encoded ULTRA HD videos other than the content officially provided by LG Electronics may not be played.
- Some codecs can be supported after a software upgrade.

| Extension | Codec |  |
|-----------|-------|--|
| .mkv      | Video | H.264/AVC, HEVC                        |
| .mp4      | Audio | Dolby Digital, Dolby Digital Plus, AAC |
| .ts       |       |  |

## Supported External Subtitles

| Subtitle          | Format   |
|-------------------|--|
| External Subtitle | *.smi, *.srt, *.sub (MicroDVD, SubViewer 1.0/2.0), *.ass, *.ssa, *.txt (TMPlayer), *.psb (PowerDivX), *.dcs (DLP Cinema) |
| Embedded Subtitle | Matroska (mkv): Sub Station Alpha (SSA), Advanced Sub Station Alpha (ASS), SRT<br>MP4: Timed Text                        |

## Open Source Software Notice Information

To obtain the source code under GPL, LGPL, MPL, and other open source licenses, that is contained in this product, please visit <http://opensource.lge.com>.

In addition to the source code, all referred license terms, warranty disclaimers and copyright notices are available for download.

LG Electronics will also provide open source code to you on CD-ROM for a charge covering the cost of performing such distribution (such as the cost of media, shipping, and handling) upon email request to [opensource@lge.com](mailto:opensource@lge.com).

This offer is valid for a period of three years after our last shipment of this product. This offer is valid to anyone in receipt of this information.

## Licenses

Supported licenses may differ by model.



The terms HDMI and HDMI High-Definition Multimedia Interface, and the HDMI Logo are trademarks or registered trademarks of HDMI Licensing Administrator, Inc. in the United States and other countries.

For DTS patents, see <http://patents.dts.com>. Manufactured under license from DTS Licensing Limited. DTS, the Symbol, & DTS and the Symbol together, DTS 2.0 Channel, DTS 2.0+Digital Out, DTS-HD, and DTS Virtual:X are registered trademarks or trademarks of DTS, Inc. in the United States and/or other countries. © DTS, Inc. All Rights Reserved.

Manufactured under license from Dolby Laboratories. Dolby, Dolby Vision, Dolby Audio, Dolby Atmos, and the double-D symbol are trademarks of Dolby Laboratories.

(Depending on model)



POWERED BY

### QUICKSET

(Magic Remote supported models only)

**HEVC** Advance™  
Covered by Patents at [patentlist.hevcadvance.com](http://patentlist.hevcadvance.com)

## Important Information for Preventing Image Retention

OLED is a self-emissive technology, which brings many significant benefits to image quality and performance. As with any self-emitting display, it is possible for users of OLED TVs to experience temporary image retention under certain conditions, such as when displaying a static image on the screen for a long time. LG OLED TVs incorporate dedicated functions that protect the screen from possible image retention.

If a static image persists on screen, screen brightness is automatically reduced in specific areas of, or across the entire screen. Once the static image disappears, screen brightness will automatically return to its prior setting. This is not a product malfunction.



### Examples of Images that may Cause Image Retention

- Still images or fixed images containing certain information that are displayed uninterrupted on the screen, such as channel numbers, station logos, program titles, news or movie subtitles, and headlines.
- Fixed menu or icons for video game consoles or broadcasting set-top boxes.
- Black bars shown on the left, right, top, or bottom of the screen, such as in images with a 4:3 or 21:9 ratio.

## Recommended Measures for Preventing Image Retention

- Avoid watching a video displaying an image as listed above for extended periods of time.
- Adjust your TV settings as below when turning on a video exhibiting an image as listed above for extended periods of time.
  - [Picture] → [Picture Mode Settings] → [Picture Mode] → [Eco]
  - [Picture] → [Picture Mode Settings] → [OLED LIGHT] → Adjust to lower value
  - [Picture] → [OLED Panel Settings] → [Logo Luminance Adjustment] → [High]
- Turn off the menu bar of an external device, such as a set-top box, to prevent long-term display of the menu bar of such device. (Please refer to the manual of the applicable external device for instructions.)
- Adjust the settings as below when watching a video constantly showing black bars on the left, right, top or bottom, in order to remove the black bars.
  - [Picture] → [Aspect Ratio Settings] → [Aspect Ratio] → [Vertical Zoom] or [All-Direction Zoom]

## Information on Functions Supporting Image Quality in Relation to Temporary Image Retention

- LG OLED TVs provide a feature called Pixel Refresher, which helps to prevent temporary image retention.
- When the accumulated television viewing time reaches 2,000 hours or more (this is equivalent to watching TV for five hours a day over the course of a year), Pixel Refresher will be automatically activated once your TV is turned off. When turning off your TV, a notice will appear on the screen informing the activation of Pixel Refresher. This feature will run for an hour while your TV is turned off. A horizontal line may appear at the top or bottom of the screen when the process is almost finished.
- You may also manually activate Pixel Refresher via the TV menu:
  -  →  (gear) → [Picture] → [OLED Panel Settings] → [Pixel Refresher].
- Whenever you watch your TV for more than four cumulative hours, Pixel Refresher will be automatically activated for a few minutes once your TV is turned off. (Note: Pixel Refresher will not be activated if the power cord of your TV is not plugged in or the main power is off.)



The model and serial number of the product are located on the back and on one side of the product. Record them below in case you ever need service.

Model \_\_\_\_\_

Serial No. \_\_\_\_\_



# OWNER'S MANUAL

RS-232C



















# OLED TV

---





Please read this manual carefully before operating your set and retain it for future reference.

# IR CODES

- This feature is not available for all models.

| Code (Hexa) | Function  | Note                                    |
|-------------|---|---|
| 08          |  (POWER)   | Remote control Button<br>(Power On/Off) |
| 0B          |  (INPUT)   | Remote control Button                   |
| 11-19       | <b>Number Key 1-9</b>   | Remote control Button                   |
| 4C          | <b>- LIST</b>   | Remote control Button                   |
| DE          |  (Screen Remote)<br><b>AD</b><br> (Voice recognition) | Remote control Button                   |
| 10          | <b>Number Key 0</b><br><b>QUICK ACCESS</b>  | Remote control Button                   |
| 02          |    | Remote control Button                   |
| 03          |    | Remote control Button                   |
| 09          |  (MUTE)  | Remote control Button                   |
| 00          |  P<br> Wheel (UP)                                     | Remote control Button                   |
| 01          | P <br> Wheel (DOWN)                                   | Remote control Button                   |
| 0C          | <b>PORTAL</b>   | Remote control Button                   |
| 43          |  (Q. Settings)   | Remote control Button                   |
| 83          |  Wheel (OK)  | Remote control Button                   |
| 40          |    | Remote control Button                   |
| 41          |    | Remote control Button                   |
| 07          |    | Remote control Button                   |
| 06          |    | Remote control Button                   |
| 28          | <b>BACK</b>   | Remote control Button                   |
| AB          | <b>GUIDE</b>  | Remote control Button                   |
| 79          | <b>RATIO</b>  | Remote control Button                   |
| 7C          |  (HOME)  | Remote control Button                   |



| Code (Hexa) | Function   | Note                  |
|-------------|--|-----------------------|
| AA          |  INFO     | Remote control Button |
| 72          |  (RED)    | Remote control Button |
| 71          |  (GREEN)  | Remote control Button |
| 63          |  (YELLOW) | Remote control Button |
| 61          |  (BLUE)   | Remote control Button |
| 20          | TEXT   | Remote control Button |
| 21          | T.OPT(T.Option)  | Remote control Button |
| 39          | SUBT.  | Remote control Button |

## EXTERNAL CONTROL DEVICE SETUP

### RS-232C Setup

- Image shown may differ from your TV.
- Connect the RS-232C (serial port) input jack to an external control device (such as a computer or an A/V control system) to control the product's functions externally.
- Connect the serial port of the control device to the RS-232C jack on the product back panel.
- RS-232C connection cables are not supplied with the product.

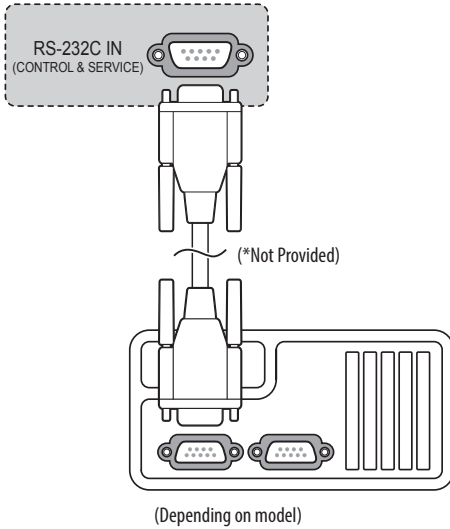

### Phone jack Type

(Depending on model)

- You need to purchase the phone-jack to RS-232C cable required for the connection between the PC and the TV, which is specified in the manual.
- For other models, connect to the USB port.
- The connection interface may differ from your TV.

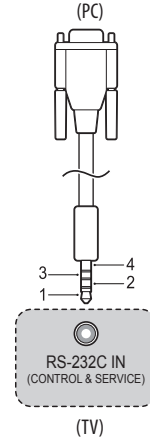

### Type of Connector : D-Sub 9-Pin Male

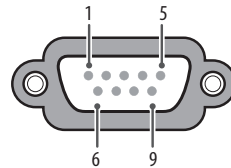

| No. | Pin name                                      |
|-----|---|
| 1   | 3.5 V   |
| 2   | RXD (Receive data)                            |
| 3   | TXD (Transmit data)                           |
| 4   | IR OUT from TV                                |
| 5   | GND   |
| 6   | No Connection                                 |
| 7   | No Connection (5 V available in some models)  |
| 8   | No Connection                                 |
| 9   | No Connection (12 V available in some models) |

## RS-232C Configurations

### 7-Wire Configurations (Standard RS-232C cable)

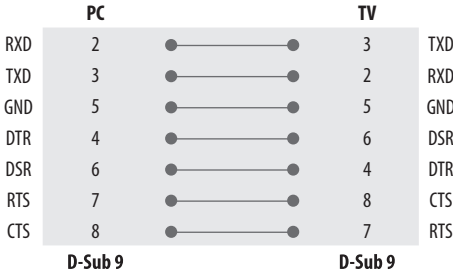

### 3-Wire Configurations (Not standard)

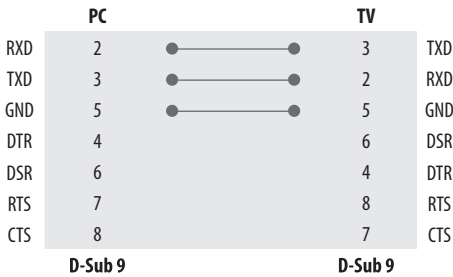

## Communication Parameters

- Baud rate: 9,600 bps (UART)
- Data length: 8 bits
- Parity: None
- Stop bit: 1 bit
- Communication code: ASCII code
- Use a crossed (reverse) cable.

## Command Reference List

(Depending on model)

|                                    | Command1 | Command2 | Data<br>(Hexadecimal) |
|------------------------------------|----------|----------|-----------------------|
| <b>1 Power</b>                     | k        | a        | 00 to 01              |
| <b>2 [Aspect Ratio]</b>            | k        | c        | (See p. 6)            |
| <b>3 Screen Mute</b>               | k        | d        | (See p. 7)            |
| <b>4 Volume Mute</b>               | k        | e        | 00 to 01              |
| <b>5 Volume Control</b>            | k        | f        | 00 to 64              |
| <b>6 [Contrast]</b>                | k        | g        | 00 to 64              |
| <b>7 [Brightness]</b>              | k        | h        | 00 to 64              |
| <b>8 [Colour]</b>                  | k        | i        | 00 to 64              |
| <b>9 [Tint]</b>                    | k        | j        | 00 to 64              |
| <b>10 [Sharpness]</b>              | k        | k        | 00 to 32              |
| <b>11 OSD Select</b>               | k        | l        | 00 to 01              |
| <b>12 Remote Control Lock Mode</b> | k        | m        | 00 to 01              |
| <b>13 [Balance]</b>                | k        | t        | 00 to 64              |
| <b>14 [Colour Temperature]</b>     | x        | u        | 00 to 64              |
| <b>15 [Energy Saving]</b>          | j        | q        | (See p. 9)            |
| <b>16 Auto Configuration</b>       | j        | u        | 01                    |
| <b>17 [Equalizer]</b>              | j        | v        | (See p. 9)            |
| <b>18 Tune Command</b>             | m        | a        | (See p. 10)           |
| <b>19 Programme [Skip] / [Add]</b> | m        | b        | 00 to 01              |
| <b>20 Key</b>                      | m        | c        | (See p. 10)           |
| <b>21 Control [Backlight]</b>      | m        | g        | 00 to 64              |
| <b>22 [Input] select</b>           | x        | b        | (See p. 11)           |

- During USB operations such as DivX or EMF, all commands except Power(ka) and Key(mc) are not executed and treated as NG.

## Transmission / Receiving Protocol

(Depending on Model)

### Transmission

#### (Command1)(Command2)([Set ID])([Data])(Cr)

(Command1) : First command to control the TV. (j, k, m or x)

(Command2) : Second command to control the TV.

([Set ID]) : You can adjust the set ID to choose desired monitor ID number in option menu. Adjustment range is 1 to 99. When selecting Set ID '0', every connected set is controlled. Set ID is indicated as decimal (1 to 99) on menu and as Hexa decimal (0 x 0 to 0 x 63) on transmission/receiving protocol.

([Data]) : To transmit command data. Transmit 'FF' data to read status of command.

(Cr) : Carriage Return

ASCII code '0 x 0D'

( ) : ASCII code 'space (0 x 20)'

### OK Acknowledgement

#### (Command2)([Set ID])(OK)([Data])(x)

\* The set transmits ACK (acknowledgement) based on this format when receiving normal data. At this time, if the data is data read mode, it indicates present status data. If the data is data write mode, it returns the data of the PC computer.

### Error Acknowledgement

#### (Command2)([Set ID])(NG)([Data])(x)

\* The set transmits ACK (acknowledgement) based on this format when receiving abnormal data from non-viable functions or communication errors.

[Data] 00 : Illegal Code

### 1 Power (Command: k a)

► To control Power On/Off of the set.

Transmission

(k)(a)([Set ID])([Data])(Cr)

[Data] 00 : [Off]

[Data] 01 : [On]

Ack

(a)([Set ID])(OK/NG)([Data])(x)

► To Show TV is Power On/Off.

Transmission

(k)(a)([Set ID])(FF)(Cr)

Ack

(a)([Set ID])(OK/NG)([Data])(x)

\* Similarly, if other functions transmit '0 x FF' data based on this format, Acknowledgement data feed back presents status about each function.

\* OK Ack., Error Ack. and other message may display on the screen when TV is power On.

### 2 [Aspect Ratio] (Command: k c) (Main Picture Size)

► To adjust the screen format. (Main picture format) You can also adjust the screen format using the picture settings.

Transmission

(k)(c)([Set ID])([Data])(Cr)

[Data] 01 : [4:3] (Normal screen - [Just Scan] Off)

[Data] 02 : [16:9] (Wide screen - [Just Scan] Off)

[Data] 06 : [Original] ([Just Scan] Off)

[Data] 09 : [Just Scan]

\* Please make sure that the model doesn't support both Vertical Zoom and All-Direction Zoom mode.

Ack

(c)([Set ID])(OK/NG)([Data])(x)

\* Using the PC input, you select either 16:9 or 4:3 screen aspect ratio.

**3 Screen Mute** (Command: k d)

- ▶ To select screen mute on/off.

Transmission

`(k)(d)( )([Set ID])( )([Data])(Cr)`

[Data] 00 : Screen mute off (Picture on) / Video mute off

[Data] 01 : Screen mute on (Picture off)

[Data] 10 : Video mute on

Ack

`(d)( )([Set ID])( )(OK/NG)([Data])(x)`

- \* In case of video mute on only, TV will display On Screen Display (OSD). But, in case of Screen mute on, TV will not display OSD.

**4 Volume Mute** (Command: k e)

- ▶ To control volume mute on/off.  
You can also adjust mute using the mute button on remote control.

Transmission

`(k)(e)( )([Set ID])( )([Data])(Cr)`

[Data] 00 : Volume mute on (Volume off)

[Data] 01 : Volume mute off (Volume on)

Ack

`(e)( )([Set ID])( )(OK/NG)([Data])(x)`**5 Volume Control** (Command: k f)

- ▶ To adjust volume.  
You can also adjust volume with the volume buttons on remote control.

Transmission

`(k)(f)( )([Set ID])( )([Data])(Cr)`

[Data] Min : 00 to Max : 64

- \* Refer to "Real data mapping".

Ack

`(f)( )([Set ID])( )(OK/NG)([Data])(x)`**6 [Contrast]** (Command: k g)

- ▶ To adjust screen contrast.  
You can also adjust contrast in the picture settings.

Transmission

`(k)(g)( )([Set ID])( )([Data])(Cr)`

Data Min : 00 to Max : 64

- \* Refer to "Real data mapping".

Ack

`(g)( )([Set ID])( )(OK/NG)([Data])(x)`**7 [Brightness]** (Command: k h)

- ▶ To adjust screen brightness.  
You can also adjust brightness in the picture settings.

Transmission

`(k)(h)( )([Set ID])( )([Data])(Cr)`

Data Min : 00 to Max : 64

- \* Refer to "Real data mapping".

Ack

`(h)( )([Set ID])( )(OK/NG)([Data])(x)`**8 [Colour]** (Command: k i)

- ▶ To adjust the screen colour.  
You can also adjust colour in the picture settings.

Transmission

`(k)(i)( )([Set ID])( )([Data])(Cr)`

[Data] Min : 00 to Max : 64

- \* Refer to "Real data mapping".

Ack

`(i)( )([Set ID])( )(OK/NG)([Data])(x)`

**9 [Tint]** (Command: k j)

- ▶ To adjust the screen tint.

You can also adjust tint in the picture settings.

Transmission

(k)(j)( )([Set ID])( )([Data])(Cr)

[Data] Red : 00 to Green : 64

- \* Refer to "Real data mapping".

Ack

(j)( )([Set ID])( ) (OK/NG)([Data])(x)

**10 [Sharpness]** (Command: k k)

- ▶ To adjust the screen sharpness.

You can also adjust sharpness in the picture settings.

Transmission

(k)(k)( )([Set ID])( )([Data])(Cr)

[Data] Min : 00 to Max : 32

- \* Refer to "Real data mapping".

Ack

(k)( )([Set ID])( ) (OK/NG)([Data])(x)

**11 OSD Select** (Command: k l)

- ▶ To select OSD (On Screen Display) on/off when controlling remotely.

Transmission

(k)(l)( )([Set ID])( )([Data])(Cr)

[Data] 00 : [Off]

[Data] 01 : [On]

Ack

(l)( )([Set ID])( ) (OK/NG)([Data])(x)

**12 Remote Control Lock Mode** (Command: k m)

- ▶ To lock the front panel controls on the monitor and remote control.

Transmission

(k)(m)( )([Set ID])( )([Data])(Cr)

[Data] 00 : [Off]

[Data] 01 : [On]

Ack

(m)( )([Set ID])( ) (OK/NG)([Data])(x)

- \* If you are not using the remote control, use this mode. When main power is on/off, external control lock is released.

- \* In the standby mode, if key lock is on, TV will not turn on by power on key of IR & Local Key.

**13 [Balance]** (Command: k t)

- ▶ To adjust balance.

You can also adjust balance in the audio settings.

Transmission

(k)(t)( )([Set ID])( )([Data])(Cr)

[Data] L : 00 to R : 64

- \* Refer to "Real data mapping".

Ack

(t)( )([Set ID])( ) (OK/NG)([Data])(x)

**14 [Colour Temperature]** (Command: x u)

- ▶ To adjust Colour Temperature. You can also adjust Colour Temperature in the picture settings.

Transmission

(x)(u)( )([Set ID])( )([Data])(Cr)

[Data] Warm: 00 to Cool:64

- \* Refer to "Real data mapping".

Ack

(u)( )([Set ID])( ) (OK/NG)([Data])(x)

**15 [Energy Saving]** (Command: j q)

- ▶ To reduce the power consumption of the TV. You can also adjust Energy Saving in picture settings.

Transmission

`(j)(q)( )([Set ID])( )([Data])(Cr)`

| Power Saving Function |   |   |   |           | Level |   |   |   | Description  |
|-----------------------|---|---|---|-----------|-------|---|---|---|--------------|
| 7                     | 6 | 5 | 4 |           | 3     | 2 | 1 | 0 |              |
| 0                     | 0 | 0 | 0 | Low Power | 0     | 0 | 0 | 0 | [Off]        |
| 0                     | 0 | 0 | 0 | Low Power | 0     | 0 | 0 | 1 | [Minimum]    |
| 0                     | 0 | 0 | 0 | Low Power | 0     | 0 | 1 | 0 | [Medium]     |
| 0                     | 0 | 0 | 0 | Low Power | 0     | 0 | 1 | 1 | [Maximum]    |
| 0                     | 0 | 0 | 0 | Low Power | 0     | 1 | 0 | 1 | [Screen Off] |
| 0                     | 0 | 0 | 0 | Low Power | 0     | 1 | 0 | 0 | [Auto]       |

- ▶ [Auto] is available in TV that supports 'Intelligent Sensor'.

Ack

`(q)( )([Set ID])( )(OK/NG)([Data])(x)`**16 Auto Configuration** (Command: j u) (Only RGB support model)

- ▶ To adjust picture position and minimize image shaking automatically. It works only in RGB (PC) mode.

Transmission

`(j)(u)( )([Set ID])( )([Data])(Cr)`

[Data] 01 : To set

Ack

`(u)( )([Set ID])( )(OK/NG)([Data])(x)`**17 [Equalizer]** (Command : j v)

- ▶ To adjust equalizer.

Transmission

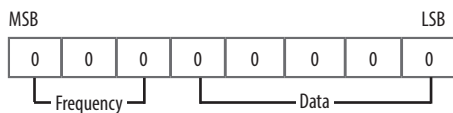
`(j)(v)( )([Set ID])( )([Data])(Cr)`

| 7 | 6 | 5 | Frequency | 4   | 3   | 2   | 1   | 0   | Step         |
|---|---|---|-----------|-----|-----|-----|-----|-----|--------------|
| 0 | 0 | 0 | 1st Band  | 0   | 0   | 0   | 0   | 0   | 0 (decimal)  |
| 0 | 0 | 1 | 2nd Band  | 0   | 0   | 0   | 0   | 1   | 1 (decimal)  |
| 0 | 1 | 0 | 3rd Band  | ... | ... | ... | ... | ... | ...          |
| 0 | 1 | 1 | 4th Band  | 1   | 0   | 0   | 1   | 1   | 19 (decimal) |
| 1 | 0 | 0 | 5th Band  | 1   | 0   | 1   | 0   | 0   | 20 (decimal) |

Ack

`(v)( )([Set ID])( )(OK/NG)([Data])(x)`

**18 Tune Command** (Command: m a)

- Select channel to following physical number.

Transmission

```
(m)(a)( )([Set ID])( )([Data] 00)( )([Data] 01)( )([Data] 02)(Cr)
```

[Data] 00 : High channel data

[Data] 01 : Low channel data

ex. No. 47 → 00 2F (2FH)

No. 394 → 01 8A (18AH),

DTV No. 0 → Don't care

[Data] 02 : (Antenna)

0 x 00 : Analogue Main

0 x 10 : DTV Main

0 x 20 : Radio

(Cable)

0 x 80 : Analogue Main

0 x 90 : DTV Main

0 x A0 : Radio

(Satellite)

0 x 40 : DTV Main

0 x 50 : Radio Main

Channel data range

Min : 00 Max : 270F (0 to 9999)

Ack

```
(a)( )([Set ID])( )([OK/NG])([Data])(x)
```

**19 Programme [Skip] / [Add]** (Command: m b)

- To set skip status for the current Programme.

Transmission

```
(m)(b)( )([Set ID])( )([Data])(Cr)
```

[Data] 00 : [Skip]

[Data] 01 : [Add]

Ack

```
(b)( )([Set ID])( )([OK/NG])([Data])(x)
```

**20 Key** (Command: m c)

- To send IR remote key code.

Transmission

```
(m)(c)( )([Set ID])( )([Data])(Cr)
```

[Data] IR CODES

Ack

```
(c)( )([Set ID])( )([OK/NG])([Data])(x)
```

**21 Control [Backlight]** (Command: m g)

- To control the backlight.

Transmission

```
(m)(g)( )([Set ID])( )([Data])(Cr)
```

[Data] Min : 00 to Max : 64

Ack

```
(g)( )([Set ID])( )([OK/NG])([Data])(x)
```



**22 [Input] select** (Command: x b) (Main Picture Input)

► To select input source for main picture.

Transmission

(x)(b)( )([Set ID])( )([Data])(Cr)

[Data] Structure

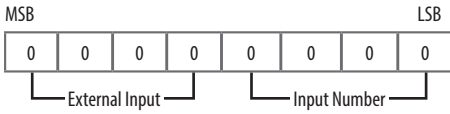

| External Input |   |   |   | Data      |
|----------------|---|---|---|-----------|
| 0              | 0 | 0 | 0 | DTV       |
| 0              | 0 | 0 | 1 | Analogue  |
| 0              | 0 | 1 | 0 | AV        |
| 0              | 1 | 0 | 0 | Component |
| 0              | 1 | 1 | 0 | RGB       |
| 0              | 1 | 1 | 1 | HDMI      |
| 1              | 0 | 0 | 0 |           |
| 1              | 0 | 0 | 1 |           |
| 1              | 0 | 1 | 0 |           |

| Input Number |   |   |   | Data   |
|--------------|---|---|---|--------|
| 0            | 0 | 0 | 0 | Input1 |
| 0            | 0 | 0 | 1 | Input2 |
| 0            | 0 | 1 | 0 | Input3 |
| 0            | 0 | 1 | 1 | Input4 |

Ack

(b)( )([Set ID])( )(OK/NG)([Data])(x)

| * Real data mapping |                       |
|---------------------|-----------------------|
| 00:                 | Step 0                |
| :                   |                       |
| A:                  | Step 10 ([Set ID] 10) |
| :                   |                       |
| F:                  | Step 15 ([Set ID] 15) |
| 10:                 | Step 16 ([Set ID] 16) |
| :                   |                       |
| 64:                 | Step 100              |
| :                   |                       |
| 6E:                 | Step 110              |
| :                   |                       |
| 73:                 | Step 115              |
| 74:                 | Step 116              |
| :                   |                       |
| CF:                 | Step 199              |
| :                   |                       |
| FE:                 | Step 254              |
| FF:                 | Step 255              |



The model and serial number of the product are located on the back and on one side of the product. Record them below in case you ever need service.

Model \_\_\_\_\_

Serial no. \_\_\_\_\_