

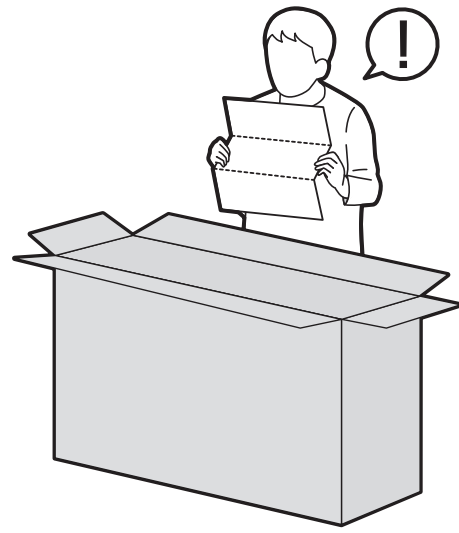

NANO79*

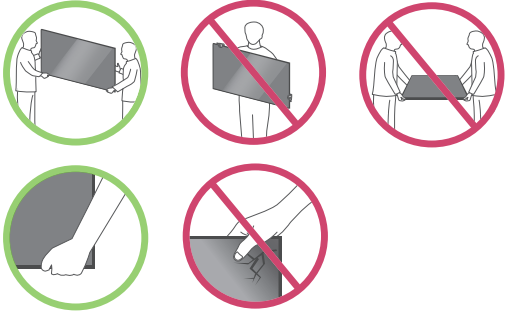

1
43/50/55NANO79*

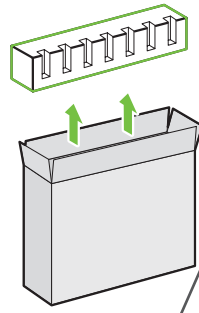

2

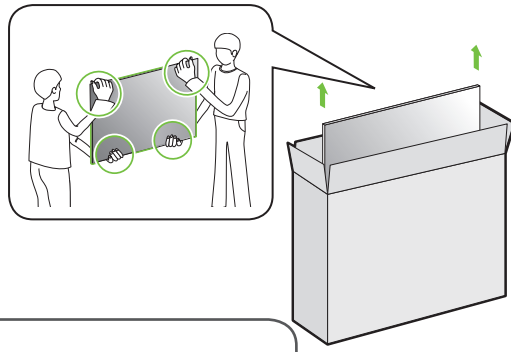

3

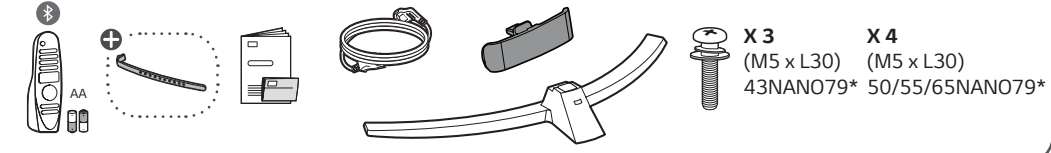
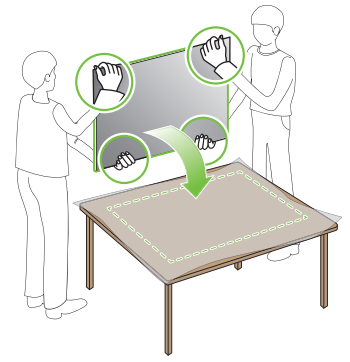

1

65NANO79*

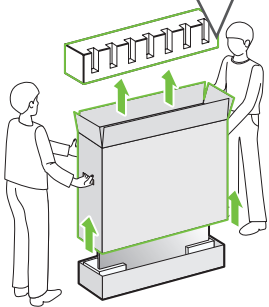

2

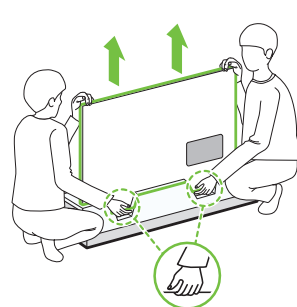

3

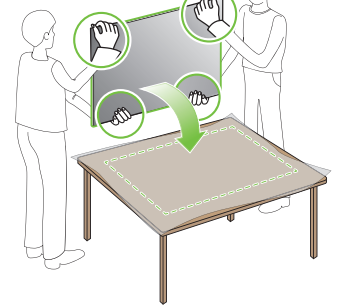

1

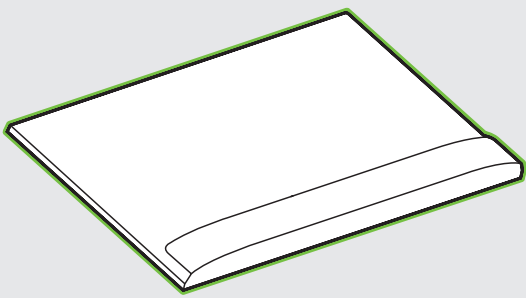

2

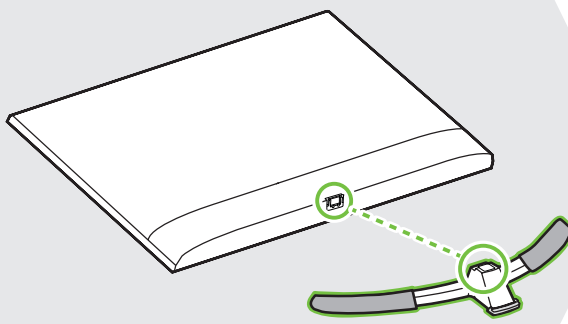

3

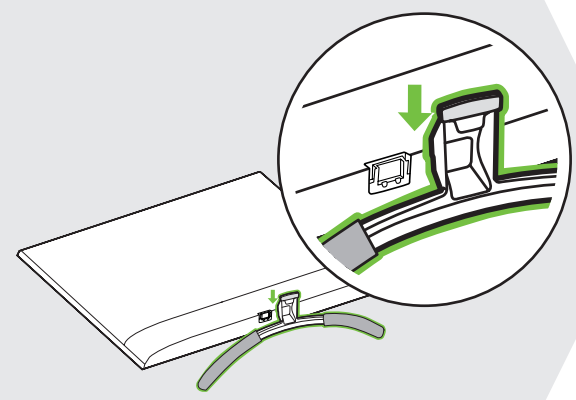

4-A 43NANO79*

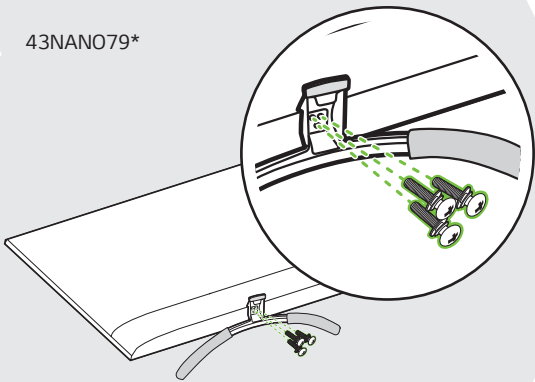

4-B 50/55/65NANO79*

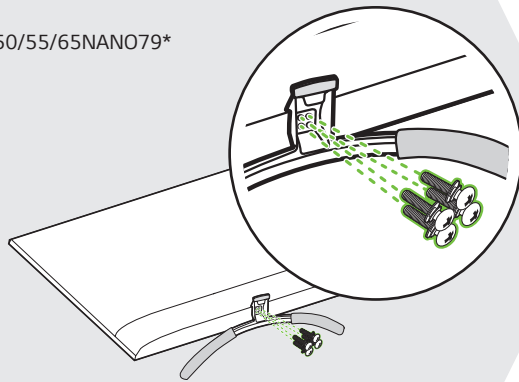

5

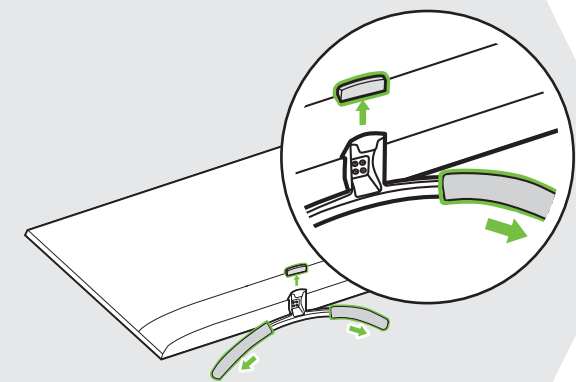

6

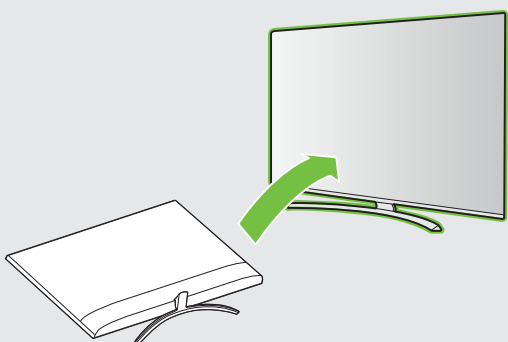

7

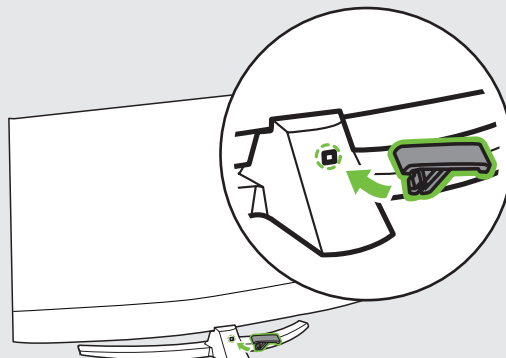

8



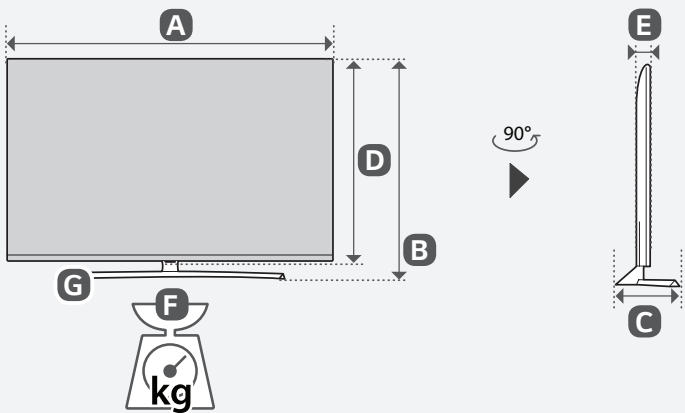
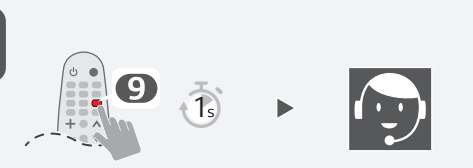
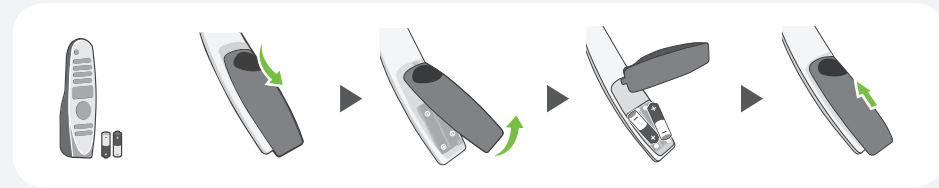
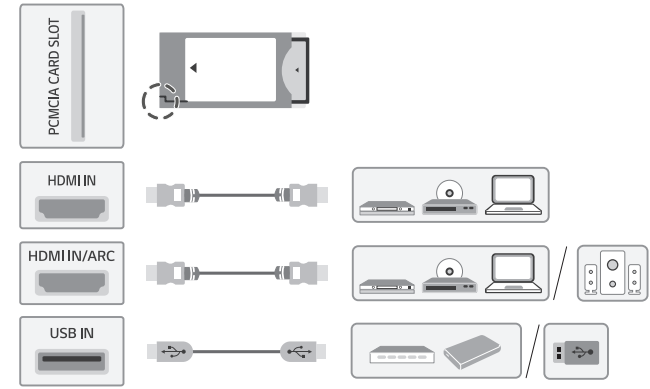
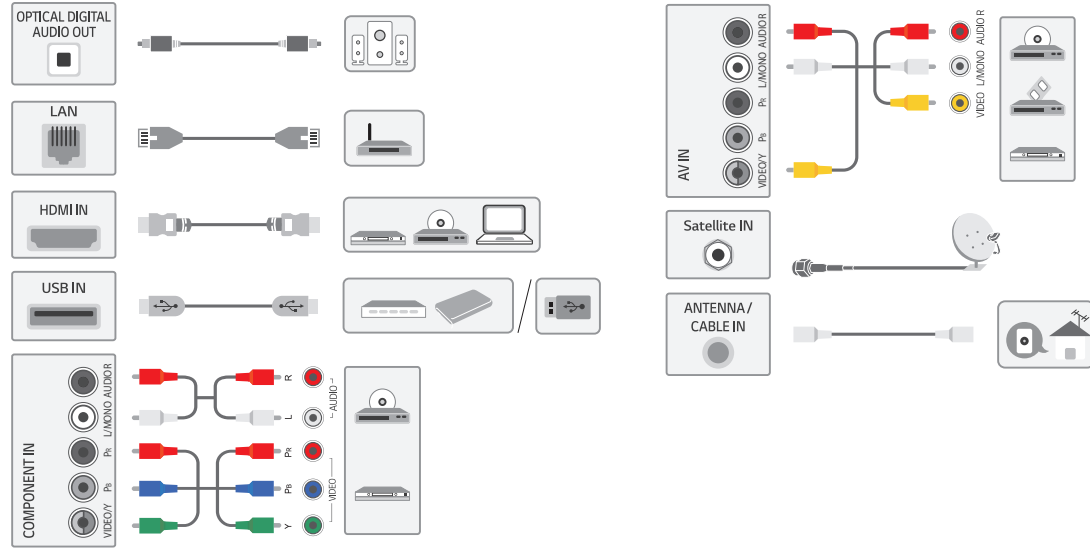

	A	B	C	D	E	F	F-G
	(mm)					(kg)	
43NANO796NE 43NANO796NF 43NANO793NE	973	622	221	572	85.0	9.0	8.2
50NANO796NE 50NANO796NF 50NANO793NE	1130	728	260	663	86.3	12.5	11.5
55NANO796NE 55NANO796NF 55NANO793NE	1244	791	260	726	87.1	15.6	14.6
65NANO796NE 65NANO796NF 65NANO793NE	1463	914	340	850	87.8	22.4	21.4
Power requirement				AC 100-240 V ~ 50 / 60 Hz			



English · Read Safety and Regulatory.

Deutsch · Lesen Sie die Sicherheitsanweisungen und Richtlinien.

Français · Lire le document Sécurité et mesures réglementaires.

Italiano · Leggere il manuale Sicurezza e normative.

Español · Leer Seguridad y normativa.

Português · Ler informações sobre a Segurança e Regulamentos.

Nederlands · Veiligheidsinformatie en regelgeving lezen.

Ελληνικά · Διαβάστε τις οδηγίες για την ασφάλεια και τους κανονισμούς.

Slovenščina · Preberite varnostne in regulativne vidike.

Hrvatski · Pročitajte Sigurnost i uskladenost s propisima.

Shqip · Lexoni paragrafin "Siguria dhe rregullimi".

Bosanski · Pročitajte dio Sigurnost i propisi.

Македонски · Прочитajte за безбедноста и регулативата.

Svenska · Läs Säkerhet och föreskrifter.

Magyar · Biztonsági szabályzat megtekintése.

Polski · Prosimy o przeczytanie Zasad bezpieczeństwa i uwag dotyczących przepisów.

Česky · Přečtěte si část Bezpečnost a zákonné předpisy.

Slovenčina · Prečitajte si bezpečnostné a regulačné informácie.

Română · Consultați manualul referitor la siguranță și reglementare.

Български · Прочетете Безопасност и регулаторни стандарти.

Eesti · Lugege ohutus- ja normatiivteavet.

Lietuvių k. · Perskaitykite Saugos ir norminius reikalavimus.

Latviešu · Izlasiet sadaļu Drošība un normatīvi.

Srpski · Pročitajte odeljak Bezbednost i regulatorna pitanja.

Norsk · Les sikkerhet og forskrifter.

Dansk · Læs sikkerhed og lovmæssige bestemmelser.

Suomi · Lue Turvallisuus ja säännökset -osio.

⊕ : Depending on model / Abhängig vom Modell / Selon le modèle / In base al modello / En función del modelo / Dependendo do modelo / Afhankelijk van het model / Αν λογα με το μοντ λο / Odvisno od modela / Típusfüggő / Zależnie od modelu / Závísí na modelu / V závislosti od modelu / In functie de model / в зависимости от модели / Sõltub mudelist / Priklauso nuo modelio / Atkarībā no modeļa / U zavisnosti od modela / Ovisno o modelu / Në varësi të modelit / Ovisno o modelu / во зависност од моделот / Beroende på modell / Avhengig av modell / Afhængigt af modellen / Mallin mukaan