

UN81*

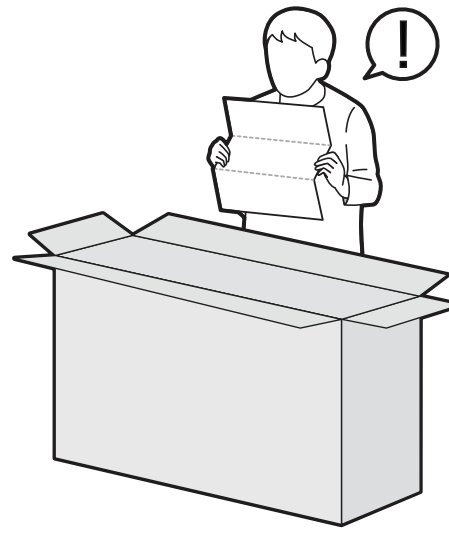

1
55UN81*

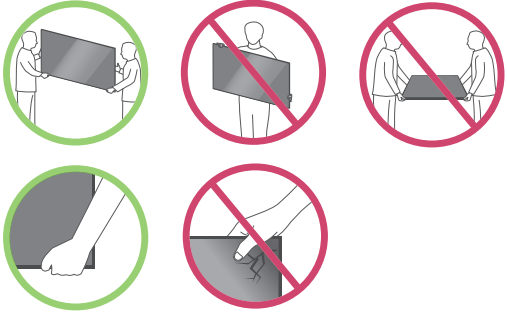
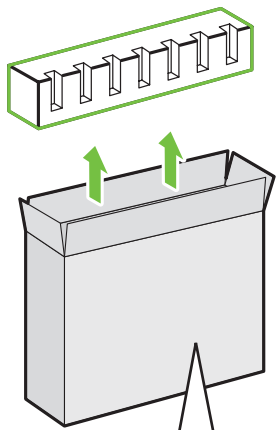

2

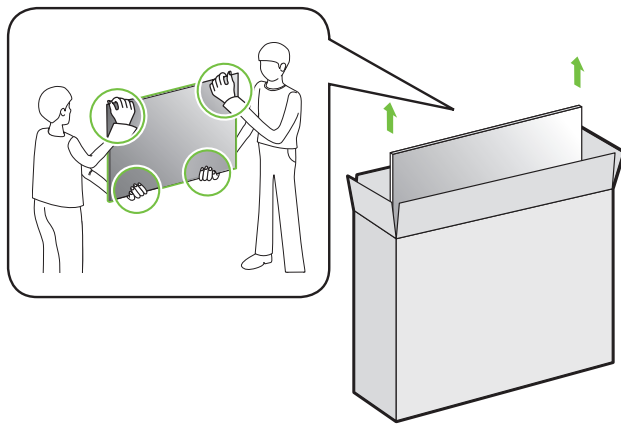

3

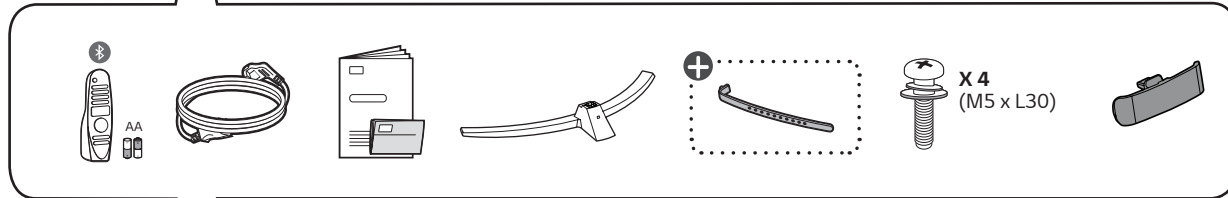
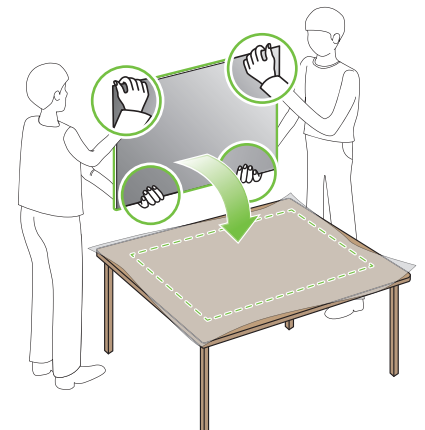

1
65UN81*

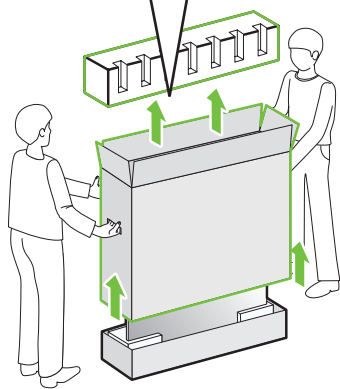

2

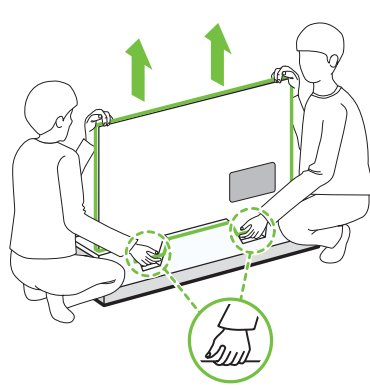

3

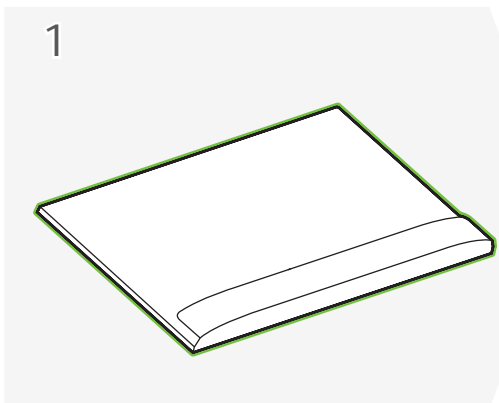
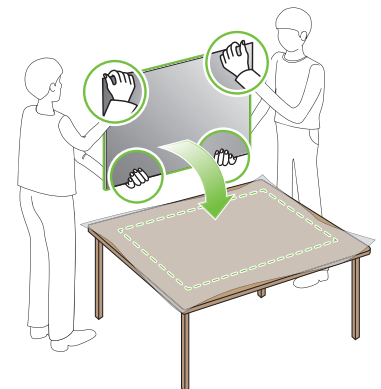

2

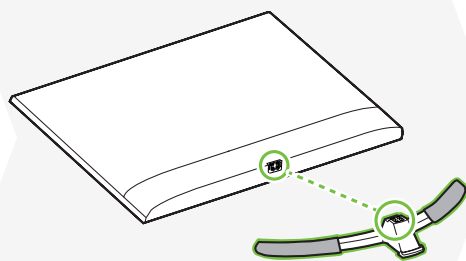

3

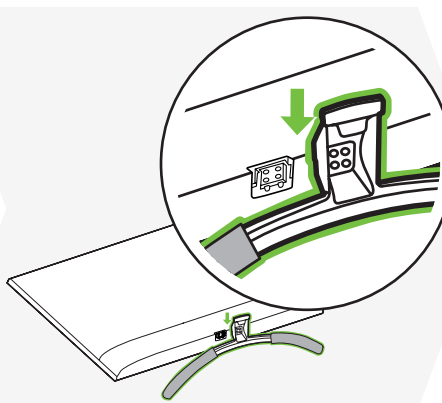

4

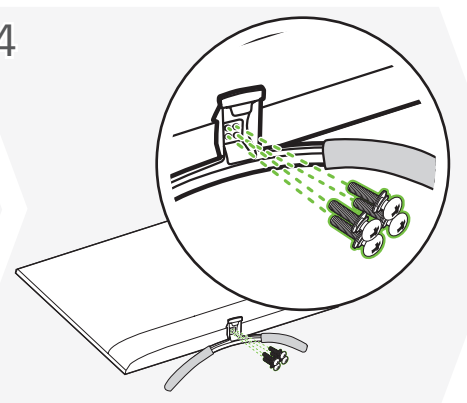

5

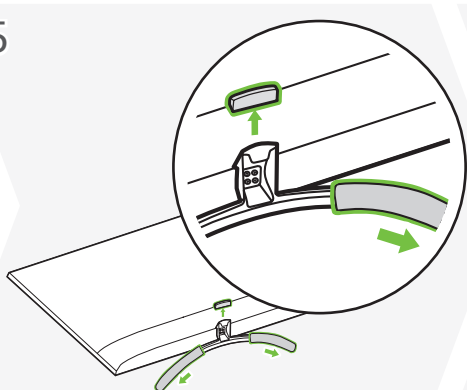

6

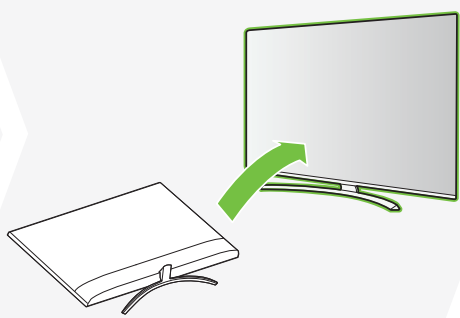

7

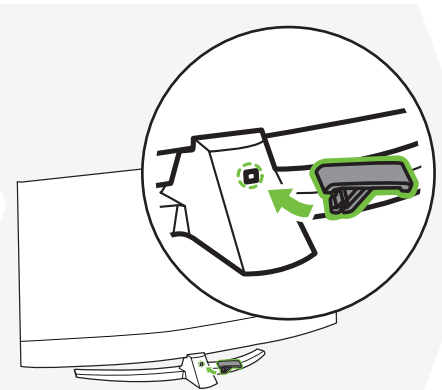

8

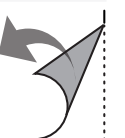
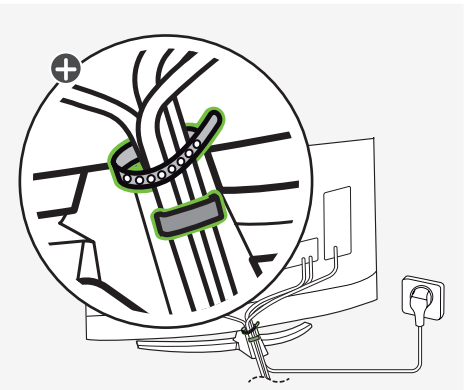

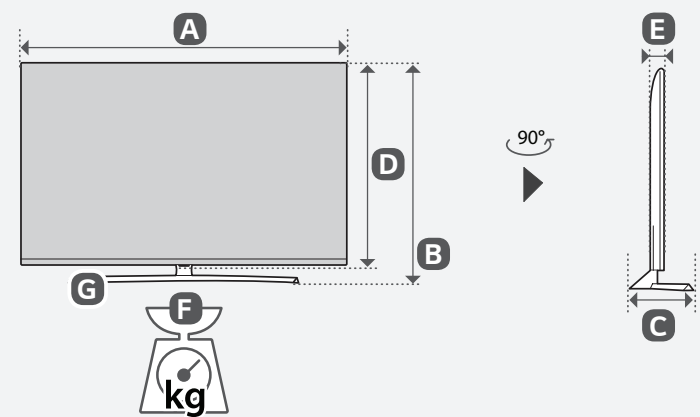
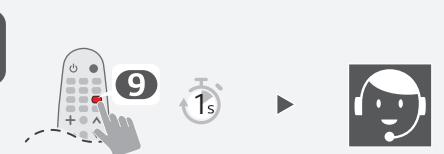
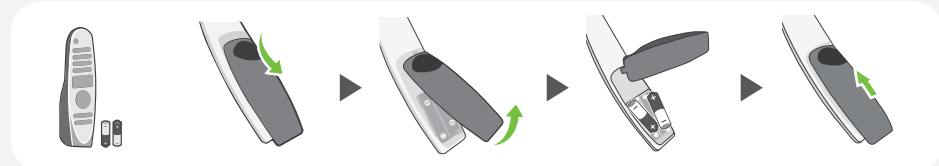
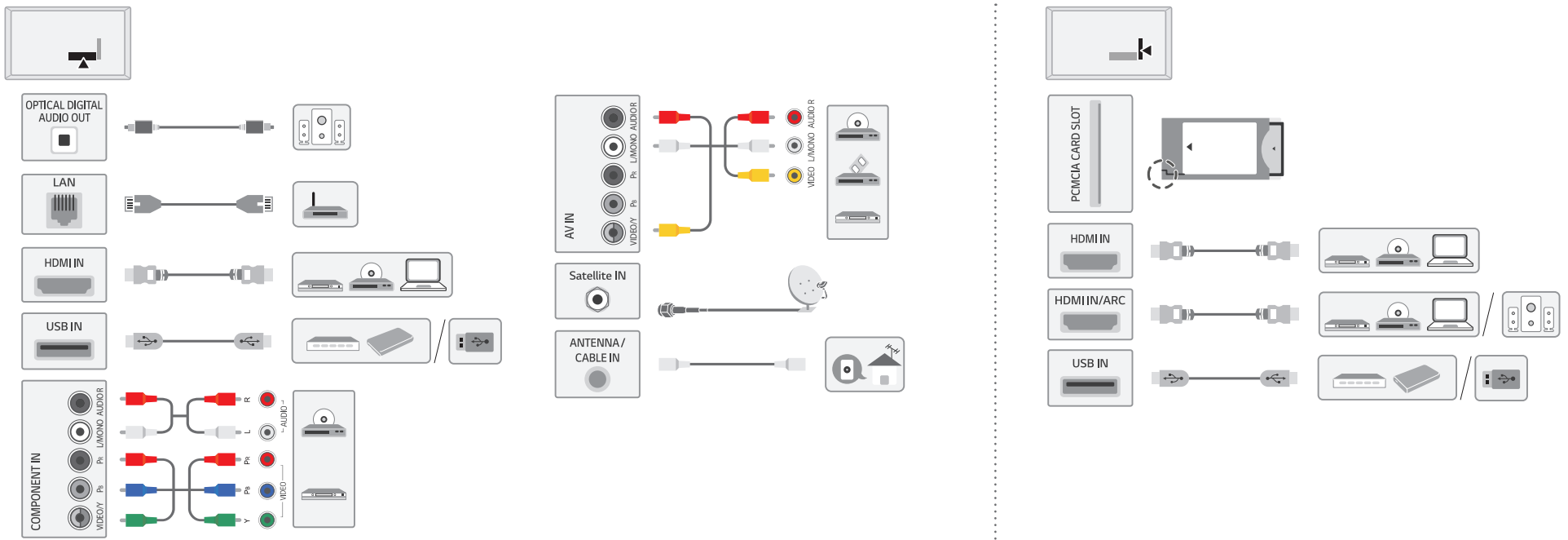

	A	B	C	D	E	F	F-G
	(mm)				(kg)		
55UN81006LB 55UN81003LB	1234	784	260	717	84.0	17.1	16.1
65UN81006LB 65UN81003LB	1453	907	340	840	84.0	24.1	23.0
Power requirement				AC 100-240 V ~ 50 / 60 Hz			



English · Read Safety and Regulatory.

Deutsch · Lesen Sie die **Sicherheitsanweisungen und Richtlinien**.

Français · Lire le document **Sécurité et mesures réglementaires**.

Italiano · Leggere il manuale **Sicurezza e normativa**.

Español · Leer **Seguridad y normativa**.

Português · Ler informações sobre a **Segurança e Regulamentos**.

Nederlands · **Veiligheidsinformatie en regelgeving** lezen.

Ελληνικά · Διαβάστε τις **οδηγίες για την ασφάλεια και τους κανονισμούς**.

Slovenščina · Preberite **varnostne in regulativne vidike**.

Hrvatski · Pročitajte **Sigurnost i usklađenost s propisima**.

Shqip · Lexoni paragrafin "**Siguria dhe rregullimi**".

Bosanski · Pročitajte dio **Sigurnost i propisi**.

Македонски · Прочитajte за **безбедноста и регулативата**.

Svenska · Läs **Säkerhet och föreskrifter**.

Magyar · Biztonsági szabályzat megtekintése.

Polski · Prosimy o przeczytanie **Zasad bezpieczeństwa i uwag dotyczących przepisów**.

Česky · Přečtěte si část **Bezpečnost a zákonné předpisy**.

Slovenčina · Prečitajte si **bezpečnostné a regulačné informácie**.

Română · Consultați manualul referitor la **siguranță și reglementare**.

Български · Прочетете **Безопасност и регулаторни стандарти**.

Eesti · Lugege **ohutus- ja normatiivteavet**.

Lietuvių k. · Perskaitykite **Saugos ir norminius reikalavimus**.

Latviešu · Izlasiet sadaļu **Drošība un normatīvi**.

Srpski · Pročitajte odeljak **Bezbednost i regulatorna pitanja**.

Norsk · Les **sikkerhet og forskrifter**.

Dansk · Læs **sikkerhed og lovmæssige bestemmelser**.

Suomi · Lue **Turvallisuus ja säännökset** -osio.

+ : Depending on model / Abhängig vom Modell / Selon le modèle / In base al modello / En función del modelo / Dependendo do modelo / Afhankelijk van het model / Αν λογα με το μοντ λο / Odvisno od modela / Tipusfüggő / Zależnie od modelu / Závísí na modelu / V závislosti od modelu / În funcție de model / В зависимости от модели / Sõltub mudelist / Priklauso nuo modelio / Atkarībā no modeļa / U zavisnosti od modela / Ovisno o modelu / Në varësi të modelit / Ovisno o modelu / во зависност од моделот / Beroende på modell / Afhengigt af modellen / Mallin mukaan