

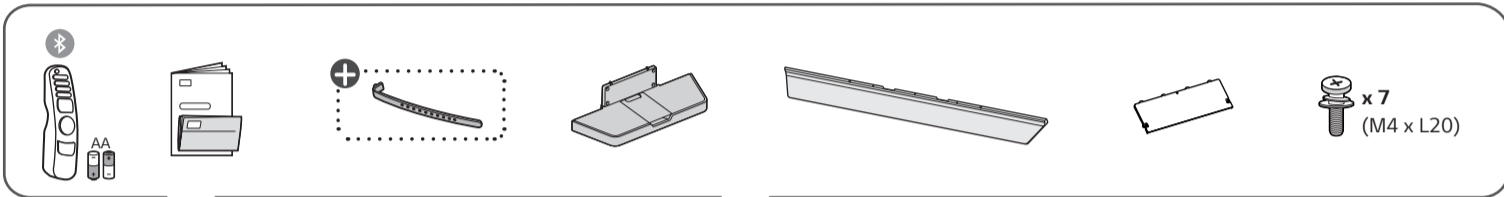

OLED55C1\*  
OLED65C1\*  
OLED77C1\*

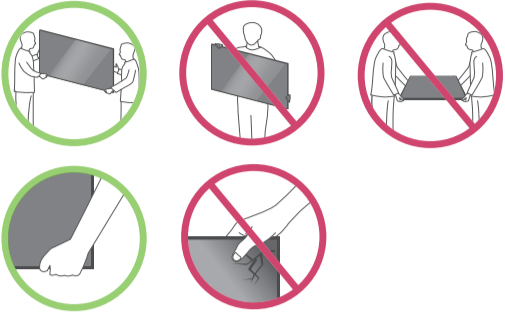

1-A OLED55/65C1\*

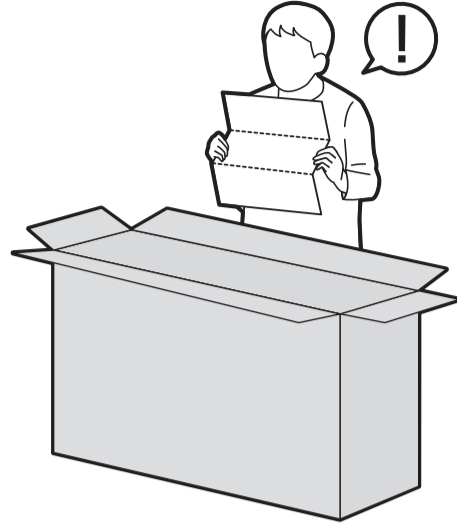
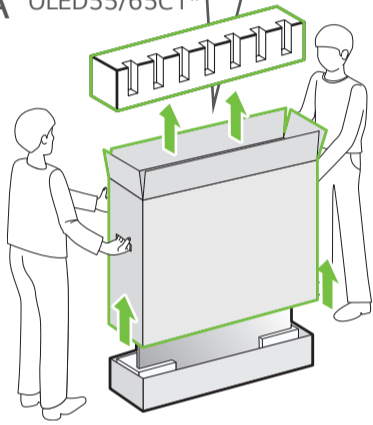

1-B OLED77C1\*

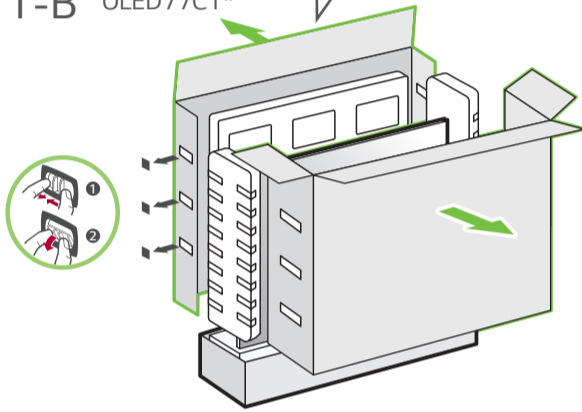

2

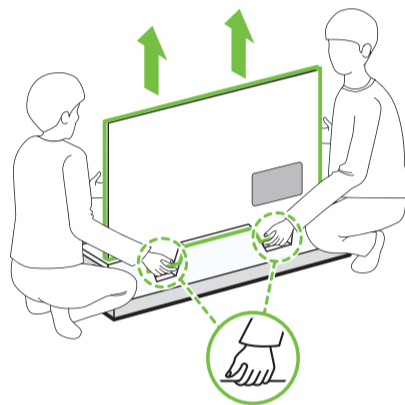

3

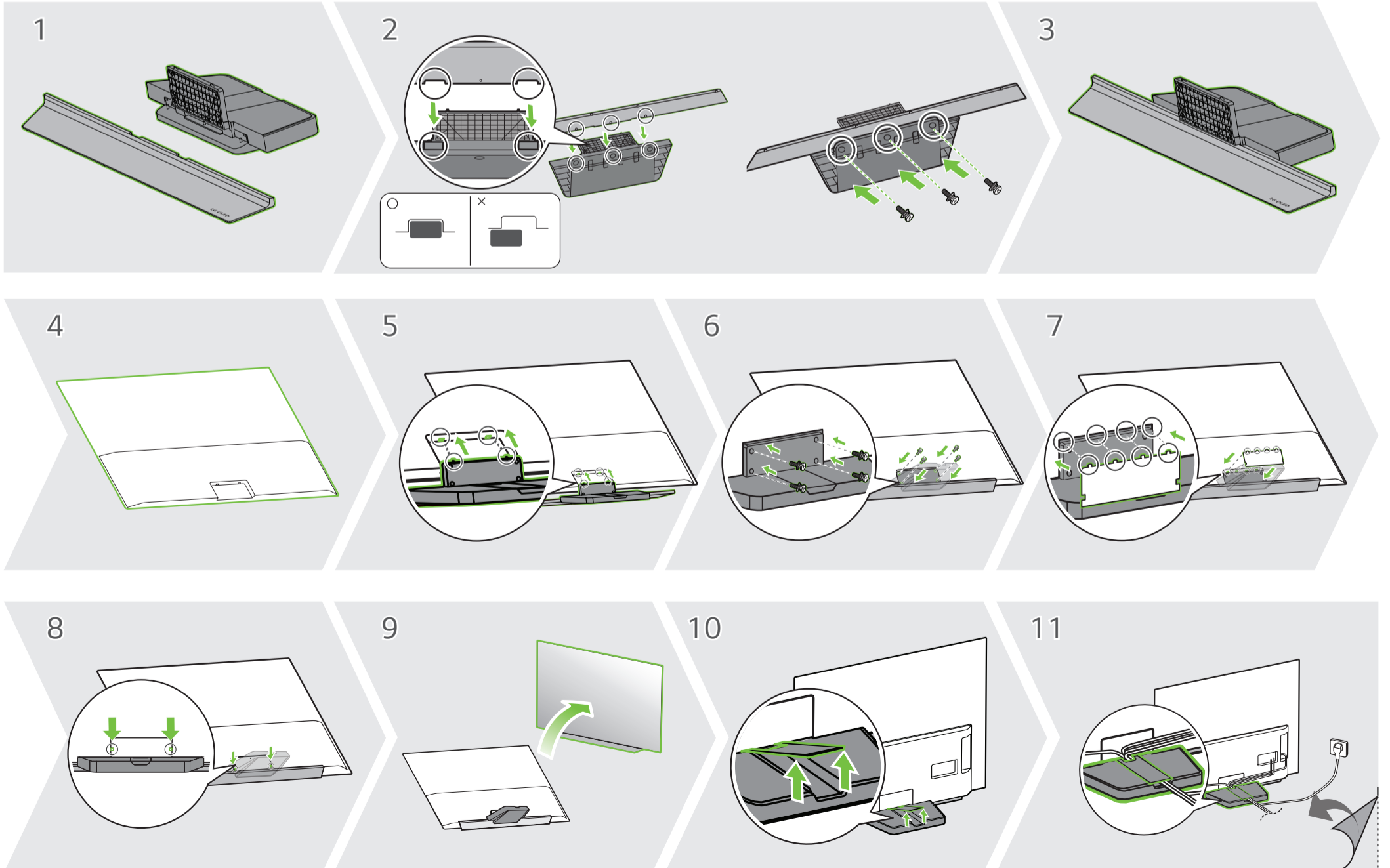
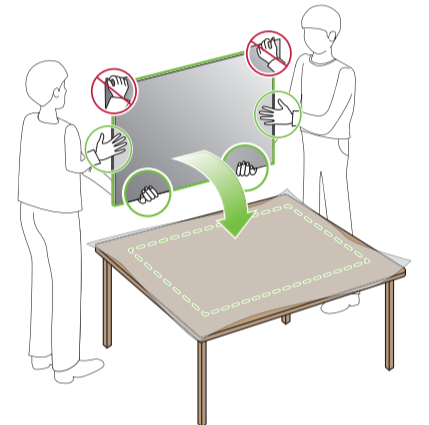

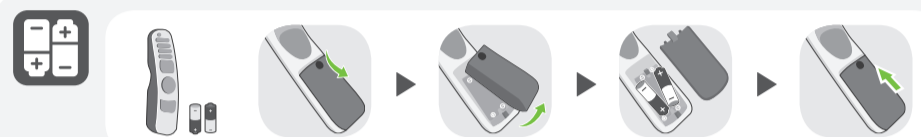
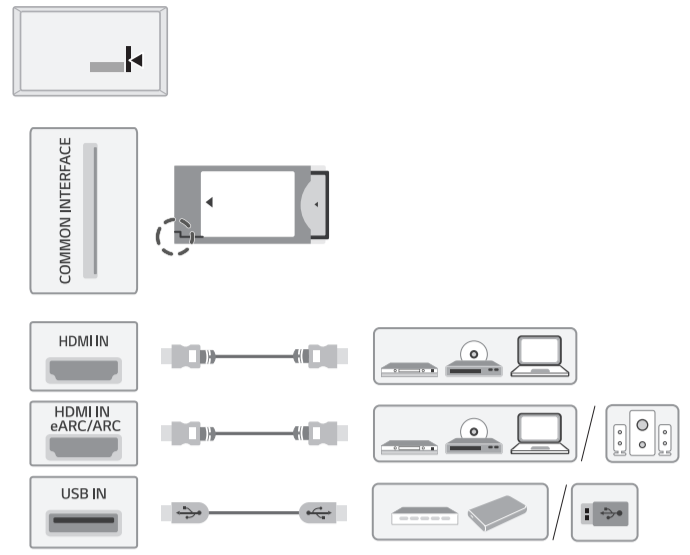
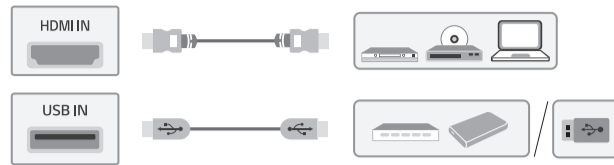
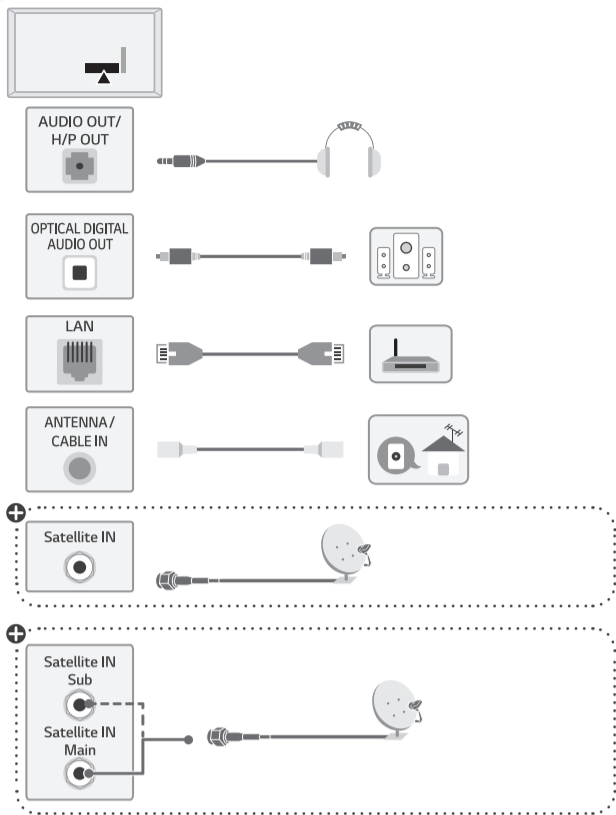

OLED55/65C1\*



OLED77C1\*

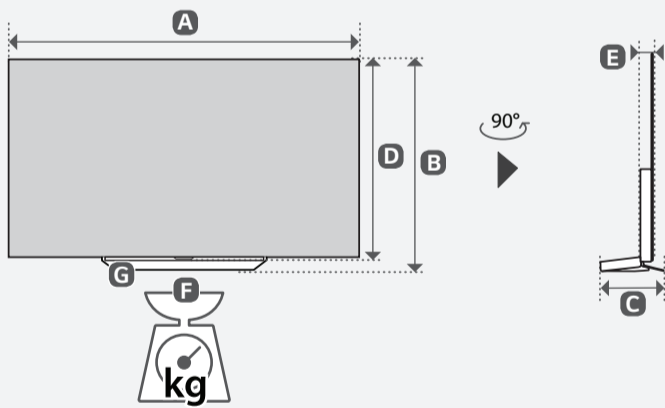

	A	B	C	D	E	F	F-G
	(mm)					(kg)	
OLED55C11LB OLED55C12LA OLED55C14LB OLED55C15LA OLED55C16LA OLED55C17LB OLED55C18LA OLED55C19LA OLED55C1RLA	1228	738	251	706	46.9	23.0	18.9
OLED65C11LB OLED65C12LA OLED65C14LB OLED65C15LA OLED65C16LA OLED65C17LB OLED65C18LA OLED65C19LA OLED65C1RLA	1449	862	251	830	46.9	32.6	24.0
OLED77C11LB OLED77C12LA OLED77C14LB OLED77C15LA OLED77C16LA OLED77C17LB OLED77C18LA OLED77C19LA OLED77C1RLA	1723	1023	269	993	55.3	35.9	26.7
Power requirement				AC 100-240 V ~ 50 / 60 Hz			



English	• Read Safety and Regulatory.	Hrvatski	• Pročitajte <b>Sigurnost i uskladenost s propisima.</b>	Română	• Consultați manualul referitor la <b>siguranță și reglementare.</b>
Deutsch	• Lesen Sie die <b>Sicherheitsanweisungen und Richtlinien.</b>	Shqip	• Lexoni paragrafin " <b>Siguria dhe rregullimi</b> ".	Български	• Прочетете <b>Безопасност и регулаторни стандарти.</b>
Français	• Lire le document <b>Sécurité et mesures réglementaires.</b>	Bosanski	• Pročitajte dio <b>Sigurnost i propisi.</b>	Eesti	• Lugege <b>ohutus- ja normatiivteavet.</b>
Italiano	• Leggere il manuale <b>Sicurezza e normative.</b>	Македонски	• Прочитajte за <b>безбедноста и регулативата.</b>	Lietuvių k.	• Perskaitykite <b>Saugos ir norminius reikalavimus.</b>
Español	• Leer <b>Seguridad y normativa.</b>	Svenska	• Läs <b>Säkerhet och föreskrifter.</b>	Latviešu	• Izlasiet sadaļu <b>Drošība un normatīvi.</b>
Português	• Ler informações sobre a <b>Segurança e Regulamentos.</b>	Magyar	• Biztonsági szabályzat megtekintése.	Srpski	• Pročitajte odeljak <b>Bezbednost i regulatorna pitanja.</b>
Nederlands	• <b>Veiligheidsinformatie en regelgeving</b> lezen.	Polski	• Prosimy o przeczytanie <b>Zasad bezpieczeństwa i uwag dotyczących przepisów.</b>	Norsk	• Les <b>sikkerhet og forskrifter.</b>
Ελληνικά	• Διαβάστε τις <b>οδηγίες για την ασφάλεια και τους κανονισμούς.</b>	Česky	• Přečtěte si část <b>Bezpečnost a zákonné předpisy.</b>	Dansk	• Læs <b>sikkerhed og lovmæssige bestemmelser.</b>
Slovenščina	• Preberite <b>varnostne in regulativne vidike.</b>	Slovenčina	• Prečítajte si <b>bezpečnostné a regulačné informácie.</b>	Suomi	• Lue <b>Turvallisuus ja säännökset</b> -osio.

⊕ : Depending on model / Abhängig vom Modell / Selon le modèle / In base al modello / En función del modelo / Dependendo do modelo / Afhankelijk van het model / Av λογα με το μοντ λο / Odvisno od modela / Tipusfüggő / Zależnie od modelu / Závísí na modelu / V závislosti od modelu / In funcție de model / В зависимости от модели / Sõltub mudelist / Priklauso nuo modelio / Atkarībā no modeļa / U zavisnosti od modela / Ovisno o modelu / Në varësi të modelit / Ovisno o modelu / во зависност од моделот / Beroende på modell / Avhengig av modell / Afhængigt af modellen / Mallin mukaan