

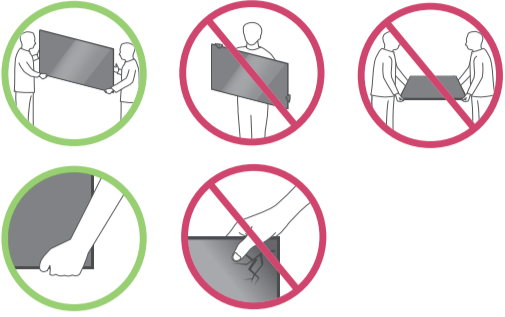

QNE81*
QNE82*

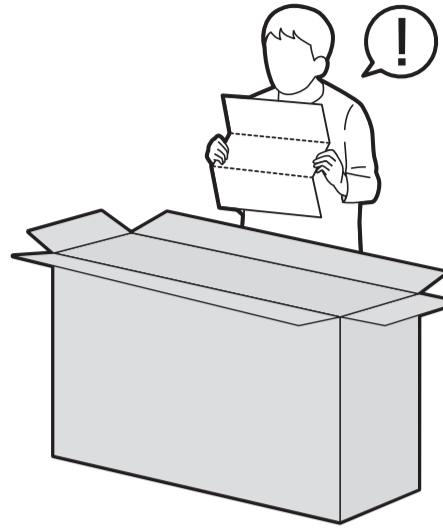

55QNE81/82*

A-1

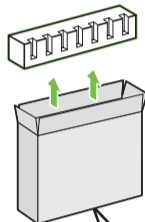

A-2

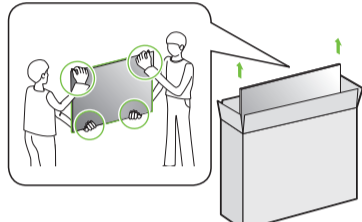

B-1

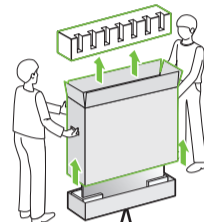

B-2

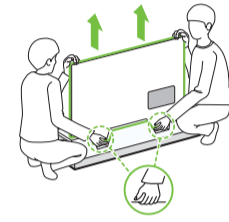

A,B-3

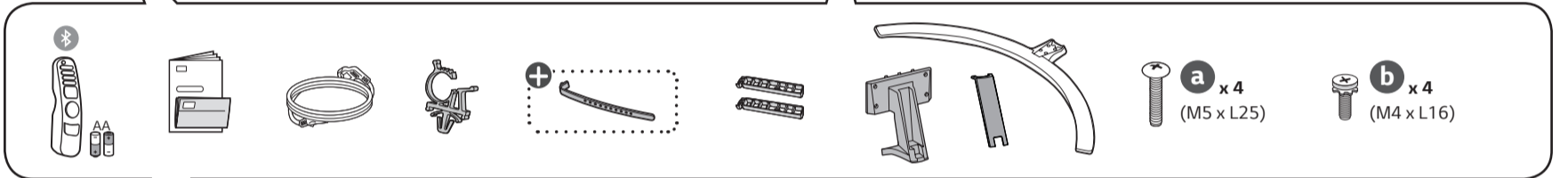
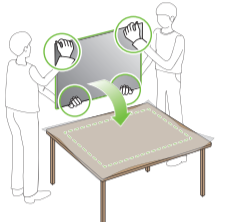

65QNE81/82*

1

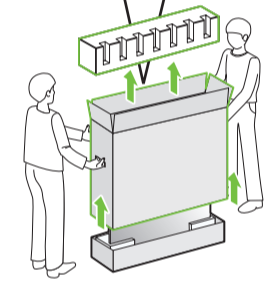

2

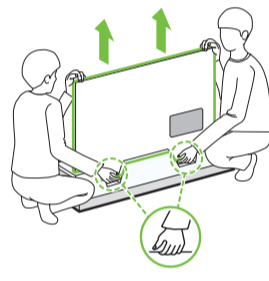

3

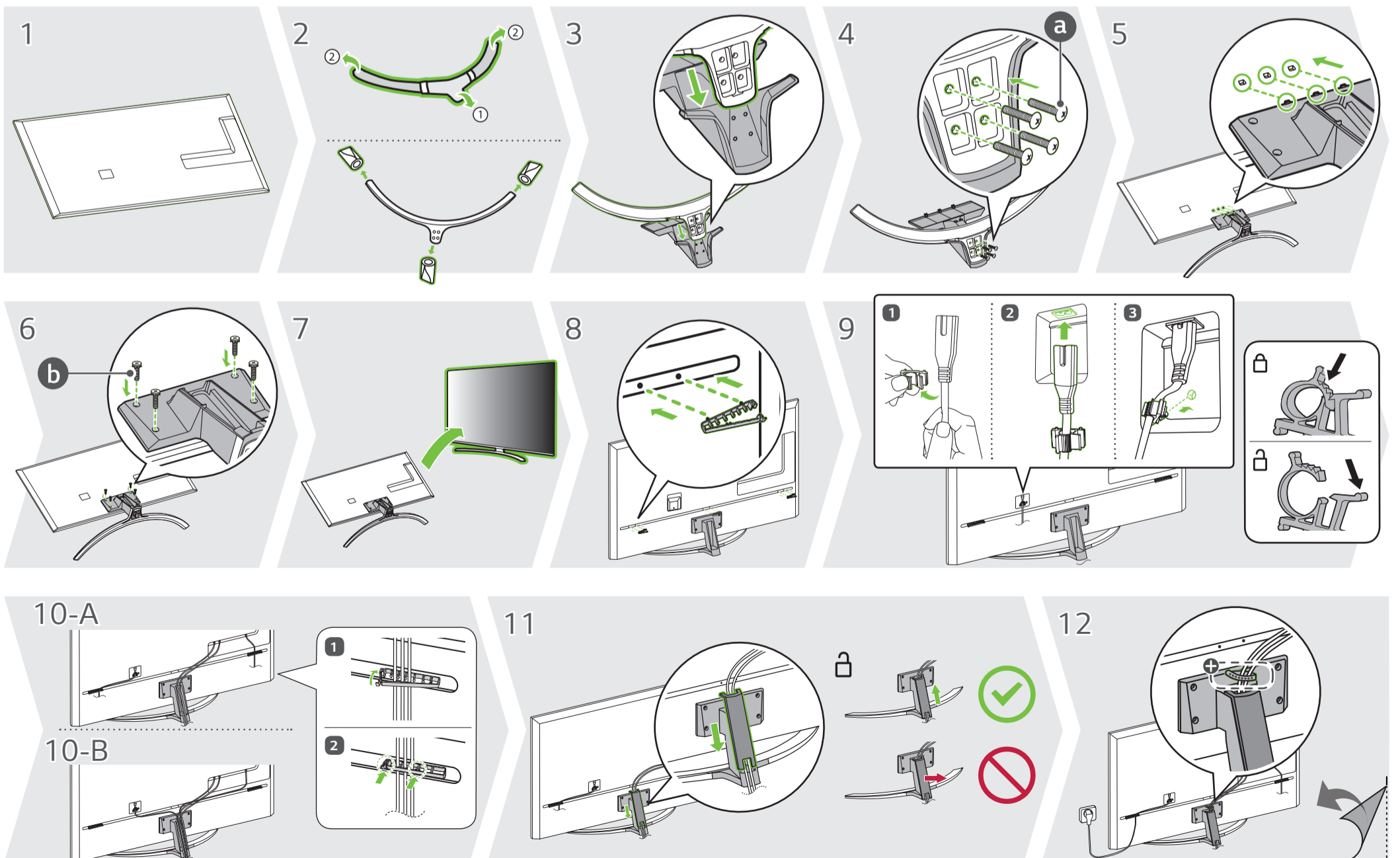
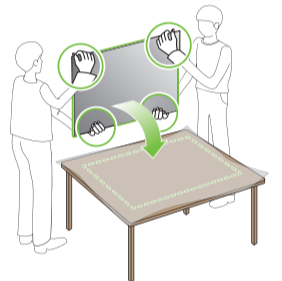

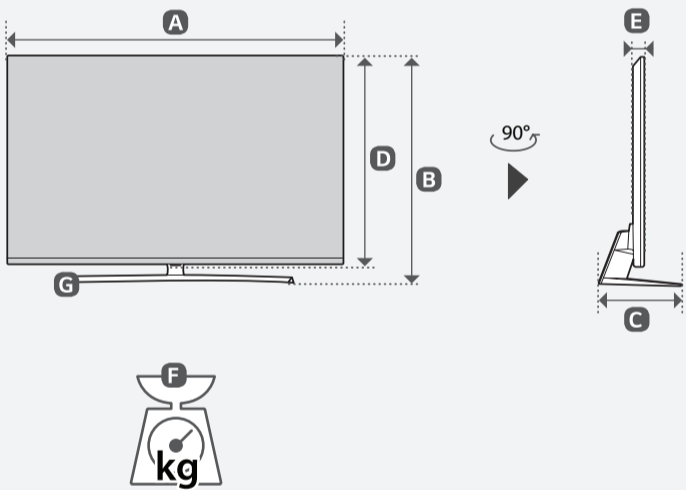
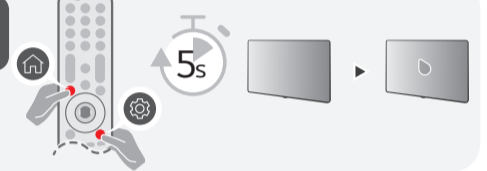
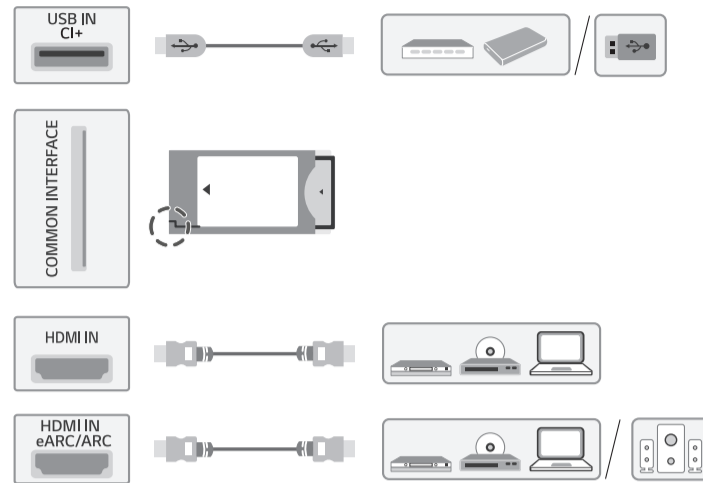
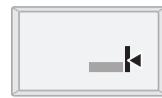
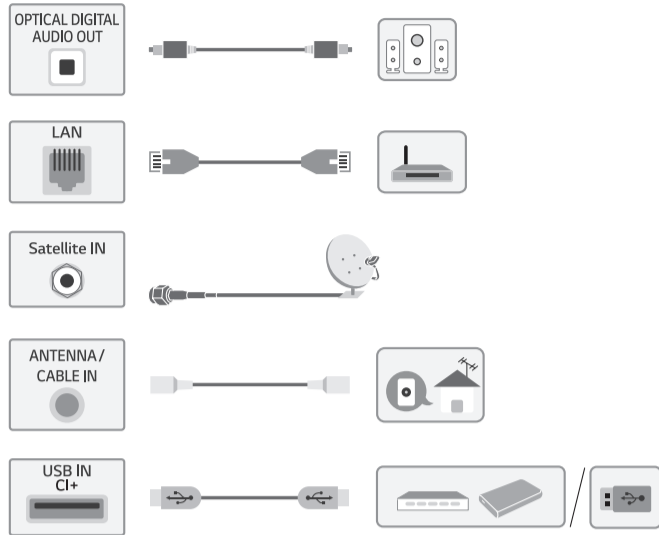

	A	B	C	D	E	F	F-G	
	(mm)			(kg)				
55QNED813QA 55QNED816QA 55QNED819QA 55QNED823QB 55QNED826QB 55QNED829QB	1233	781	271	716	44.2	17.9	16.3	
65QNED813QA 65QNED816QA 65QNED819QA 65QNED823QB 65QNED826QB 65QNED829QB	1452	911	336	839	44.3	26.2	24.5	
Power requirement	AC 100-240 V~ 50/60 Hz							

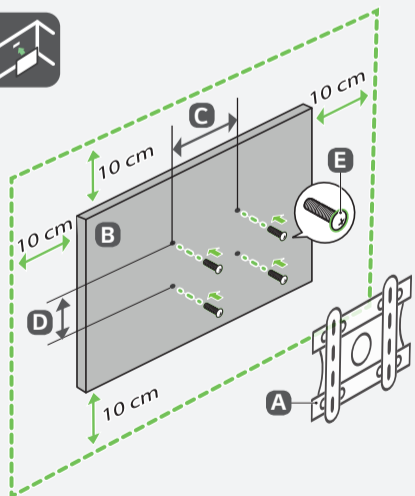

A	B	C x D (mm)	E
OLW480B	55QNED81*	300 x 300	M6
MSW240	55QNED82*	300 x 300	M6
OLW480B	65QNED81*	300 x 300	M6
	65QNED82*	300 x 300	M6

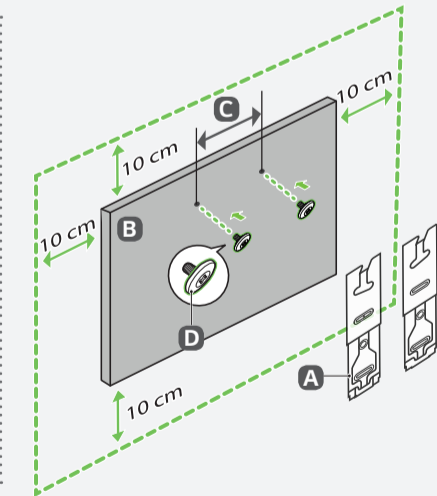

A	B	C (mm)	D
WB21LMB	55/65QNED81* 55/65QNED82*	300	M6



- English · Read Safety and Regulatory.
- Deutsch · Lesen Sie die **Sicherheitsanweisungen und Richtlinien**.
- Français · Lire le document **Sécurité et mesures réglementaires**.
- Italiano · Leggere il manuale **Sicurezza e normative**.
- Español · Leer **Seguridad y normativa**.
- Português · Ler informações sobre a **Segurança e Regulamentos**.
- Nederlands · **Veiligheidsinformatie en regelgeving** lezen.
- Ελληνικά · Διαβάστε τις **οδηγίες για την ασφάλεια και τους κανονισμούς**.
- Slovenščina · Preberite **varnostne in regulativne vidike**.

- Hrvatski · Pročitajte **Sigurnost i usklađenost s propisima**.
- Shqip · Lexoni paragrafin "**Siguria dhe rregullimi**".
- Bosanski · Pročitajte dio **Sigurnost i propisi**.
- Македонски · Прочитајте за **безбедноста и регулативата**.
- Svenska · Läs **Säkerhet och föreskrifter**.
- Magyar · Biztonsági szabályzat megtekintése.
- Polski · Prosimy o przeczytanie **Zasad bezpieczeństwa i uwag dotyczących przepisów**.
- Česky · Přečtěte si část **Bezpečnost a zákonné předpisy**.
- Slovenčina · Prečítajte si **bezpečnostné a regulačné informácie**.

- Română · Consultați manualul referitor la **siguranță și reglementare**.
- Български · Прочетеете **Безопасност и регулаторни стандарти**.
- Eesti · Lugege **ohutus- ja normatiivteavet**.
- Lietuvių k. · Perskaitykite **Saugos ir norminius reikalavimus**.
- Latviešu · Izlasiet sadaļu **Drošība un normatīvi**.
- Srpski · Pročitajte odeljak **Bezbednost i regulatorna pitanja**.
- Norsk · Les **sikkerhet og forskrifter**.
- Dansk · Læs **sikkerhed og lovmæssige bestemmelser**.
- Suomi · Lue **Turvallisuus ja säännökset**-osio.

⊕ : Depending on model / Abhängig vom Modell / Selon le modèle / In base al modello / En función del modelo / Dependendo do modelo / Afhankelijk van het model / Av λόγω με το μοντ λο / Odvisno od modela / Típusfüggő / Zależnie od modelu / Závisí na modelu / V závislosti od modelu / In functie de model / В зависимости от модели / Sõltub mudelist / Priklauso nuo modelio / Atkarībā no modeļa / U zavisnosti od modela / Ovisno o modelu / Në varësi të modelit / Ovisno o modelu / во зависност од моделот / Beroende på modell / Avhengig av modellen / Mallin mukaan