

**PHILIPS**

Televisions

4000 series

32PFL4902



Register your product and get support at

[www.philips.com/support](http://www.philips.com/support)

---

EN **User manual**

---

ES **Manual del usuario**

---

EN **For further assistance, call the customer support service in your country.**

- To obtain assistance, contact Philips customer care center;  
México D.F. and área metropolitana; **58 87 97 36**  
Interior de la republica; **01 800 839 19 89**  
Colombia; **01 800 952 0640**  
Costa Rica; **0800 052 1564**  
Guatemala; **1 800 835 0351**

ES **Para obtener más información, llame al centro de atención a clientes de su país.**

- Para obtener asistencia, póngase en contacto con el CENTRO DE INFORMACION AL CLIENTE,  
México D.F. y área metropolitana; **58 87 97 36**  
Interior de la republica; **01 800 839 19 89**  
Colombia; **01 800 952 0640**  
Costa Rica; **0800 052 1564**  
Guatemala; **1 800 835 0351**

# Contents

<b>1 Notice</b>	5	<b>Search for channels</b>	34
		Install channels	34
<b>2 Getting started</b>	7	<b>Channel settings</b>	34
Features	7	Channel installation	34
Included accessories	7	Child lock	35
Symbols used in this User manual	7	Change PIN	36
Attaching the base	8	Digital audio language	36
Installing the remote control batteries	8	Mono/Stereo	36
Remote control	9	<b>Connect to network</b>	37
Control panel	10	Wireless setting	37
Terminals	10	Wired setting	37
Connecting Antenna or Cable / Satellite / IPTV set-top box	11	<b>Network settings</b>	38
Plugging in the AC power cord	11	Manual network settings	38
Selecting your connection quality	12	Connection test	40
Connecting your devices	12	Setting status	40
Initial setup	16	Home network	41
		Wake-on-LAN(DIAL)	41
		Net TV	41
		Reset network settings	41
<b>3 Use your TV</b>	18	<b>Update software</b>	42
Switching on your TV and putting it in standby mode	18	Preparing for the software upgrade	42
Adjusting volume	18	Downloading the software	42
Switching channels	18	USB upgrade	42
Watching channels from an external device	19	Network updates	43
Access the Home menu	19	<b>Software settings</b>	43
Create a list of favorite channels	20	Software	43
Changing Picture format	20	View photos, play music and watch videos using home network	44
TV screen information	21	Net TV	46
Using options menu	22		
USB	23		
<b>4 Getting more from your TV</b>	26	<b>5 Useful tips</b>	48
Picture and sound setup	27	FAQ	48
<b>TV settings</b>	27	Troubleshooting tips	49
Picture	27		
Sound	29	<b>6 Information</b>	51
Features	30	Glossary	51
Installation	30	Maintenance	51
Accessibility	32		
		<b>7 Specifications</b>	52
		<b>8 Warranty</b>	53
		License	end of book

• Displays and illustrations may differ depending on the product you purchase.

## Know these **safety** symbols



The caution marking is located on the rear or bottom of the cabinet.



The lightning flash with arrowhead symbol, within an equilateral triangle, is intended to alert the user to the presence of uninsulated “dangerous voltage” within the apparatus’s enclosure that may be of sufficient magnitude to constitute a risk of electric shock to persons.



The exclamation point within an equilateral triangle is intended to alert the user to the presence of important operating and maintenance (servicing) instructions in the literature accompanying the apparatus.

**WARNING:** To reduce the risk of fire or electric shock, do not expose this apparatus to rain or moisture. Apparatus shall not be exposed to dripping or splashing and no objects filled with liquids, such as vases, shall be placed on the apparatus.

**CAUTION:** To prevent electric shock, match wide blade of plug to wide slot, fully insert.

**ATTENTION:** Pour éviter les choc électriques, introduire la lame la plus large de la fiche dans la borne correspondante de la prise et pousser jusqu’au fond.

**PHILIPS** Visit our World Wide Web Site at [www.philips.com/support](http://www.philips.com/support)

## CHILD SAFETY:

### PROPER TELEVISION PLACEMENT MATTERS

#### THE CONSUMER ELECTRONICS INDUSTRY CARES

- Manufacturers, retailers and the rest of the consumer electronics industry are committed to making home entertainment safe and enjoyable.
- As you enjoy your television, please note that all televisions – new and old- must be supported on proper stands or installed according to the manufacturer’s recommendations. Televisions that are inappropriately situated on dressers, bookcases, shelves, desks, speakers, chests, carts, etc., may fall over, resulting in injury.

#### TUNE IN TO SAFETY

- **ALWAYS** follow the manufacturer’s recommendations for the safe installation of your television.
- **ALWAYS** read and follow all instructions for proper use of your television.
- **NEVER** allow children to climb on or play on the television or the furniture on which the television is placed.
- **NEVER** place the television on furniture that can easily be used as steps, such as a chest of drawers.
- **ALWAYS** install the television where it cannot be pushed, pulled over or knocked down.
- **ALWAYS** route cords and cables connected to the television so that they cannot be tripped over, pulled or grabbed.

#### WALL OR CEILING MOUNT YOUR TELEVISION

- **ALWAYS** contact your retailer about professional installation if you have any doubts about your ability to safely mount your television.
- **ALWAYS** use a mount that has been recommended by the television manufacturer and has a safety certification by an independent laboratory (such as UL, CSA, ETL).
- **ALWAYS** follow all instructions supplied by the television and mount manufacturers.
- **ALWAYS** make sure that the wall or ceiling where you are mounting the television is appropriate. Some mounts are not designed to be mounted to walls and ceilings with steel studs or cinder block construction. If you are unsure, contact a professional installer.
- Televisions can be heavy. A minimum of two people is required for a wall or ceiling mount installation.

#### MOVING AN OLDER TELEVISION TO A NEW PLACE IN YOUR HOME

- Many new television buyers move their older CRT televisions into a secondary room after the purchase of a flat-panel television. Special care should be made in the placement of older CRT televisions.
- **ALWAYS** place your older CRT television on furniture that is sturdy and appropriate for its size and weight.
- **NEVER** place your older CRT television on a dresser where children may be tempted to use the drawers to climb.
- **ALWAYS** make sure your older CRT television does not hang over the edge of your furniture.

**CTA.tech/safety** Consumer Technology Association™

# Important safety instructions

1. Read these instructions.
2. Keep these instructions.
3. Heed all warnings.
4. Follow all instructions.
5. Do not use this apparatus near water.
6. Clean only with dry cloth.
7. Do not block any ventilation openings. Install in accordance with the manufacturer's instructions.
8. Do not install near any heat sources such as radiators, heat registers, stoves, or other apparatus (including amplifiers) that produce heat.
9. Do not defeat the safety purpose of the polarized or grounding type plug. A polarized plug has two blades with one wider than the other. A grounding type plug has two blades and a third grounding prong. The wide blade or the third prong are provided for your safety. If the provided plug does not fit into your outlet, consult an electrician for replacement of the obsolete outlet.
10. Protect the power cord from being walked on or pinched particularly at plugs, convenience receptacles, and the point where they exit from the apparatus.
11. Only use attachments / accessories specified by the manufacturer.
12. Use only with the cart, stand, tripod, bracket, or table specified by the manufacturer, or sold with the apparatus. When a cart is used, use caution when moving the cart / apparatus combination to avoid injury from tip-over.



13. Unplug this apparatus during lightning storms or when unused for long periods of time.
14. Refer all servicing to qualified service personnel. Servicing is required when the apparatus has been damaged in any way, such as power-supply cord or plug is damaged, liquid has been spilled or objects have fallen into the apparatus, the apparatus has been exposed to rain or moisture, does not operate normally, or has been dropped.

## Note to the CATV system installer:

This reminder is provided to call the CATV system installer's attention to Article 820-40 of the NEC that provides guidelines for proper grounding and, in particular, specifies that the cable ground shall be connected to the grounding system of the building, as close to the point of cable entry as practical.

## Example of antenna grounding as per NEC - National Electric Code

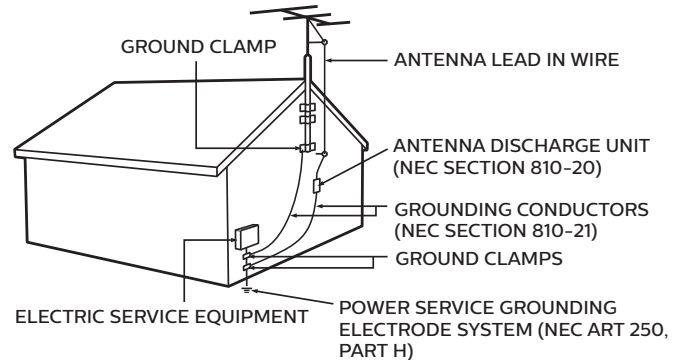

### Wall mount bracket kit

	Brand	Model #	Screw dimension
32PFL4902	SANUS	AST16	M4 x 35mm (1.378")

- Your TV meets the VESA standard for wall mounting. Consult with your local dealer for a wall mount bracket which is compatible with your TV model.
- The recommended wall mount bracket kit (sold separately) allows the mounting of the TV on the wall.
- For detailed information on installing the wall mount, refer to the wall mount Instruction book.
- P&F Mexicana is not responsible for any damage to the product or injury to yourself or others if you elect to install the TV wall mount bracket or mount the TV onto the bracket on your own.
- The wall mount bracket must be installed by experts.

### P&F Mexicana is not liable for these types of accidents or injuries noted below.

- Install the wall mount bracket on a sturdy vertical wall.
- If installed onto a ceiling or slanted wall, the TV and wall mount bracket may fall which could result in a severe injury.
- Do not use screws that are longer or shorter than their specified length. If screws too long are used this may cause mechanical or electrical damage inside the TV set. If screws too short are used this may cause the TV set to fall.
- Do not fasten the screws by excessive force. This may damage the product or cause the product to fall, leading to an injury.
- For safety reasons use 2 people to mount the TV onto a wall mounting bracket.
- Do not mount the TV onto the wall mounting bracket while your TV is plugged in or turned on. It may result in an electrical shock injury.

### When installing the unit on the wall, allow this much space.

Top	: 11.8 inches (30cm)
Left and right side	: 5.9 inches (15cm)
Bottom	: 3.9 inches (10cm)

# 1 Notice

Trademarks are the property of Koninklijke Philips N.V. or their respective owners.

P&F Mexicana reserves the right to change products at any time without being obliged to adjust earlier supplies accordingly.

The material in this manual is believed adequate for the intended use of the system. If the product or its individual modules or procedures are used for purposes other than those specified herein, confirmation of their validity and suitability must be obtained. P&F Mexicana warrants that the material itself does not infringe any United States patents. No further warranty is expressed or implied.

P&F Mexicana cannot be held responsible neither for any errors in the content of this document nor for any problems as a result of the content in this document. Errors reported to P&F Mexicana will be adapted and published on the P&F Mexicana support website as soon as possible.

## Pixel characteristics

This LCD product has a high number of color pixels. Although it has effective pixels of 99.999% or more, black dots or bright points of light (red, green or blue) may appear constantly on the screen. This is a structural property of the display (within common industry standards) and is not a malfunction.

## Warranty

No components are user serviceable. Do not open or remove covers to the inside of the product. Repairs may only be done by service centers and official repair shops. Failure to do so shall void any warranty, stated or implied.

Any operation expressly prohibited in this manual, any adjustments or assembly procedures not recommended or authorized in this manual shall void the warranty.

## Positioning the TV

- Large screen TVs are heavy. 2 people are required to carry and handle a large screen TV.
- Make sure to hold the upper and bottom frames of the unit firmly as illustrated.
- Install the unit in a horizontal and stable position.
- Do not install the unit in direct sunlight or in a place subject to dust or strong vibration.
- Depending on the environment, the temperature of this unit may increase slightly. This is not a malfunction.
- When installing this unit in a temperate environment, avoid a place with rapid temperature changes.
  - Operating temperature: 41°F (5°C) to 104°F (40°C)
- This unit should not be used in a tropical environment as it has not been evaluated under such conditions.
- No objects should be placed directly on or under this unit, especially lighted candles or other flaming objects.
- Depending on your external devices, noise or disturbance of the picture and / or sound may be generated if the unit is placed too close to them. In this case, please ensure enough space between the external devices and the unit.
- Do not insert the AC power cord into the power socket outlet before all the connections are made.
- Ensure that you always have easy access to the AC power cord and outlet to disconnect the TV from the AC outlet.
- Before you move the TV, disconnect attached cables to prevent damage to connectors, especially the TV tuner.
- Be sure to unplug the AC power plug from the AC outlet before moving or carrying the unit.
- When moving the TV and then setting it down, please be careful not to pinch the AC power cord under the unit.
- Do not place this unit in an area where it may be exposed to water, oil or grease such as:
  - near a bathtub, basin, kitchen sink, washing tub, swimming pool, kitchen exhaust fan, etc., or in a damp basement.

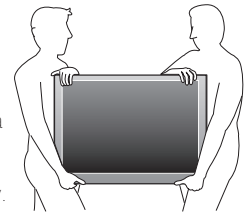

## Regulatory notices

**WARNING:** To prevent injury, this apparatus must be securely attached to the furniture / wall in accordance with the instructions. Tipping, shaking or rocking the unit may cause injury / death.

- WARNING:** Never place a TV in an unstable location. A TV may fall, causing serious personal injury or death. Many injuries, particularly to children, can be avoided by taking simple precautions such as:
- Using cabinets or stands recommended by the manufacturer of the TV.
  - Only using furniture that can safely support the TV.
  - Ensuring the TV is not overhanging the edge of the supporting furniture.
  - Not placing the TV on tall furniture (for example, cupboards or bookcases) without anchoring both the furniture and the TV to a suitable support.
  - Not placing the TV on cloth or other materials that may be located between the TV and supporting furniture.
  - Educating the children about the dangers of climbing on furniture to reach the TV or its controls.

If your existing TV is being retained and relocated, the same considerations as above should be applied.

Do not place the unit on the furniture that is capable of being tilted by a child and an adult leaning, pulling, standing or climbing on it. A falling unit can cause serious injury or even death.

In order to avoid interruption of ventilation, this unit should not be placed in built-in equipment such as a book cabinet, rack, etc., and the vents of this unit should not be covered with anything such as a tablecloth, curtain, newspaper, etc. Make sure that there is enough ventilation space (4 inches / 10 cm or more) around this unit.

Press  to turn the unit on and go into standby mode. To completely turn off the unit, you must unplug the AC power plug from the AC power outlet. Disconnect the AC power plug to shut the unit off when trouble is found or not in use. The AC plug shall remain readily available.

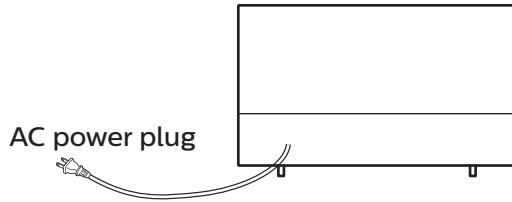

Never use a gas duster on this TV. The gas trapped inside of this unit may cause ignition and explosion.

### Environmental care



The packaging of this product is intended to be recycled. Contact your local authorities for information about how to recycle the packaging.

For product recycling information, please visit - [www.recycle.philips.com](http://www.recycle.philips.com)

### End of life directives

Philips pays a lot of attention to produce environmental-friendly products in green focal areas. Your new TV contains materials which can be recycled and reused. At the end of its life, specialized companies can dismantle the discarded TV to concentrate the reusable materials and to minimize the amount of materials to be disposed of. Please ensure you dispose of your old TV according to local regulations.

### Batteries usage

**CAUTION** : Danger of explosion if battery is incorrectly replaced. Replace only with the same or equivalent type.

**WARNING** : Batteries (battery pack or battery installed) should not be exposed to excessive heat such as sunshine, fire or the like.

- Do not mix old and new batteries.
- Do not mix alkaline, standard (carbon-zinc) or rechargeable (ni-cad, ni-mh, Li-ion, etc.) batteries.

### Disposal of used batteries

The batteries included do not contain the heavy metals mercury and cadmium, however in certain localities, disposing batteries with household waste is not permitted. Please ensure you dispose of batteries according to local regulations.

### Preparing to move / ship the unit

Please pack the unit properly by following the diagram on the carton (as noted below).

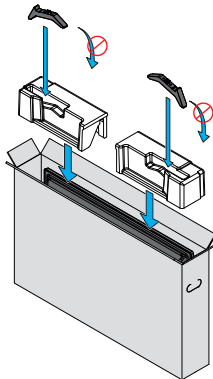

- To avoid damage to the screen, do not pack the stand on the same side as the TV screen, refer to the illustration above.

### Copyright

All other registered and unregistered trademarks are the property of their respective owners.



The terms HDMI and HDMI High-Definition Multimedia Interface, and the HDMI Logo are trademarks or registered trademarks of HDMI Licensing Administrator, Inc. in the United States and other countries.



Dolby, Dolby Audio, and the double-D symbol are trademarks of Dolby Laboratories.



Sonic Emotion and the Sonic Emotion logo symbol are registered trademarks of sonic emotion ag.



Netflix is available in certain countries. Streaming membership required. More information at [www.netflix.com](http://www.netflix.com).



YouTube and the YouTube logo are trademarks of Google Inc.



**HOTLIST**



**SAMBA TV**

Hotlist, Samba, Samba TV and associated logos are trademarks of Free Stream Media Corp.

Portions of this software are copyright © The FreeType Project ([www.freetype.org](http://www.freetype.org)).

The American Academy of Pediatrics discourages television viewing for children younger than two years of age.

Some features may require an always-on broadband internet connection, firmware update and/or a minimum bandwidth. Internet services vary by location.

P&F USA Inc. / P&F MEXICANA, S.A.de C.V. do not warrant access to the portal or to any of the services, content, software and advertising. P&F USA Inc./P&F MEXICANA, S.A. de C.V. or third party content/service providers may, in their sole discretion, add or remove access to any specific services, content, software and advertising at any time. Although P&F USA Inc. / P&F MEXICANA, S.A. de C.V. will strive to provide a good selection of services, content or software, P&F USA Inc./ P&F MEXICANA, S.A. de C.V. do not warrant continued access to any specific services, and content or software.

# 2 Getting started

## Features

- **DTV / Analog TV / CATV**  
You can use your remote control to select channels which are broadcast in digital format and conventional analog format. Also, cable and satellite subscribers can access their TV channels.
- **Information display**  
You can display on the TV screen the title, contents (DTV only) and other information on the current program.
- **Autoprogram**  
This unit automatically scans and memorizes channels available in your area, eliminating difficult setup procedures.
- **Net TV**  
This unit lets you enjoy internet services. Use the remote control to browse the Net TV pages. You can play movies and much more, all from your TV screen.
- **Child lock**  
This feature allows you to block children's access to inappropriate programs.
- **Closed caption decoder**  
Built-in closed caption decoder displays text for closed caption supported programs.
- **MTS / SAP tuner**  
Audio can be selected from the remote control.
- **Auto standby**  
If there is no input signal and no operation for 15 minutes, the unit will go into standby mode automatically.
- **Sleep timer**  
You can set the unit to go into standby mode after a specific amount of time.
- **Choices for on-screen language**  
Select your on-screen language: English, Spanish or French.
- **Stereo sound function**
- **PLL frequency synthesized tuning**  
Provides free and easy channel selection and lets you tune directly to any channel using the number and decimal point "\*" keys on the remote control.
- **Various adjustments for picture and sound**  
Customizes picture quality suitable for your room and sets your sound preference.
- **EasyLink via HDMI link**  
EasyLink allows your other HDMI link devices to be controlled by the HDMI cable connected to your TV.
- **HDMI input**
- **HDMI-DVI input**  
If your video device has a DVI output jack, use an HDMI-DVI conversion cable to connect the unit.
- **Component video input**
- **AV input**  
Audio and video input from an external device.
- **USB terminal**  
The picture, music and video files stored on a USB memory stick can be played back on this unit.
- **Digital audio output**
- **Headphone audio output**  
Headphone 3.5mm stereo jack for personal listening.

## Included accessories

### User manual



### Quick start guide



### Remote control and Batteries (AAA, 1.5V x 2)



### TV base and Screws



Screws packed with this unit.

Model	Quantity	Size
32PFL4902	4	M4 x 14mm (0.551")

### Note(s)

- If you lose the screws, please purchase the above-mentioned Phillips head screws at your local store.
- If you need to replace these accessories, please refer to the part name or No. with the illustrations and call our toll free customer support line found on the cover of this User manual.

#### When using a universal remote control to operate this unit.

- Make sure the component code on your universal remote control is set to our brand. Refer to the instruction book accompanying your remote control for more details.
- We do not guarantee 100% interoperability with all universal remote controls.

## Symbols used in this User manual

The following is the description for the symbols used in this User manual. Description refers to:

Digital TV operation

Cable / NTSC (Analog) TV operation

- If neither symbol appears, the operation is applicable to both.

## Attaching the base

You must attach the base to the unit to have it as a table top unit. Be sure the front and rear of the base match the proper direction. For large screen TVs, at least 2 people are required for these steps.

1

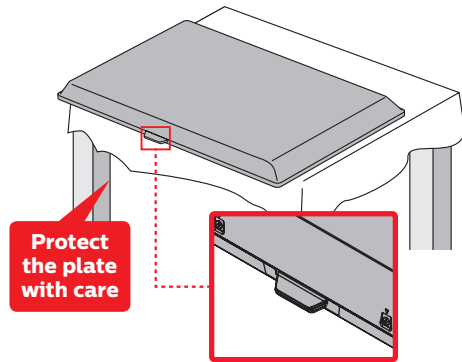

2

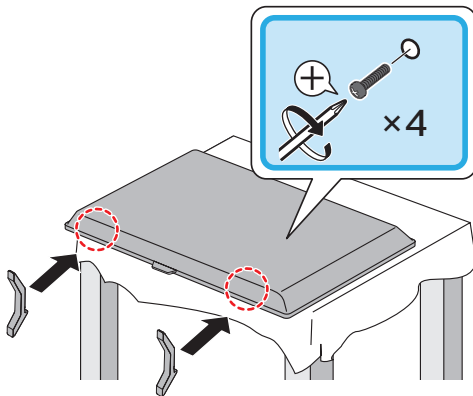

3

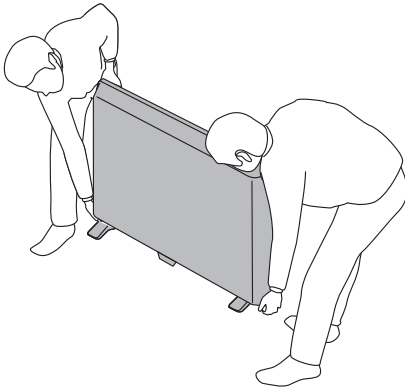

### Note(s)

- Make sure to use a table which can support the weight of this unit and is larger than this unit.
- Make sure the table is in a stable location.
- A Phillips-head screwdriver is required to fasten the stands to the TV set.
- When attaching the base, ensure that all screws are tightly fastened. If the base is not properly attached, it could cause the unit to fall, resulting in injuries as well as damage to the unit.
- To remove the base from this unit, unscrew the Phillips-head screws by reversing the procedure. Be careful not to drop the base when you remove it.

## Installing the remote control batteries

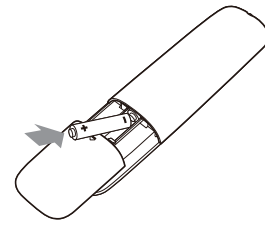

- 1 Slide the battery cover off the back of the remote control.
- 2 Insert the two included batteries (AAA, 1.5V). Be sure the + and – ends of the batteries line up with the markings inside the case.
- 3 Slide the cover back into position.

### Note(s)

- Remove the batteries if not using the remote control for an extended period of time.



## Remote control

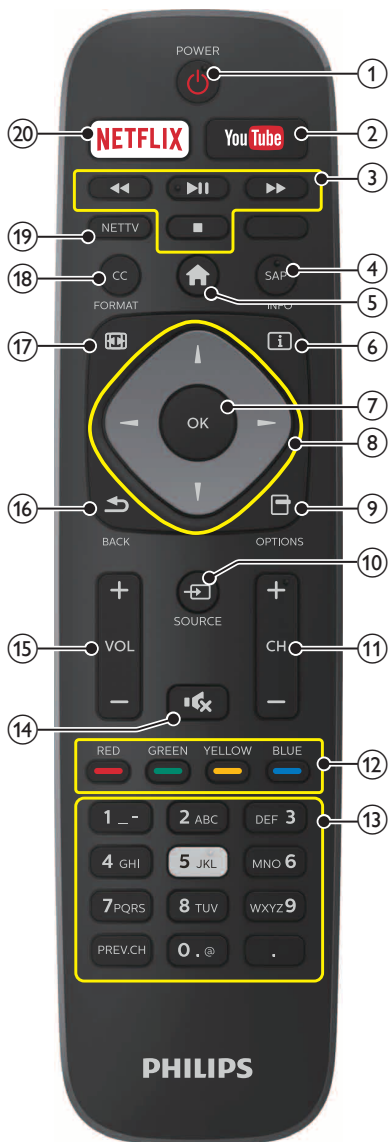

- ① **⏻ (POWER)**  
Turns the TV on from standby or off to standby.
  - ② **YouTube**  
Access directly to YouTube.
  - ③ **EasyLink buttons**
    - ◀▶/▶▶ : Searches backward or forward through the disc.
    - ▶|| : Starts, pauses or resumes playback.
    - : Stops the disc playback.
- Note(s)**

  - Pause may not work properly on some devices even if they are EasyLink (HDMI CEC) compliant.
- ④ **SAP**  
Selects audio mode (MONO / STEREO / SAP) / audio language.
  - ⑤ **🏠 (Home)**  
Displays the main menu.
  - ⑥ **ℹ INFO**  
Displays information about the current program.
  - ⑦ **OK**  
Press to decide the command of setting when the Home menu is displayed.
  - ⑧ **▲▼◀▶ (NAVIGATION buttons)**  
Moves the cursor, selects the on-screen menu items.
  - ⑨ **□ OPTIONS**  
Displays a list of menu items applicable to the highlighted object or screen.
  - ⑩ **⊞ SOURCE**  
Selects connected devices.
  - ⑪ **CH + / -**  
Selects a channel.
  - ⑫ **COLOR buttons**  
Works as direct access to user specified net apps.
  - ⑬ **0 - 9 (NUMBER buttons)**  
Used to enter a channel / program number.
    - (DOT) : Use with 0-9 to select digital channels.  
For example, to enter 2.1, press
- 
- PREV.CH** : Returns to the previously viewed channel.
- ⑭ **🔇 (MUTE)**  
Turns the sound on and off.
  - ⑮ **VOL + / -**  
Adjusts the volume.
  - ⑯ **↶ BACK**  
Returns to the previous menu operation.
  - ⑰ **⊞ FORMAT**  
Adjusts the picture size on the TV screen.
  - ⑱ **CC**  
Selects closed caption settings (Off, On, CC w/ mute).
  - ⑲ **NETTV**  
Access to Net TV menu directly.
  - ⑳ **NETFLIX**  
Access directly to Netflix.

## Control panel

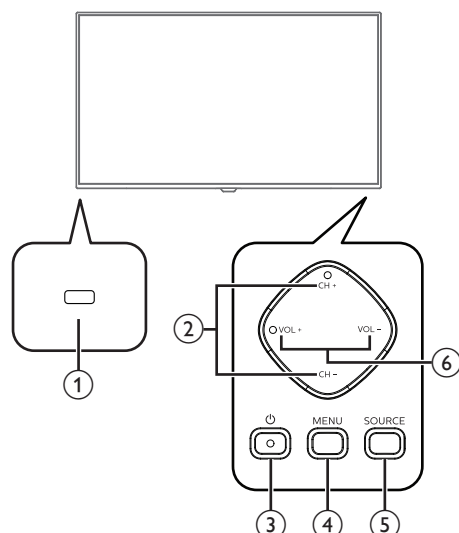

- ① **Remote control sensor**  
Receives IR signal from remote control.
- ② **CH + / -**  
Selects a channel. In the menu screen, moves the cursor up (+) / down (-).
- ③ **⏻ (POWER)**  
Turns the TV on or switches the TV into standby mode.
- ④ **MENU**  
Opens the main on-screen menu.
- ⑤ **SOURCE**  
Selects connected devices.
- ⑥ **VOL + / -**  
Adjusts the volume. In the menu screen, moves the cursor left (+) / right (-).  
**VOL +** : Volume up  
**VOL -** : Volume down

## Terminals

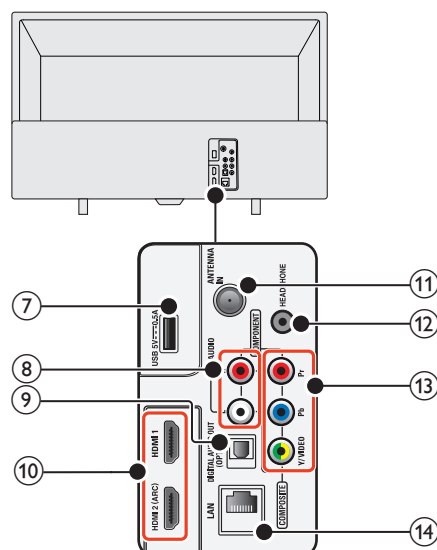

- ⑦ **USB terminal**  
Data input from USB memory stick only.  
Do not connect any device to this terminal such as digital camera, keyboard, mouse, etc.
- ⑧ **Analog audio (L/R) input jacks**  
Connect analog audio signals from;  
– HDMI-DVI / Analog audio (L/R) jacks signal  
– Component video / Analog audio (L/R) jacks signal  
– Composite video / Analog audio (L/R) jacks signal  
– PC connection / Analog audio (L/R) jacks signal with stereo mini 3.5mm plug audio cable on PC
- ⑨ **Digital audio output jack**  
Digital audio (S/PDIF) output to home theaters and other digital audio systems.
- ⑩ **HDMI input jack(s)**  
Digital audio and video input from high definition digital devices such as DVD / Blu-ray disc players, cable / satellite set-top boxes, PC's, etc.  
\* For HDMI 2 only  
In addition to normal HDMI and HDMI-DVI functionality, it outputs TV audio to an HDMI-ARC-compliant device, such as a home theater system.
- ⑪ **75 ohm cable / Antenna connection**  
Signal input from an antenna or cable / satellite set-top boxes.
- ⑫ **Headphone audio output jack**  
Headphone 3.5mm stereo jack for personal listening.
- ⑬ **Component (Y/Pb/Pr) / Composite video (VIDEO) input jack(s) for VIDEO**  
Composite video input (VIDEO) jack is a shared jack with component video input (Y) jack.
- ⑭ **Ethernet port**  
For internet connection using an Ethernet cable with an RJ-45 connector.

## Connecting Antenna or Cable / Satellite / IPTV set-top box

Be sure your antenna or another device is connected properly before plugging in the AC power cord.

### If connecting to an antenna through an RF cable

Any DTV programs that are broadcast in your area can be received for free through an antenna connection.

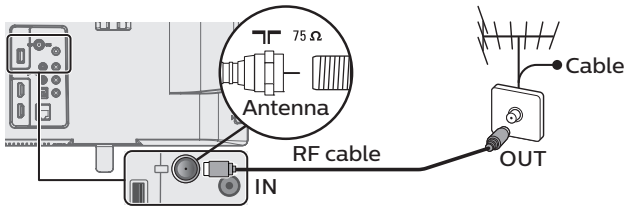

### If connecting Cable / Satellite / IPTV set-top box using an RF cable

If the TV is connected to a cable or set-top box via a coaxial connection, set the TV to channel 3/4 or the channel specified by the service provider.

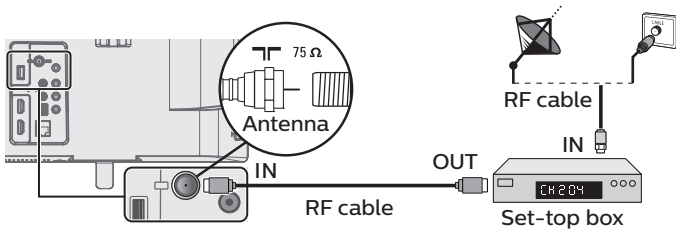

### If connecting Cable / Satellite / IPTV set-top box using an HDMI cable

If the TV is connected to a cable / satellite set-top box via an HDMI cable, make sure you select the correct source by using **SOURCE**.

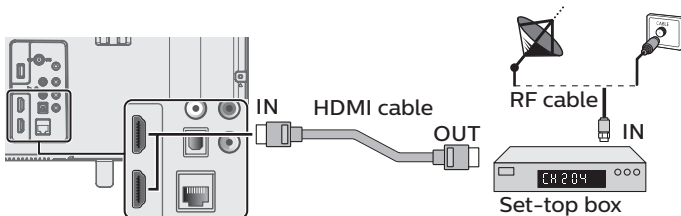

### If connecting Cable / Satellite / IPTV set-top box using component video input

If the TV is connected to a cable / satellite set-top box via component video input, make sure you select the correct component video source by using **SOURCE**.

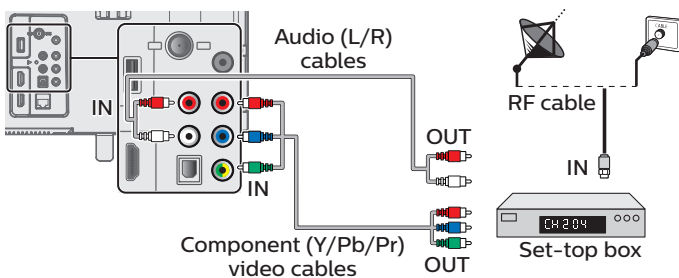

## Connecting a Cable / Satellite / IPTV set-top box, Blu-ray disc / DVD recorder via composite connectors and analog audio

Do not place your recorder too close to the screen because some recorders can be susceptible to harmful interference from the TV.

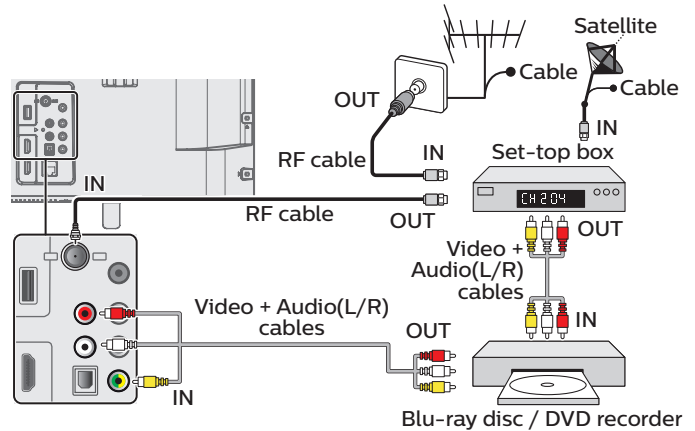

### Note(s)

- If you have any question about the DTV's antenna, visit [www.antennaweb.org](http://www.antennaweb.org) for further information.
- Depending on your antenna system, you may need different types of combiners (mixers) or separators (splitters) for HDTV signal. The minimum RF bandpass on these devices is 2,000MHz or 2GHz.
- For your safety and to avoid damage to this unit, please unplug the RF coaxial cable from the antenna input jack before moving the unit.
- If you did use an antenna to receive analog TV, it should also work for DTV reception. Outdoor or attic antennas will be more effective than a set-top box or inside antenna.
- To turn on your reception source easily between antenna and cable, install an antenna selector.
- If you are not receiving a signal from your cable service, contact the cable provider.

## Plugging in the AC power cord

Make sure that the AC power cord must be plugged to an AC outlet after all the necessary connections are made.

### Caution(s)

- Connect the analog audio signal cables from the external device to the analog audio L/R input jacks.
- If you have an amplifier, connect the HDMI cable to the HDMI input via your amplifier.

### Note(s)

- Each time you plug in the AC power cord, no operations will be performed for several seconds. This is not a malfunction.

**No included cables are used with these connections:**

- Please purchase the necessary cables at your local store.

**Before you connect the AC power cord:**

Be sure other devices are connected properly before plugging in the AC power cord.

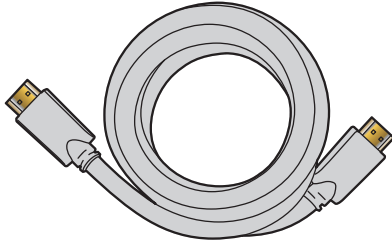
**Selecting your connection quality****HDMI - Highest quality**

Supports high-definition digital signals and gives highest picture and sound quality. Video and audio signals are combined in one cable. You must use HDMI for full high-definition video and to enable EasyLink(HDMI CEC).

**Note(s)**

- Philips HDMI supports HDCP (High-bandwidth Digital Contents Protection). HDCP is a form of digital rights management that protects high-definition content in Blu-ray discs or DVDs.
- The HDMI-ARC connector on the TV features HDMI-ARC functionality. This allows output of TV audio to an HDMI-ARC-compliant device.

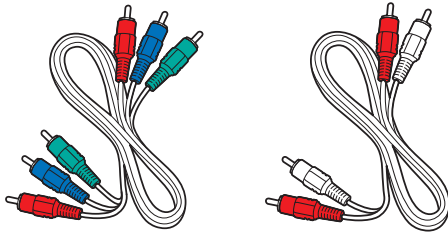
**Component (Y Pb Pr) - High quality**

Supports high-definition analog signals but gives lower picture quality than HDMI. Component (Y/Pb/Pr) video cables combine red / green / blue video cables with red / white audio (L/R) cables. Match the cable colors when you connect to the TV.

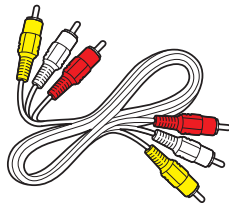
**Composite - Basic quality**

For analog connections. Composite video / Audio analog cable usually combine a yellow video cable with red / white audio (L/R) cables. With this unit, yellow cable must be connected to Y (green) jack on the component video input jacks.

**Connecting your devices****HDMI digital connection**

HDMI connection offers the highest picture quality. HDMI (High-Definition Multimedia Interface) transports high-definition digital video and multi-channel digital audio through a single cable.

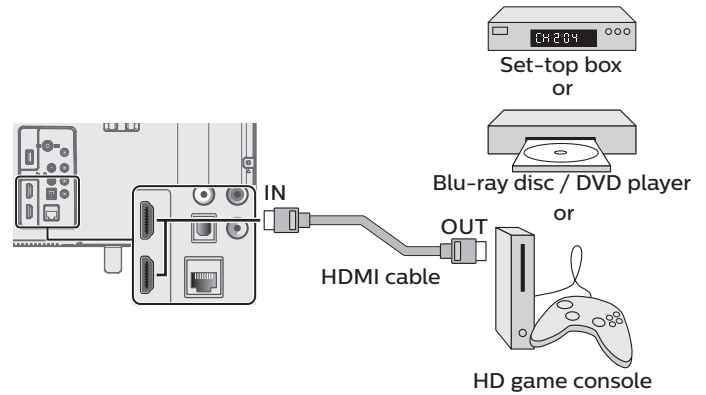
**Note(s)**

- Some HDMI cables and devices may not be compatible with the TV due to different HDMI specifications.
- Use an HDMI cable with the HDMI logo (a certified HDMI cable). High speed HDMI cable is recommended for the better compatibility.
- The unit accepts 480i / 480p / 720p / 1080i, 1080p 24/30/60Hz of video signals, 32kHz / 44.1kHz and 48kHz of audio signals.
- This unit accepts LPCM, AC-3, DD+ audio signal.
- This unit accepts only signals in compliance with EIA861.

**HDMI-DVI connection**

This unit can be connected to a device that has a DVI terminal. Use an HDMI-DVI conversion cable for this connection and it requires audio cable for analog audio signal as well.

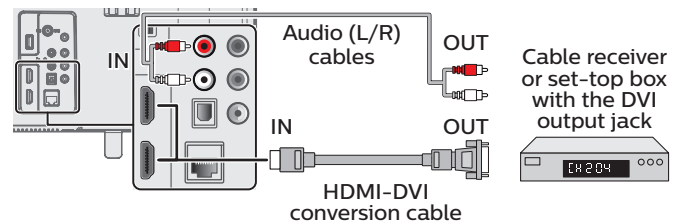
**Note(s)**

- Some HDMI cables and devices may not be compatible with the TV due to different HDMI specifications.
- Some newer HDMI devices may output signals that this TV cannot receive (such as 4K or HDR). For such devices you will need to change the output of that device to a compatible signal. Please consult with the manufacturer or the user manual of that device.
- Use an HDMI cable with the HDMI logo (a certified HDMI cable). High speed HDMI cable is recommended for the better compatibility.
- The unit accepts 480i, 480p, 720p, 1080i and 1080p video signals.
- HDMI-DVI connection requires separate audio connections as well and the audio signals are output as analog (L/R) audio.
- DVI does not display 480i image which is not in compliance with EIA/CEA-861/861B.

## HDMI-ARC connection

HDMI-ARC allows you to use EasyLink to output TV audio directly to a connected audio device, without the need for an additional digital audio cable.

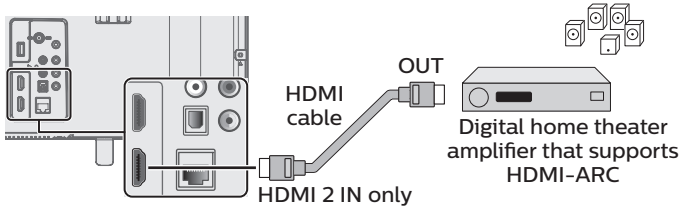

### Note(s)

- The HDMI 2 connector is HDMI Audio Return Channel (ARC) compliant. Use it to output digital audio to an HDMI home theater system.
- Be sure that the device is HDMI CEC and ARC compliant and that the TV is connected to the device using an HDMI cable attached to HDMI-ARC connectors.

## Composite analog video connection

Composite analog video connection offers standard picture quality for video devices connected to the unit.

If you connect to the unit's component / composite video (Y/VIDEO) input jack (green), connect audio cables to the audio (L/R) input jacks. When the audio is monaural, then only connect to the audio L input jack.

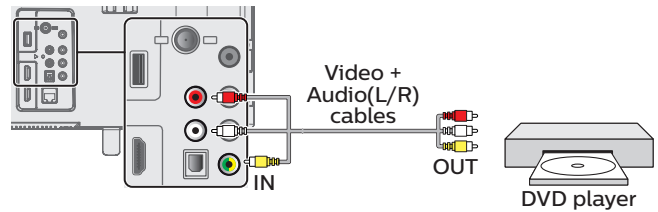

### Note(s)

- With this unit, yellow cable must be connected to Y (green) jack on the component video input jacks.
- Whenever you connect to the composite video input jack (Y/VIDEO), you must disconnect the component video input jacks (Pb and Pr). If you leave those jacks connected, it may cause an unstable picture.

## Component analog video connection

Component analog video connection offers better picture quality for video devices connected to the unit.

If you connect to the unit's component video (Y/Pb/Pr) input jacks, connect analog audio cables to the analog audio (L/R) input jacks.

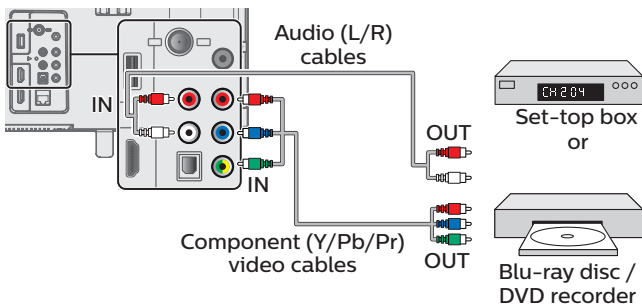

### Note(s)

- The unit accepts 480i, 480p, 720p, 1080i and 1080p of video signals for this connection.

## Connecting the TV to the internet using an Ethernet cable

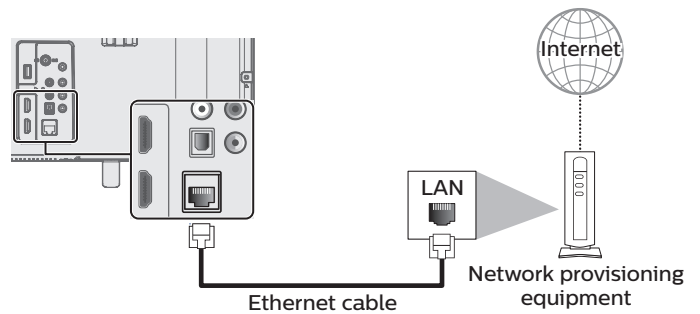

### Note(s)

- Please purchase shielded Ethernet cables at your local store and use them when you connect to network equipment.
- After connecting an Ethernet cable, set up necessary network settings. **Connect to network → p. 37**
- Do not insert any cable other than an Ethernet cable to the Ethernet port to avoid damaging the unit.
- If your telecommunications equipment (modem, etc.) does not have broadband router functions, connect a broadband router.
- If your telecommunications equipment (modem, etc.) has broadband router functions but there is no vacant port, then add a hub.
- For a broadband router, use a router which supports 10BASE-T / 100BASE-TX.
- Do not connect your PC directly to the Ethernet port of this unit.

## Connecting the TV to the internet using a wireless LAN

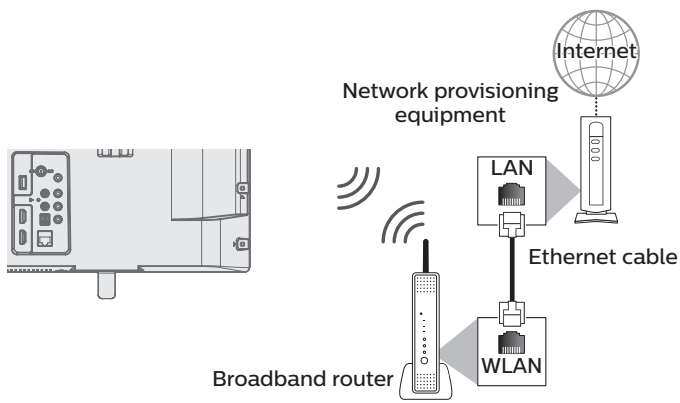

### Note(s)

- After you make the wireless connection, set up the necessary network settings. **Connect to network** → p. 37
- Use a wireless LAN Access Point (AP) (e.g. broadband wireless router) which supports IEEE 802.11 b/g/n. (n is recommended for stable operation of the wireless network)
- This unit does not support Ad-hoc mode.
- Other radio devices or obstacles may cause interference to the wireless network connection.

## Digital audio output connection

If you connect this unit to an external digital audio device, you can enjoy multi-channel audio like 5.1ch digital broadcasting sound.

Use a digital audio optical cable to connect the unit to external digital audio devices.

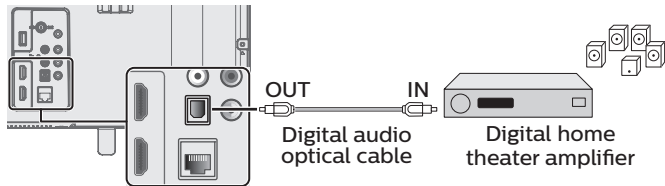

## PC connection

### HDMI connection

This unit can be connected to your PC that has an HDMI terminal. Use an HDMI cable for this digital connection.

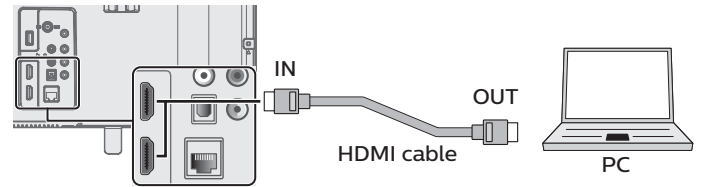

### HDMI-DVI connection

This unit can be connected to your PC that has a DVI terminal. Use an HDMI-DVI conversion cable for this video digital connection and it requires stereo mini 3.5mm plug audio cable for analog audio signal as well.

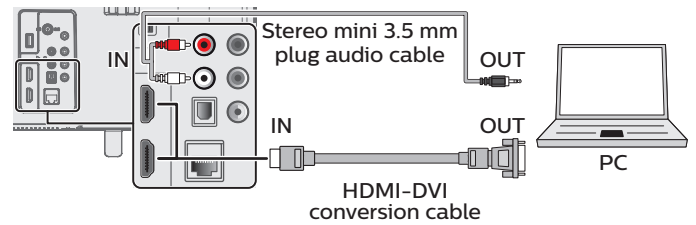

The following PC-input video signals can be displayed:

Format	Resolution	Refresh rate
VGA	640 x 480	60Hz
SVGA	800 x 600	
XGA	1,024 x 768	
WXGA	1,280 x 768	
	1,360 x 768	
FHD	1,920 x 1,080	24/30/60Hz

Other formats or non-standard signals will not be displayed correctly.

#### Note(s)

- Please purchase a HDMI-DVI conversion cable that has a ferrite core.
- The following operations may reduce noise.
  - Attach a ferrite core to the AC power cord of your PC.
  - Unplug the AC power cord and use the built-in battery of your portable / laptop PC.
- Some HDMI cables and devices may not be compatible with the TV due to different HDMI specifications.
- Use an HDMI cable with the HDMI logo (a certified HDMI cable). High speed HDMI cable is recommended for the better compatibility.
- The unit accepts 480i, 480p, 720p, 1080i and 1080p video signals only when using the HDMI connection and HDMI-DVI connection.
- HDMI-DVI connection requires separate audio connections as well and the audio signals are output as analog (L/R) audio.
- DVI does not display 480i image which is not in compliance with EIA/CEA-861/861B.

## USB memory stick

This unit offers easy playback of picture, music and video files.

Insert the USB memory stick into the USB terminal shown below.

For a complete list of file formats and specifications supported, refer to

**USB Section** → **p. 23**

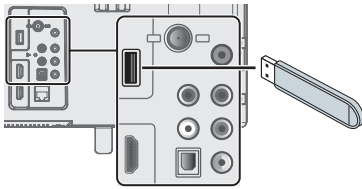

#### Note(s)

- The unit recognizes only a USB memory stick.
- Do not use a USB hub or an extension cable to connect an external hard disk drive to the unit. (Not supported.)
- Always insert a USB memory stick directly to this unit.
- A USB memory stick is not included with this unit.
- We do not guarantee that all USB memory sticks can be supported by this unit.
- Be sure to keep a backup copy of the original files on your USB device before you play them back on this unit. We have no responsibilities for damage or loss of your USB stored data.
- To protect your USB memory stick files from being erased place the write protect sliding tab in the protect position (if available).
- When you are ready to remove a USB memory stick, set the unit to go into standby mode to avoid any damage to your data and the unit.
- A USB memory stick that requires its own driver or the device with a special system such as fingerprint recognition are not supported.
- This unit is not allowed to use the USB memory stick which requires an external power supply (500mA or more).

*These operations are accessible by remote control.  
Some may also be accessible by the main unit's control panel.*

## Initial setup

This section will guide you through the unit's Initial setting which includes selecting a language for your on-screen menu, country, location and Autoprogram, which automatically scans and memorizes viewable channels. You can also set the network connection in this setting.

### Before you begin:

Make sure the unit is connected to an antenna or cable.

- After making all the necessary connections, press to turn on the unit.
  - It may take a few moments to turn on the unit for the first time.
  - Initial setup** menu appears automatically after the unit is turned on.
- Use to select the on-screen language, Voice guide, country, TV placement and location in the middle of the TV screen, then press **OK**.
  - You must set **Home** in location setting. Otherwise, **Picture** and **Sound** settings you adjusted will not be memorized after the unit goes into standby mode.
- Use to select **Skip** or **Next** on network setup screen.
- Use to select **Wireless** or **Wired**, then press **OK**.

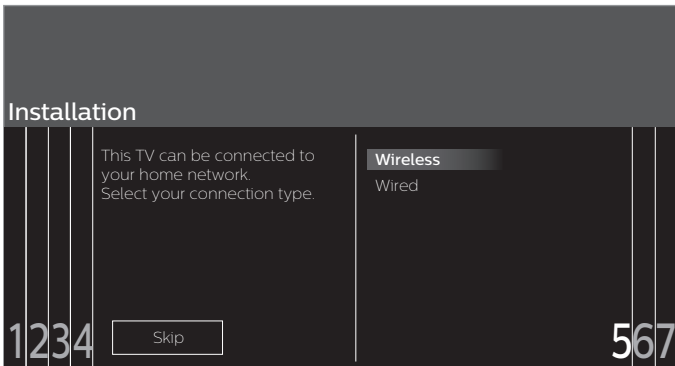

Wireless	If you have a wireless router, select <b>Wireless</b> to connect to the internet.
Wired	If you connect with an Ethernet cable, select <b>Wired</b> to connect to the internet.

- If you have a router with easy connect function, select **Wireless** and use to select **Easy Connect**, then press **OK**.
- When you select **On** in the selection screen for **Software update notification**, A message will appear later if there is the latest software on the network server.

- Use to select the signal type.

- If the TV is connected to a cable or satellite set-top box, select the 2nd one and skip to step 7.

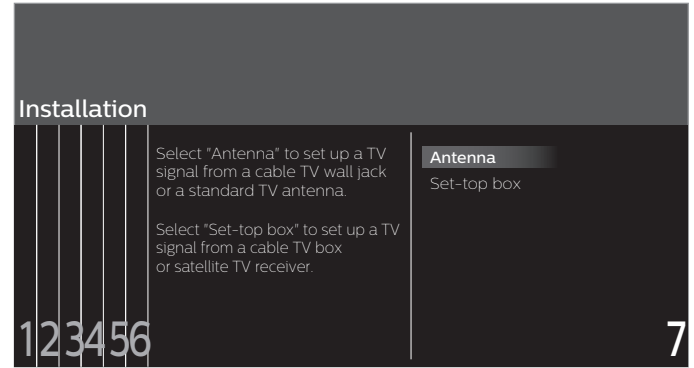

- Use to select **Antenna** for TV channels or **Cable** for CATV channels, then press **OK**.

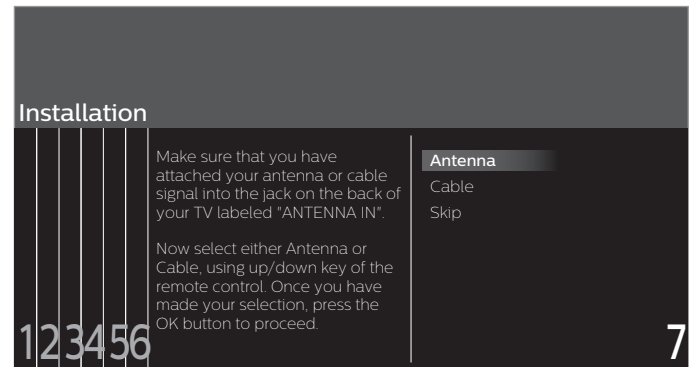

- When **Antenna** is selected, the TV detects antenna signals. It searches for DTV and analog TV channels available in your area.
- When **Cable** is selected, the TV detects signals supplied by cable. It searches for DTV, analog TV and cable channels available in your area.
- Auto programming will begin.

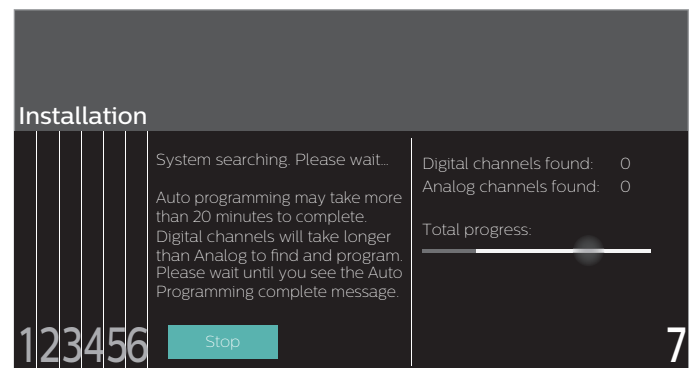



- 7 Use ▲▼ to select your preferred picture setting, then press **OK**.

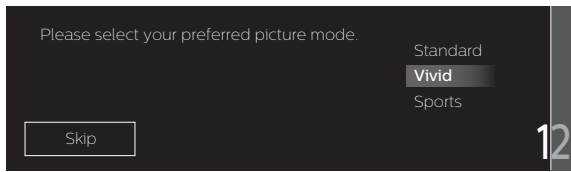

- 8 Use ▲▼ to select your preferred sound setting, then press **OK**.

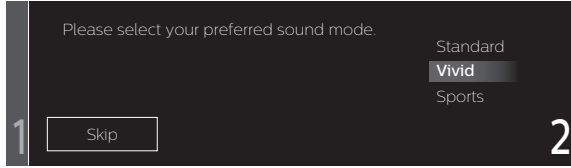

- 9 After **Picture and sound setup** is completed, a message will appear if there is the latest software on the network server.

#### ☰ Note(s)

- If you are not receiving a signal from your cable service, contact the cable provider.
- If you press **⏻** during Autoprogram, this setup of TV channels will be cancelled.
- The initial Autoprogram function can be executed for either **Antenna** or **Cable** only once. When you change the connection (Antenna / Cable), select **Search for channels** again. ➔ p. 34

#### **After an initial setup is completed...**

- If you want to scan the channels automatically again. **Search for channels** ➔ p. 34
- If you want to change to another language. **Language** ➔ p. 30
- If you want to change the country setting. **Country** ➔ p. 46
- If you want to change the location setting. **Location** ➔ p. 31
- If you want to change the network setting. **Connect to network** ➔ p. 37
- If you want to restore the picture and sound setting. **Picture and sound setup** ➔ p. 27

## 3 Use your TV

### Switching on your TV and putting it in standby mode

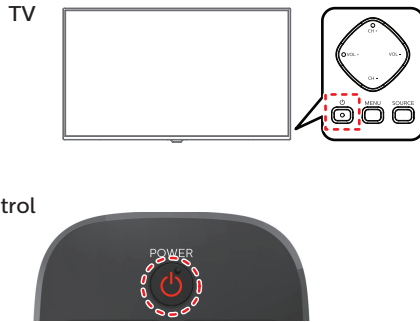

#### To turn the TV on from standby or off to standby

- Press on the TV or the remote control.

#### Note(s)

- Energy consumption contributes to air and water pollution. When the AC power cord is plugged in, your TV consumes energy with a very low standby power consumption.

### Adjusting volume

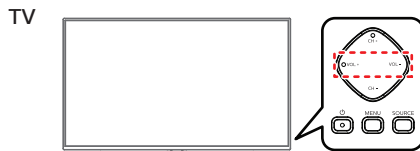

#### Remote control

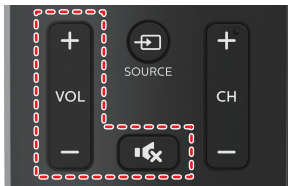

#### To decrease or increase volume

- Press **VOL + / -** on the TV or the remote control.

**VOL +** : Volume up

**VOL -** : Volume down

#### To mute or unmute sound

- Press on the remote control to mute the sound.
- Press again or **VOL + / -** to recover the original sound.

### Switching channels

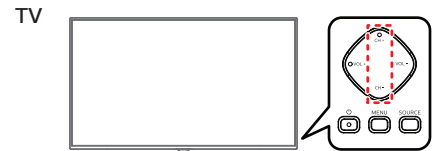

#### Remote control



#### To select channels by using CH + / -

- Press **CH + / -** on the TV or the remote control.

#### To select channels by using the NUMBER buttons

##### Digital TV operation

- For digital channels, press a number followed by a dot “.” and the corresponding sub channel number.

– When selecting digital channel 11.1

Be sure to press **.** before entering the subchannel number.



##### Cable / NTSC (Analog) TV operation

– When selecting cable or analog channel 11



Press **PREV.CH** to return to the previously viewed channel.

#### Note(s)

- To select the non-memorized channels, use **the NUMBER buttons**
- **Channel not available** or **No signal** will appear on the TV screen after the subchannel broadcast is over.
- **Audio only** message will appear on the TV screen, when you receive only sound signal.

## Watching channels from an external device

Switching each input mode can easily switch with the remote control between TV and external devices when they are connected to the unit.

- 1 Turn on the set-top box or the connected device.

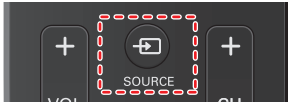

- 1 Press **SOURCE** and use **◀▶** to select the set-top box or the connected device and wait a few seconds till the picture appears.

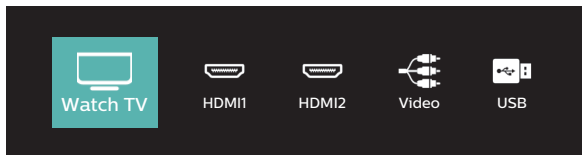

- 2 Use the remote control of the set-top box or the connected device to select channels.

## Access the Home menu

- 1 Press **HOME**.



## Guide to Home menu

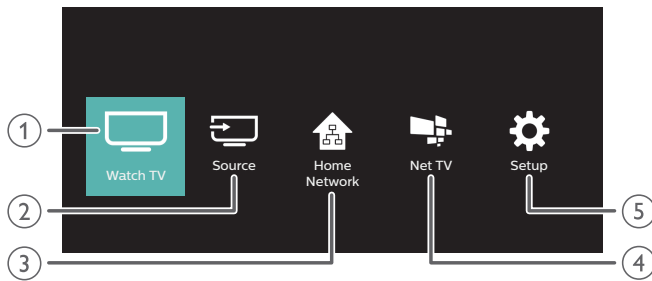

- 1 **Watch TV** : Switches back to the TV source if another source is selected.
- 2 **Source** : To select connected devices.
- 3 **Home Network** : Accesses Home network menus.
- 4 **Net TV** : Accesses Net TV menus.
- 5 **Setup** : Accesses menus that allow you to change picture, sound and other TV settings.

## Lock or unlock your device from the Home menu

This section describes how to lock or unlock specified device.

- 1 Press **SOURCE** on the remote control.
- 2 Use **◀▶** to select a device to lock or unlock.
- 3 Press **OPTIONS** on the remote control.
- 4 Use **▲▼** to select **Lock** or **Unlock**, then press **OK**.
  - If device lock is unlocked, **Lock** will be displayed. If device lock is locked, **Unlock** will be displayed at the top right of the device icons.
- 5 Enter your PIN. **Change PIN** → p. 36

## Changing device type

You can change device icons displayed in the source list.

- 1 Press **SOURCE** on the remote control.
- 2 Use **◀▶** to select the desired device.
- 3 Press **red** button on the remote control.
- 4 Use **▲▼** to select the desired type, then press **OK**.

### To reset the type

- Press **OPTIONS** on the remote control at step 3, then select **Original** icon.

## Scan connections

You can rescan TV connections and update the source list.

### Before you begin:

You must set **On** in **Master EasyLink**. → p. 32

- 1 Press **SOURCE** on the remote control.
- 2 Use **◀▶** to move the cursor to any device.
- 3 Press **OPTIONS** on the remote control.
- 4 Use **▲▼** to select **Scan connections**, then press **OK**.

## Create a list of favorite channels

You can create lists of your preferred TV channels so that you can find those channels easily.

- 1 Press **OK** while viewing a TV program.
- 2 Use **▲▼◀▶** to select the desired channel, then press **yellow** button.
- 3 Use **▲▼** to select the desired favorite list (**Favorites 1 – Favorites 4**), then press **OK** to add or remove on the list of favorite channels.
  - indicates that the channel is added.
  - indicates that the channel is removed.
  - The channel will be marked with **◆** icon.

## Display the list of favorite channels

- 1 Press **OK** while viewing a TV program.
- 2 Use **▲▼◀▶** to select **Favorites**.

### To change the favorite list

- 1 Press **blue** button.
- 2 Use **▲▼** to select the desired favorite list (**Favorites 1 – Favorites 4**).

### To remove a channel from the favorite list

- 1 Select the desired channel, then press **yellow** button.
- 2 Use **◀▶** to select **Yes**, then press **OK**.

## Changing Picture format

Display modes can be selected when your TV receives a 16:9 or 4:3 video signal.

Three types of display modes can be selected for a PC input signal.

Press **FORMAT** repeatedly to switch the TV aspect ratio.



### For 16:9 video signal

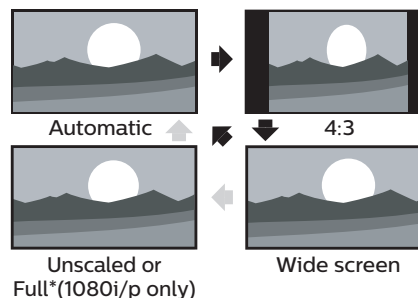

<b>Automatic</b>	Other than DTV and HDMI connected devices, enlarges the picture to best fit the screen. DTV and HDMI connected devices display the picture at its original size. The subtitles may remain visible.
<b>4:3</b>	Displays a 16:9 picture at a 4:3 size; the picture is shortened horizontally. Sidebars appear on both edges of the screen.
<b>Wide screen</b>	Displays a 16:9 picture that is stretched horizontally and vertically.
<b>Unscaled or Full* (1080i/p only)</b>	Displays a scaled 16:9 picture. Bars appear on both the upper and lower portions of the screen depending on the type of video signal.

\* This part differs depending on the product you have.

For 4:3 video signal

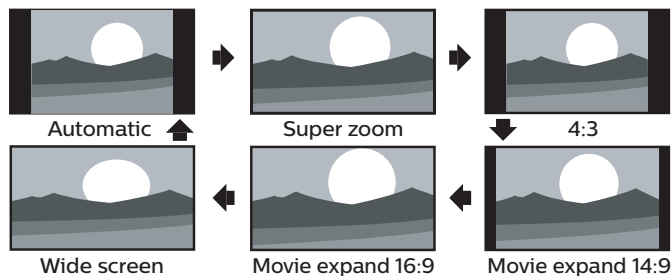

<b>Automatic</b>	Other than DTV and HDMI connected devices, enlarges the picture to best fit the screen. DTV and HDMI connected devices display the picture at its original size. The subtitles may remain visible.
<b>Super zoom</b>	Displays a 4:3 picture at a 16:9 size; the picture is stretched horizontally and vertically and its left and right edges are enlarged. This crops out some of the top and bottom of the picture.
<b>4:3</b>	Displays a 4:3 picture at its original size. Sidebars appear on both edges of the screen.
<b>Movie expand 14:9</b>	Displays a 4:3 picture at a 14:9 size; the picture is stretched horizontally and vertically. This crops out some of the top and bottom of the picture. Sidebars appear on both edges of the screen.
<b>Movie expand 16:9</b>	Displays a 4:3 picture at a 16:9 size; the picture is stretched horizontally and vertically. This crops out some of the top and bottom of the picture.
<b>Wide screen</b>	Displays a picture that is stretched out of proportion to fill the screen.

For PC input signal

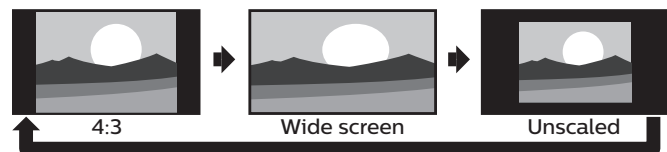

- This unit can also be connected to your PC that has a DVI terminal. Use an HDMI-DVI conversion cable for this video connection and it requires stereo mini 3.5mm plug audio cable for analog audio signal as well.
- Refer to 16:9 video signal on this page if the PC has HDMI output.

<b>4:3</b>	Displays a proportionately stretched picture. Sidebars appear on both edges of the screen.
<b>Wide screen</b>	Displays a picture that is stretched out of proportion to fill the screen.
<b>Unscaled</b>	Displays a picture in its original size.

If the signal source has side or top-bottom bars inserted into the picture, the Picture format function will not eliminate them.

TV screen information

You can display the currently selected channel or other information such as the aspect ratio on the TV screen.

In the digital mode, the detailed broadcasting information for the current off-the-air channel such as program title and program guides are displayed.

1 Press **INFO**.

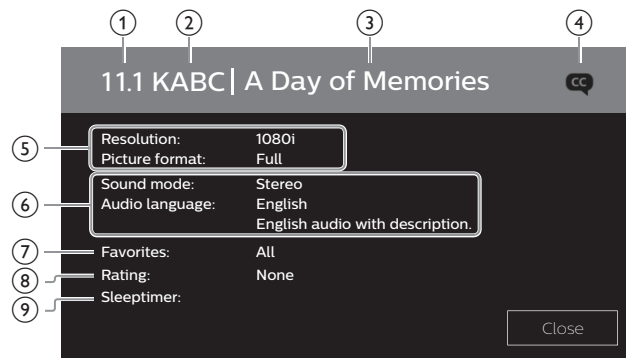

- ① Channel number / Input mode  
**Switching channels** → p. 18  
**Watching channels from an external device** → p. 19
- ② Broadcast station
- ③ Program title (for DTV only)
- ④ CC (not available if Closed caption is set to Off)  
**Caption settings** → p. 33
- ⑤ Program's image aspect ratio  
**Changing Picture format** → p. 20
- ⑥ Audio language (DTV) / Audio mode (Analog TV)  
**Sound** → p. 29
- ⑦ Favorites  
**Create a list of favorite channels** → p. 20
- ⑧ Child lock rating  
**Child lock** → p. 35
- ⑨ Remaining time on sleep timer  
**Sleptimer** → p. 30

2 Press **INFO** to hide the information.

**Note(s)**

- While the program guide is displayed, the closed caption function is interrupted.
- The information display will automatically disappear in 5 seconds.

## Using options menu

You can access to some TV settings directly by using **OPTIONS**.

- 1 Press **OPTIONS** to display options menu, then press **OK**.



- 2 Use **▲▼◀▶** to select a desired setting, then press **OK**.

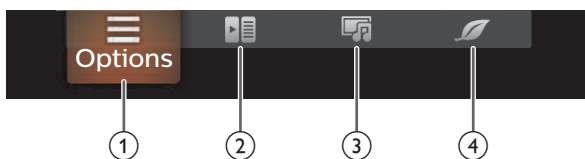

### ① Options

Following settings can be configured.

<b>Voice guide toggle</b>	To set Voice guide on or off. <b>Voice guide toggle</b> ➡ p. 32
<b>Closed captions</b>	To choose the Closed captions display setting. <b>Closed captions</b> ➡ p. 33
<b>Digital audio language</b>	To Select the language according to your preference. (It differs depending on the program.) <b>Digital audio language</b> ➡ p. 36
<b>Mono/Stereo</b>	To Select an audio format. <b>Mono/Stereo</b> ➡ p. 36

### ② Controls

If you have our brand products such as Blu-ray disc player or DVD recorder that are compatible with EasyLink functions, connect them to this unit via an HDMI cable so you can simply operate various items from this unit's remote control.

**Before you begin:**

select a device connected to an HDMI connection. ➡ p. 19

You must set **On** in **Master EasyLink**. ➡ p. 32

Otherwise, LINK does not work even if you connected our brand devices to this unit.

- 1 Press **OPTIONS** to display options menu.

- 2 Use **◀▶** to select **Controls** then press **OK**.

- 3 Use **▲▼** to select the desired item, then press **OK**.

<b>Device-menu</b>	Controls the menu of your connected EasyLink device.
<b>Device-contents</b>	Controls the top menu of your DVD or Blu-ray discs.
<b>Device-favorite</b>	Controls the pop-up menu of your Blu-ray discs.

### ☰ Note(s)

- Some of EasyLink functions may not be available depending on your EasyLink devices or discs.
- You must connect this unit to our brand EasyLink devices and be sure its EasyLink (HDMI CEC) setting is also set to On.
- We do not guarantee 100% interoperability with other brands of HDMI link compliant devices.

### ③ Picture and sound

Following settings can be configured.

<b>Auto picture</b>	To set predefined picture mode. <b>Picture</b> ➡ p. 27
<b>Auto sound</b>	To set predefined sound mode. <b>Sound</b> ➡ p. 29
<b>Headphone volume</b>	To adjust headphone volume. <b>Sound</b> ➡ p. 29
<b>TV speakers</b>	To Select the audio output from the unit's speakers or not. <b>Sound</b> ➡ p. 29
<b>Picture format</b>	To switch the TV aspect ratio. <b>Changing Picture format</b> ➡ p. 20
<b>Setup</b>	To display setup menu.

### ④ ECO settings

Following settings can be configured.

<b>Switch off timer</b>	<p>You can turn off the unit automatically when there is no operation for specified time. In spite of this setting, the unit goes into standby mode automatically if there is no signal input and no user operation for 15 minutes.</p> <p>Press <b>▲</b> repeatedly to change the amount of time (increases the time by 30 minutes up to 240 minutes).</p> <p>Each press of <b>▼</b> will decrease the time by 30 minutes.</p> <p>To cancel the timer, press <b>▼</b> repeatedly until "0" is displayed.</p>
-------------------------	---

## USB

Your TV is fitted with a USB connection that enables you to view photos, listen to music or watch video files stored on a USB memory stick.

- 1 Press **SOURCE** and use **◀▶** to select **USB**, then press **OK**.
- 2 Use **▲▼◀▶** to select the desired file, then press **OK**.

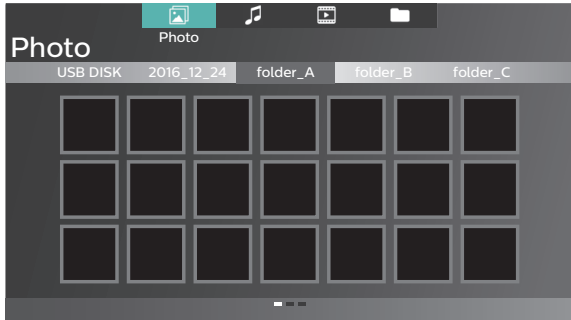

- These recorded files must meet specifications shown below:

Picture (JPEG / Progressive JPEG)		
JPEG	Upper limit	4000x4000 pixels
Progressive JPEG	Upper limit	1024x768 pixels

Music (MP3 / WAV / AAC)		
MP3	Sampling frequency	32 kHz or 44.1 kHz or 48 kHz
	Constant bit rate	32 kbps - 320 kbps
WAV	Sampling frequency	8 kHz - 48 kHz
	Constant bit rate	64 kbps - 1.5 Mbps
AAC	Sampling frequency	8 kHz - 48 kHz
	Constant bit rate	-

Video (MPEG / VOB / AVI / MP4)						
Maximum video	H.264, H.265/HEVC, MPEG: 1920x1080@60fps					
Extension	.avi	.mpg, .mpeg	.ts, .trp, .tp	.vob	.mp4	.mkv
Video codec	MPEG1, MPEG2, MPEG4, H.264	MPEG1, MPEG2, MPEG4	MPEG1, MPEG2, H.264, H.265/ HEVC	MPEG1, MPEG2	MPEG1, MPEG2, MPEG4, H.264, H.265/ HEVC	MPEG1, MPEG2, MPEG4, H.264, H.265/ HEVC
Audio codec						
Dolby Digital	YES	YES	YES	YES	YES	YES
MPEG1/2 audio layer1/2/3	YES	YES	YES	YES	NO	YES
LPCM	YES	YES	YES	YES	YES	YES
AAC-LC	YES	YES	YES	YES	YES	YES

## Note(s)

- This unit accepts USB memory stick only. Other storage devices such as external HDD by USB bus power will not work.
- Do not use an extension cord and/or USB hub to connect devices to this unit. Always directly insert the USB flash memory stick to this unit directly.
- We cannot be held responsible if your USB memory stick is not supported, nor will we accept any liability for damage or loss of stored data.
- The USB memory stick is not included with this TV.
- A maximum of 1,023 folders or files can be recognized.
- A file name exceeding 256 characters or contains a dot character is not supported on this TV.
- A USB memory stick that required its own driver or the device with a special system such as fingerprint recognition are not supported.
- Be sure to keep a backup copy of the original files on your USB device before you play them back on this unit. We have no responsibilities for damage or loss of your USB stored data.
- To avoid damaging the USB memory stick and the unit always turn off the unit before you remove the USB memory stick.
- This unit is not allowed to use the USB memory stick which requires external power supply (500 mA or more).
- This unit does not support MTP (Media Transfer Protocol) or the file other than FAT16 and FAT32 file system. If the file is not supported, an error message appears.
- When the unit does not recognize the USB memory stick, try reconnecting it.
- Playing the files recorded with high bit rates, the images can be interrupted in some occasions.
- This unit does not support external subtitles.
- This unit cannot play back a file which goes over the limit of file restriction limit.

## Viewing photos

- Use ◀▶ to select **Photo**, then press **OK**.
- Use ◀▶ to select the desired item, then press **OK**.
- Press **OK** or ▶|| to start a slide show of the files.
  - Press **OK** or ▶|| to pause the slide show.
  - The || icon appears.
  - Press ◀◀ or ▶▶ to move between images.
  - Press ↵ **BACK** or ■ to stop the slide show.
  - Press □ **OPTIONS** to display the optional menu, then use ▲▼ to select the desired item.

Voice guide toggle *1	Off	Sets Voice guide to off.
	On	Sets Voice guide to on.
Repeat *2	Off	Sets repeat playback to off.
	One	Sets repeat playback for a selected image file.
	All	Sets repeat playback for all image files in the current folder.
Slide time *2	Short	Switches to the next image in 5 seconds.
	Medium	Switches to the next image in 10 seconds.
	Long	Switches to the next image in 15 seconds.
Transitions *2	None	No effect when switching images.
	Dissolve	Overlaps the next image on the current image.
	Wipe right	Pushes the current image out from left.
	Wipe left	Pushes the current image out from right.
	Wipe up	Pushes the current image out from bottom.
	Wipe down	Pushes the current image out from top.
	Box in	The next image comes to the center from the outside.
	Box out	The next image goes to the outside from the center.
Auto picture *2	Selects the picture mode according to your preference. (Standard, Natural, Vivid, Sports, Movie, Game, Energy saving and Internet video)	
Rotate *3	0	Displays an image in its original direction.
	90	Rotates an image 90 degrees clockwise.
	180	Rotates an image 180 degrees clockwise.
	270	Rotates an image 270 degrees clockwise.
Zoom *3	1X	Displays an image in its original size.
	2X	Magnifies a current image by 2 times.
	4X	Magnifies a current image by 4 times.

- \*1 Voice guide toggle is available in slide show and pause mode.
- \*2 You can set **Repeat**, **Slide time**, **Transitions** and **Auto picture** when images are in slide show.
- \*3 You can set **Rotate** and **Zoom** when slide show is in pause mode.

## Playing music

- Use ◀▶ to select **Music**, then press **OK**.
- Use ◀▶ to select the desired item, then press **OK**.
- Press **OK** or ▶|| to play the selected files.
  - Press **OK** or ▶|| to pause, then press **OK** or ▶|| again to resume.
  - Press ▶▶ to fast-forward search.
  - Press ◀◀ to fast-backward search.
  - Press ■ to stop playback.
  - Press □ **OPTIONS** to display the optional menu, then use ▲▼ to select the desired item.

Voice guide toggle *	Off	Sets Voice guide to off.
	On	Sets Voice guide to on.
Repeat	Off	Sets repeat playback to off.
	One	Sets repeat playback for a selected music file.
	All	Sets repeat playback for all music files in the current folder.
Shuffle	Off	Sets shuffle playback to Off.
	On	Sets shuffle playback for all music files in the current folder.
TV Speakers	Off	The sound will not be output from the unit's speakers.
	On	The sound will be output from the unit's speakers.
	Speakers EasyLink	You can control audio output from your connected EasyLink compliant devices with <b>VOL + / -</b> by using this unit's remote control.
Auto sound	Selects the sound mode according to your preference. (Standard, Vivid, Sports, Movie, Music and News)	

\* Voice guide toggle is available in slide show and pause mode.



## Playing movies

- 1 Use ◀▶ to select **Movie**, then press **OK**.
- 2 Use ◀▶ to select the desired item, then press **OK**.
- 3 Press **OK** or ▶|| to play the selected files.
  - Press **OK** or ▶|| to pause, then press **OK** or ▶|| again to resume.
  - Press ▶▶ to fast-forward search.
  - Press ◀◀ to fast-backward search.
  - Press ■ to stop playback.
    - Press ▶|| to resume from the point at which playback was stopped.
    - Press **OK** to play from the beginning of the file.
  - Press  **OPTIONS** to display the optional menu, then use ▲▼ to select the desired item.

Voice guide toggle *	Off	Sets Voice guide to off.
	On	Sets Voice guide to on.
Repeat	Off	Sets repeat playback to off.
	One	Sets repeat playback for a selected video file.
	All	Sets repeat playback for all video files in the current folder.
TV speakers	Off	The sound will not be output from the unit's speakers.
	On	The sound will be output from the unit's speakers.
	Speakers EasyLink	You can control audio output from your connected EasyLink compliant devices with VOL + / – by using this unit's remote control.
Auto picture	Selects the picture mode according to your preference. (Standard, Natural, Vivid, Sports, Movie, Game, Energy saving and Internet video)	
Auto sound	Selects the sound mode according to your preference. (Standard, Vivid, Sports, Movie, Music and News)	

\* Voice guide toggle is available in slide show and pause mode.

### Note(s)

- The resume information will be kept even when the unit is Turned off.
- If you play another file while the previously viewed file is being resumed, the resume information of the previously viewed file will be deleted.
- The file or the folder in resume stop mode will be highlighted in gray on **List** or **Thumbnails**.

# 4 Getting more from your TV

This section describes the overview of the **Setup** menu displayed when you press **Home** and use **Left/Right** to Select **Setup**. The **Setup** menu consists of the function setting items below.

- 1 Press **Home** to display the Home menu.

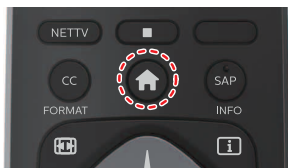

- 2 Use **Left/Right** to select **Setup**, then press **OK**.

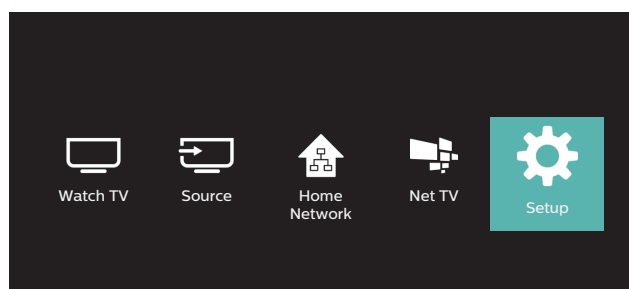

- 3 Use **Up/Down/Left/Right** to select the desired menu and an item, then press **OK**.

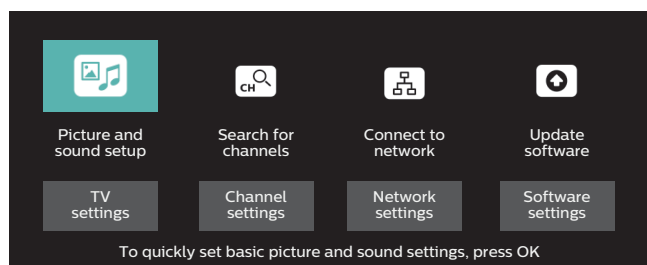

## Picture and sound setup ➔ p. 27

Guides you to get the best picture and sound settings.

## TV settings ➔ p. 27

Accesses menus that allow you to change picture, sound and TV usage settings.

## Search for channels ➔ p. 34

Guides you through channel installation.

## Channel settings ➔ p. 34

Accesses menus that allow you to change channel settings.

## Connect to network ➔ p. 37

Guides you through network installation.

## Network settings ➔ p. 38

Accesses menus that allow you to network settings.

## Update software ➔ p. 42

Guides you through an update of the TV software.

## Software settings ➔ p. 43

Accesses menus that allow you to change software settings.

# Picture and sound setup

**Before you begin:**

You must set **Home** in **Location**. ➡ p. 31

Otherwise, personalized picture and sound settings will not be memorized after the unit goes into standby mode.

- 1 Press **Home** and use **Left/Right** to select **Setup** then press **OK**.
- 2 Use **Up/Down/Left/Right** to select **Picture and sound setup**, then press **OK**.
- 3 Follow steps 7 to 8 in **Initial setup** ➡ p. 17

## TV settings

### Picture

**Before you begin:**

You must set **Home** in **Location**. ➡ p. 31

Otherwise, personalized picture and sound settings will not be memorized after the unit goes into standby mode.

- 1 Press **Home** and use **Left/Right** to select **Setup** then press **OK**.
- 2 Use **Up/Down/Left/Right** to select **TV settings**, then press **OK**.
- 3 Use **Up/Down** to select **Picture**, then press **OK**.

<b>Picture</b>	Auto picture
Sound	Backlight
Features	Contrast
Installation	Brightness
Accessibility	Color
	Tint
	Sharpness
	Pixel Plus HD
	Advanced settings
	Picture format
	Mode selection
	Horizontal position
	Vertical position

- 4 Use **Up/Down/Left/Right** to select the item you want to adjust, then press **OK**.

The following picture settings can be configured. Depending on the format of the picture source, some picture settings are not available.

Auto picture	To set your TV to a predefined picture setting.	
	<b>Personal</b>	The customized settings you defined using the <b>Picture</b> menu.
	<b>Standard</b>	For normal TV viewing.
	<b>Natural</b>	Ideal picture mode for viewing high quality content without any picture enhancements.
	<b>Vivid</b>	Enhanced picture contrast and sharpness for viewing in a well-lit room.
	<b>Sports</b>	Brilliant picture settings for high action.
	<b>Movie</b>	Deep picture settings for a cinematic experience.
	<b>Game</b>	Optimized for PCs and game consoles.
	<b>Energy saving</b>	Eco TV settings for low power consumption.
<b>Internet video</b>	Optimized for low bit-rate internet video.	

When you adjust the following settings, **Personal** picture will be set automatically.

	Cursor ▼	Cursor ▲
<b>Backlight</b>	To reduce power consumption and brightness	To increase power consumption and brightness
<b>Contrast</b>	To decrease contrast	To increase contrast
<b>Brightness</b>	To decrease brightness	To increase brightness
<b>Color</b>	To decrease color intensity	To increase color intensity
<b>Tint</b>	To add green	To add red
<b>Sharpness</b>	To soften	To sharpen
<b>Pixel Plus HD</b>	Enters sub-menus to adjust the following settings: (Dynamic contrast, Color enhancement, Black stretch, 120 PMR, Macro Dimming, Noise reduction and MPEG artifact reduction)	
<b>Advanced settings</b>	Enters sub-menus to adjust the following settings: (Color alignment, Custom color management, Gamma and Film mode)	
<b>Picture format</b>	Automatic	Changing Picture format ➡ p. 20
	Super zoom	
	4:3	
	Movie expand 14:9	
	Movie expand 16:9	
	Wide screen	
	Full	
<b>Mode selection</b>	Unscaled	To turn off image enhancement features which makes the TV to act purely as a monitor
	PC	
<b>Mode selection</b>	HDTV	To enable image enhancement features to improve picture quality
	Cursor ▼	Cursor ▲
<b>Horizontal position</b>	To move PC screen left	To move PC screen right
<b>Vertical position</b>	To move PC screen down	To move PC screen up

You may adjust picture quality and enhancement settings using **Pixel Plus HD** and **Advanced settings** sub menus.

Auto picture	<b>Dynamic contrast</b>	Off
Backlight	Color enhancement	Minimum
Contrast	Black stretch	Medium
Brightness	120 PMR	Maximum
Color	Macro Dimming	
Tint	Noise reduction	
Sharpness	MPEG artifact reduction	
<b>Pixel Plus HD</b>		
Advanced settings		
Picture format		
Mode selection		
Horizontal position		
Vertical position		

<b>Dynamic contrast</b>	To select the desired setting, then press <b>OK</b> (Off, Minimum, Medium and Maximum)	
<b>Color enhancement</b>	<b>Off</b>	To set color enhancement to off
	<b>On</b>	To make colors more vivid and bright
<b>Black stretch</b>	To select the desired setting, then press <b>OK</b> (Off, Minimum, Medium and Maximum)	
<b>120 PMR</b>	<b>Off</b>	To set <b>120 PMR</b> to <b>Off</b>
	<b>On</b>	To make the video appear smoother
<b>Macro Dimming</b>	To select the desired setting, then press <b>OK</b> (Off, Minimum, Medium and Maximum)	
<b>Noise reduction</b>	To select the desired setting, then press <b>OK</b> (Off, Minimum, Medium and Maximum)	
<b>MPEG artifact reduction</b>	To select the desired setting, then press <b>OK</b> (Off, Minimum, Medium and Maximum)	

Auto picture	<b>Color alignment</b>	Mode
Backlight	Custom color management	Red gain
Contrast	Gamma	Green gain
Brightness	Film mode	Blue gain
Color		Red offset
Tint		Green offset
Sharpness		Blue offset
Pixel Plus HD		
<b>Advanced settings</b>		
Picture format		
Mode selection		
Horizontal position		
Vertical position		

<b>Color alignment</b>	<b>Mode</b>	To set the color temperature to <b>Personal, Cool, Normal</b> and <b>Warm</b> . When you adjust the following settings, <b>Personal</b> will be set automatically.	
		<b>Cursor ▼</b>	<b>Cursor ▲</b>
	<b>Red gain</b>	To decrease red contrast	To increase red contrast
	<b>Green gain</b>	To decrease green contrast	To increase green contrast
	<b>Blue gain</b>	To decrease blue contrast	To increase blue contrast
	<b>Red offset</b>	To decrease red brightness	To increase red brightness
	<b>Green offset</b>	To decrease green brightness	To increase green brightness
	<b>Blue offset</b>	To decrease blue brightness	To increase blue brightness
	<b>Custom color management</b>	To select the desired setting, then press <b>OK</b> (Red, Yellow, Green, Cyan, Blue and Magenta)	
		<b>Cursor ▼</b>	<b>Cursor ▲</b>
<b>Tint</b>		To rotate only selected color tint in clockwise direction	To rotate only selected color tint in counterclockwise direction
<b>Saturation</b>		To decrease color with only selected color	To increase color with only selected color
	<b>Brightness</b>	To decrease brightness with only selected color	To increase brightness with only selected color
<b>Gamma</b>	To select the desired setting, then press <b>OK</b> (Very Dark Room, Dark Room, Normal, Bright Room and Very Bright Room)		
<b>Film mode</b>	<b>Off</b>	To set film mode to off	
	<b>Auto</b>	To optimize the picture recorded by the original film	

#### Note(s)

- **Mode selection** is available only if
  - The external input modes are selected HDMI 1 or HDMI 2.
  - The connected HDMI device is outputting a video signal.

# Sound

## Before you begin:

You must set **Home** in **Location**. ➔ p. 31

Otherwise, personalized picture and sound settings will not be memorized after the unit goes into standby mode.

- 1 Press **⬆** and use **⬅➡** to select **Setup** then press **OK**.
- 2 Use **▲▼⬅➡** to select **TV settings**, then press **OK**.
- 3 Use **▲▼** to select **Sound**, then press **OK**.

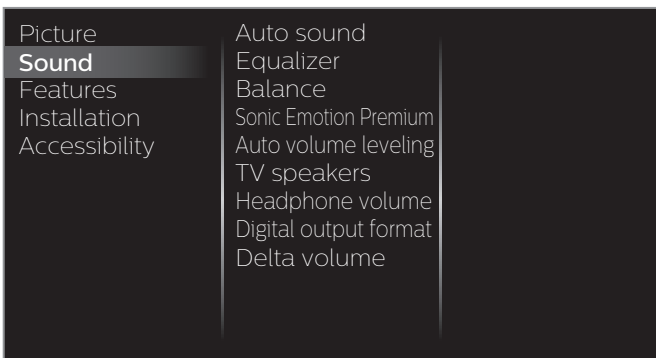

- 4 Use **▲▼⬅➡** to select the item you want to adjust, then press **OK**.

The following sound settings can be configured. Depending on the format of the broadcasting, some sound settings are not available.

Auto sound	To set your TV to a predefined sound setting. When you adjust the following settings ( <b>Equalizer</b> , <b>Sonic Emotion Premium</b> and <b>Auto volume leveling</b> ), <b>Personal</b> sound will be set automatically.	
	Personal	The customized settings you defined using the <b>Sound</b> menu.
	Standard	For normal TV viewing.
	Vivid	Enhanced sound.
	Sports	Clear sound for high action.
	Movie	Powerful sound settings for a cinematic experience.
	Music	Optimized for music playback.
	News	Set the anchor's voice at a comfortable volume.

Adjust the tonal quality for each frequency.

Equalizer	Cursor ▲	Cursor ▼
	To adjust each level of tonal quality Press <b>⏪</b> <b>BACK</b> to go back to the previous menu.	

Adjust the speakers to suit your listening preference.

Balance	Cursor ▲	Cursor ▼
	To adjust the balance of the right and left speakers	

This selects sound modes for more spatial or surround sound reproduction.

Sonic Emotion Premium	Sonic Emotion	Off	To set Sonic Emotion to off
		On	To set Sonic Emotion to on
	Dialog Enhancement	Off	To set Dialog Enhancement to off
		On	To set Dialog Enhancement to on
	Bass Enhancement	Off	To set Bass Enhancement to off
		On	To set Bass Enhancement to on
	Absolute 3D Sound	Off	To set Absolute 3D Sound to off
		On	To set Absolute 3D Sound to on

This function keeps a constant Loudness differential between the TV commercials and the programs.

Auto volume leveling	Off	To remove the Auto volume leveling
	On	To reduce volume differences between the TV commercials and the programs

You can select the audio output from the unit's speakers or not. If your amplifier is HDMI link function compatible and connected by an HDMI cable to this unit, some sound operations such as volume up can be changed by using this unit's remote control. Make sure **Master EasyLink** is set to **On**. ➔ p. 31

TV speakers	Off	No output sound from the unit's speakers
	On	To output sound from the unit's speakers
	Speakers EasyLink	To control audio output from your connected EasyLink compliant devices with <b>VOL + / -</b> by using this unit's remote control.

Adjust headphone volume.

Headphone volume	Cursor ▲	Cursor ▼
	To decrease or increase volume	

You can set the digital audio output format from SPDIF/ARC.

Digital output format	PCM	To output PCM format
	Bitstream	To output audio in its native format as Bitstream to connected audio receiver

If a channel or input device is too loud or too soft, navigate to that channel or input device.

Delta volume	Cursor ▲	Cursor ▼
	Provides the ability to set a custom volume level for the current channel or input source. If the source volume is too loud, set a negative value (-1 to -12) If the source volume is too soft, set a positive value (+1 to +12)	

## Features

- 1 Press **Home** and use **Left/Right** to select **Setup** then press **OK**.
- 2 Use **Up/Down/Left/Right** to select **TV settings**, then press **OK**.
- 3 Use **Up/Down** to select **Features**, then press **OK**.

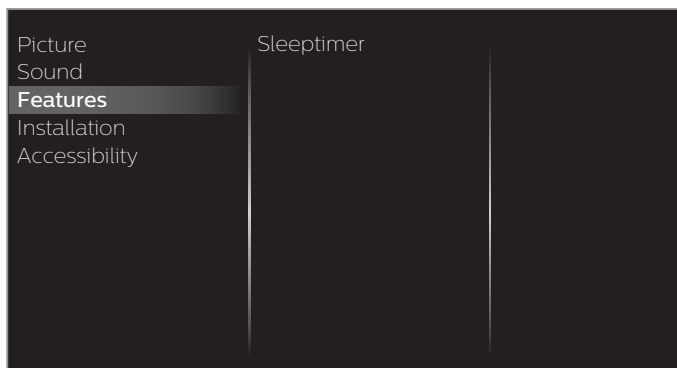

- 4 Adjust the following items.

## Sleeptimer

Sleep timer can set the unit to go into standby mode after an incremental period of time.

- 1 Use **Up/Down** to select **Sleeptimer**, then press **OK**.
- 2 Use **Up** repeatedly to change the amount of time (increases the time by 5 minutes up to 180 minutes).
  - Each press of **Down** will decrease the time by 5 minutes.
  - Press **INFO** once to call up the display for checking the remaining time.
  - To cancel the sleep timer, press **Up/Down** repeatedly until "0" is displayed.

## Installation

- 1 Press **Home** and use **Left/Right** to select **Setup** then press **OK**.
- 2 Use **Up/Down/Left/Right** to select **TV settings**, then press **OK**.
- 3 Use **Up/Down** to select **Installation**, then press **OK**.

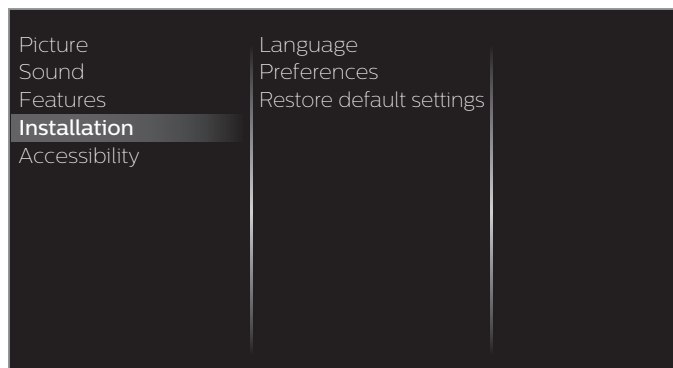

- 4 Adjust the following items.

## Language

You can set the language for the on-screen display.

- 1 Use **Up/Down** to select **Language**, then press **OK**.

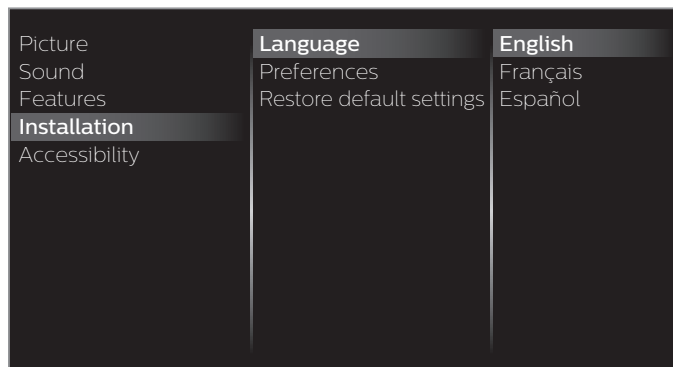

- 2 Use **Up/Down** to select **English**, **Español** or **Français**, then press **OK**.

**Note(s)**

- If you need the English menu instead of the Spanish or French menu's, press **Home**.  
 Use **Left/Right** to select **Configuración** or **Configuration**, then press **OK**.  
 Use **Up/Down/Left/Right** to select **Ajustes de TV** or **Réglages de la télévision**, then press **OK**.  
 Use **Up/Down** to select **Instalación** or **Installation**, then press **OK**.  
 Use **Up/Down** to select **Idioma** or **Langue**, then press **OK**.  
 Use **Up/Down** to select **English**, then press **OK**.  
 Press **Home** to exit the Home menu.

## Preferences

You can set the unit to reduce the power consumption or adjust the backlight brightness in **Location** setting.

**EasyLink** allows you to operate your connected EasyLink device.

### Setting your location to home

Choosing **Home** gives you full flexibility to change predefined settings for picture and sound.

- 1 Use ▲▼ to select **Preferences**, then press **OK**.
- 2 Use ▲▼ to select **Location**, then press **OK**.

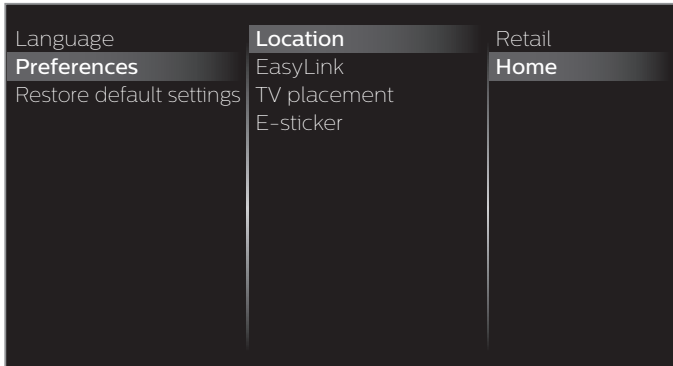

- 3 Use ▲▼ to select **Home**, then press **OK**.

<b>Retail</b>	The unit will be set up with predefined settings for retail displays. In this setting, you can set the backlight brighter.
<b>Home</b>	The unit is set to maximize the energy efficiency for home setting and it can be adjusted through a choice of picture and sound quality selections according to your preference.

#### Note(s)

- You must set **Home** in the menu. Otherwise, personalized picture and sound settings will not be memorized after the unit goes into standby mode.

### TV placement

To apply the best settings for your TV, select wall mount or stand mount.

- 1 Use ▲▼ to select **Preferences**, then press **OK**.
- 2 Use ▲▼ to select **TV placement**, then press **OK**.
- 3 Use ▲▼ to select **Wall mounted** or **On a TV stand**, then press **OK**.

### E-sticker

When you set **Location** to **Retail**, E-sticker (Electronic Sticker) is displayed. E-sticker can be turned off using procedure below.

- 1 Use ▲▼ to select **Preferences**, then press **OK**.
- 2 Use ▲▼ to select **E-sticker**, then press **OK**.
- 3 Use ▲▼ to select **Off**, then press **OK**.

## Use Philips EasyLink

Your TV supports Philips EasyLink, which enables one-touch play and one-touch standby between EasyLink-compliant devices. Compliant devices must be connected via an HDMI connector.

### One-touch play

When you connect your TV to devices that support one-touch play, you can control your TV and the devices with one remote control. For example, when you press ► (**Play**) on your DVD remote control, your TV automatically switches to the correct channel to show the DVD content.

### One-touch standby

When you connect your TV to devices that support standby, you can use your TV remote control to put your TV and all connected HDMI devices in standby mode. You can perform one-touch standby using the remote control from any of the connected HDMI devices.

### System audio control

When you connect your TV to HDMI CEC compliant devices, your TV can switch automatically to play audio from the connected device. To use one-touch audio, you must map the audio input from the connected device to your TV. You can use the remote control from the connected device to adjust the volume.

### Remote control (RC) key forwarding

RC key forwarding allows you to control EasyLink-compliant devices using your TV remote control.

### HDMI-ARC (Audio Return Channel) (HDMI 2 only)

HDMI-ARC allows you to use Philips EasyLink to output TV audio directly to a connected audio device, without the need for an additional digital audio cable. Be sure that the device is HDMI CEC and ARC compliant, and that the TV is connected to the device using an HDMI cable attached to both HDMI-ARC connectors.

#### Note(s)

- Philips does not guarantee 100% interoperability with all HDMI CEC devices.
- The EasyLink-compliant device must be switched on and selected as the source.

### EasyLink (HDMI CEC)

This function allows you to operate the linked functions between our brand devices with a EasyLink feature and this unit connecting through an HDMI cable. You must connect this unit to our brand EasyLink devices and be sure its EasyLink (HDMI CEC) setting is also set to on.

- 1 Use ▲▼ to select **Preferences**, then press **OK**.
- 2 Use ▲▼ to select **EasyLink**, then press **OK**.
- 3 Use ▲▼◀▶ to select the item you want to adjust, then press **OK**.

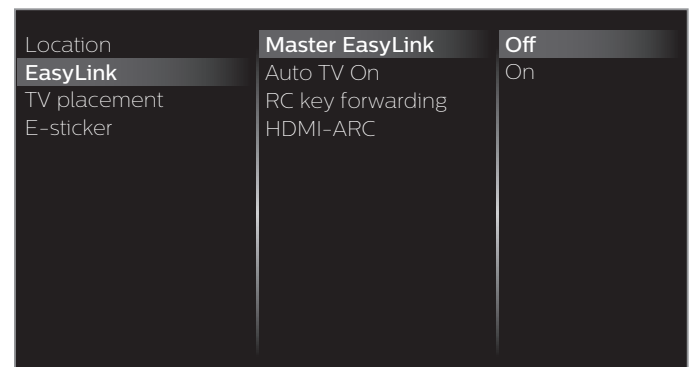

Set the **Master EasyLink** to **On** or **Off**. The following additional settings will be grayed out when you set them to **Off**.

<b>Master EasyLink</b>	<b>Off</b>	Disables all EasyLink.
	<b>On</b>	Selects if you have connected an external device that is compatible with the EasyLink function.

This unit will turn on when the power on signal is sent from your connected EasyLink device.

<b>Auto TV On</b>	<b>Off</b>	This unit stays in Standby mode even if you turn on your connected EasyLink device.
	<b>On</b>	This unit turns on automatically when you turn on your connected EasyLink device.

You can operate some functions such as disc playback or call up the menu of the connected devices, by using this unit's remote control.

<b>RC key forwarding</b>	<b>Off</b>	Disable RC key forwarding.
	<b>On</b>	<b>PLAY, PAUSE</b> / <b>STOP</b> / <b>FWD</b> / <b>REV</b> / <b>VOL + / -</b> / <b>(MUTE)</b> / <b>OPTIONS</b> / <b>▲▼◀▶</b> / <b>OK</b> / <b>↩ BACK</b> / the <b>NUMBER</b> buttons can be used to control your connected EasyLink devices by this unit's remote control.

#### Note(s)

- Pause may not work properly on some devices even if they are EasyLink (HDMI CEC) compliant.

HDMI-ARC allows you to use Philips EasyLink to output TV audio directly to a connected audio device, without the need for an additional digital audio cable.

<b>HDMI-ARC</b> (HDMI 2 only)	<b>Off</b>	Disable HDMI-ARC.
	<b>On</b>	You can output TV audio through the HDMI cable solely, provided both the TV and device are HDMI-ARC compliant.

## Return your settings to default values

You can return settings to their default values.

- 1 Use **▲▼** to select **Restore default settings**, then press **OK**.
- 2 Use **▲▼** to select **Reset AV settings** or **Reset all settings**, then press **OK**.

<b>Reset AV settings</b>	Return picture and sound settings to their default values. The channel installation settings are not affected.
<b>Reset all settings</b>	Return all the settings to their default values.

## Accessibility

- 1 Press **⬆** and use **◀▶** to select **Setup** then press **OK**.
- 2 Use **▲▼◀▶** to select **TV settings**, then press **OK**.
- 3 Use **▲▼** to select **Accessibility**, then press **OK**.

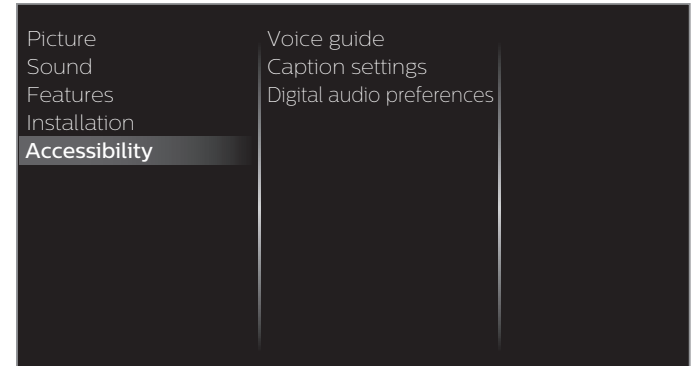

- 4 Adjust the following items.

## Voice guide

Lets you configure voice guide and its settings.

- 1 Use **▲▼** to select **Voice guide**, then press **OK**.

<b>Voice guide toggle</b>	<b>Off</b>	To set Voice guide off
	<b>On</b>	To set Voice guide on
<b>Speed</b>	<b>Fast</b>	Set voice guide speed based on your preference
	<b>Normal</b>	
	<b>Slow</b>	
<b>Pitch</b>	<b>High</b>	Set voice guide pitch based on your preference
	<b>Normal</b>	
	<b>Low</b>	
<b>Verbosity</b>	<b>Verbose</b>	Set voice guide explanation verbosity based on your preference
	<b>Succinct</b>	
<b>Volume level</b>	<b>Loud</b>	Set voice guide volume based on your preference
	<b>Normal</b>	
	<b>Soft</b>	



## Caption settings

Closed captions displays the audio portion of the program as superimposed text over the video.

1 Use ▲▼ to select **Caption settings**, then press **OK**.

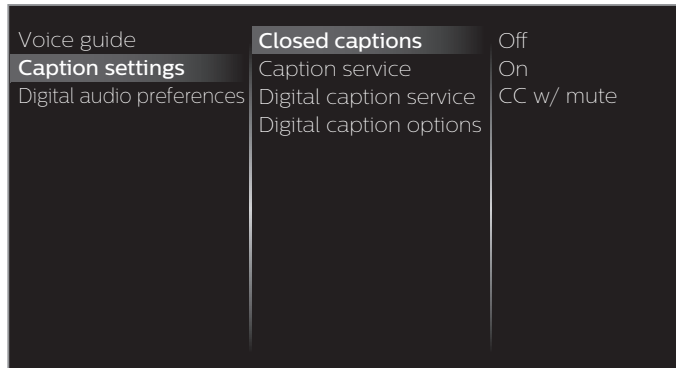

Closed captions	Off	Closed caption is not displayed.
	On	Closed caption is always displayed.
	CC w/ mute	Closed caption is displayed when the sound is off.

## Digital TV operation

In addition to the basic closed caption, DTV has its own closed caption called digital caption service. Use this menu to change the settings for digital caption service.

Digital caption service	CS-1 to CS-6	Select one of these before changing any other item in <b>Caption settings</b> menu. Choose <b>CS-1</b> under normal conditions.
-------------------------	--------------	---

You can choose the size, font, color, background and other characteristics of the caption text.

Digital caption options	Reset to default	You can reset the status of digital caption options.
		You can change closed captioning font style, size, color and transparency. ( <b>Font style</b> , <b>Font size</b> , <b>Font color</b> and <b>Font opacity</b> )
		You can change background color and transparency of the displayed caption. ( <b>Background color</b> and <b>Background opacity</b> )
		You can change edge color and type of the displayed caption text. ( <b>Edge color</b> and <b>Edge type</b> )



- Review your setting choice made above by looking in the upper left corner of the displayed setting box (not all selections show the differences selected).

## Cable / NTSC (Analog) TV operation

Caption service	CC-1 and T-1	The primary closed captions and text services. The closed captions or text is displayed in the same language as the program's dialog (up to 4 lines of script on the TV screen).
	CC-3 and T-3	Serve as the preferred data channels. The closed captions or text is often a secondary language.
	CC-2, CC-4, T-2 and T-4	Rarely available and broadcasters use them only in special conditions, such as when <b>CC-1</b> and <b>CC-3</b> or <b>T-1</b> and <b>T-3</b> are not available.

- There are 3 display modes according to programs:

Paint-on	Displays characters on the TV screen immediately.
Pop-on	Once characters are stored in memory, they are displayed all at once.
Roll-up	Displays the characters continuously by scrolling (max. 4 lines).

**Note(s)**

- Digital caption service** that you can switch differs depending on the broadcast description.
- Closed captioning service may not be controlled by this unit's menu options if you are watching television through an external cable or satellite set-top box. In which case you will need to use the menu options on the external set-top box to control closed captioning.
- The captions do not always use correct spelling and grammar.
- Not all TV programs and product commercials include closed caption information. Refer to your area TV program listings for the TV channels and times of closed caption shows. The captioned programs are usually noted in the TV listings with service marks such as **CC**.
- Not all captioning services are used by a TV channel during the transmission of a closed caption program.
- Closed caption will NOT be displayed when you are using an HDMI or a component connection.
- To show the closed caption on your TV screen, broadcast signal must contain the closed caption data.
- Not all TV programs and commercials have the closed caption or all types of the closed caption.
- Caption's and text may not exactly match the TV voice.
- Changing channels may delay the closed caption for a few seconds.
- Adjusting or muting the volume may delay the closed caption for a few seconds.
- Abbreviations, symbols and other grammatical shortcuts may be used in order to keep pace with the on-screen action. This is not a malfunction.
- The caption or text characters will not be displayed while the Main menu or functions display is shown.
- If a black box appears on the TV screen, this means that the closed caption is set to the text mode. To clear the box, select **CC-1**, **CC-2**, **CC-3** or **CC-4**.
- If the unit receives poor quality television signals, the captions may contain errors or there might be no captions at all. Some possible causes of poor quality signals are:
  - Automobile ignition noise
  - Electric motor noise
  - Weak signal reception
  - Multiplex signal reception (ghosts or screen flutter)
  - Data dropout and pixelation (for DTV only)
- The unit retains the closed caption setting if the power fails.
- When the unit receives special effects playback signal (e.g. search, slow and still) from a VCR's video output channel (ch3 or ch4), the unit may not display the correct caption or text.
- The EUT setting that satisfies § 79.102 (e) is as follows:
  - Font: Mono-font
  - Character size: Large

## Digital audio preferences

You can set the interpretive broadcasting by an audio explanation.

- 1 Use ▲▼ to select **Digital audio preferences**, then press **OK**.

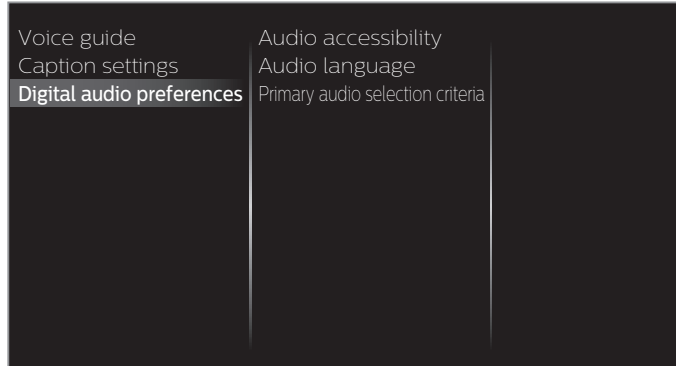

<b>Audio accessibility</b>	To prioritize VI-Visually Impaired streaming or HI-Hearing Impaired streaming. The setting for handicapped users ( <b>Main audio, Visually Impaired</b> or <b>Hearing Impaired</b> ).
<b>Audio language</b>	To set your preferred language in the audio streaming ( <b>English, Spanish</b> or <b>French</b> ).
<b>Primary audio selection criteria</b>	To set TV priority based on either of the above settings: ( <b>Audio accessibility</b> or <b>Audio language</b> ).

## Search for channels

Be sure the RF cable is correctly connected to this unit and you are registered with your cable TV provider when you install cable channels.

- 1 Press **Home** and use **Left/Right** to select **Setup**, then press **OK**.
- 2 Use **Up/Down/Left/Right** to select **Search for channels**, then press **OK**.
- 3 Use **Left/Right** to select **Start**, then press **OK**.

## Install channels

You can search and store all channels. If you move the unit to a different area after the initial setting, it is recommended to perform Autoprogramming.

- 4 Use **Up/Down** to select **Antenna** or **Cable**, then press **OK**.
- 5 Press **OK** on **Start**.
  - When the scanning and memorizing of available channels is completed, the lowest memorized channel will be displayed.
- 6 Follow the on-screen instructions to complete the installation.

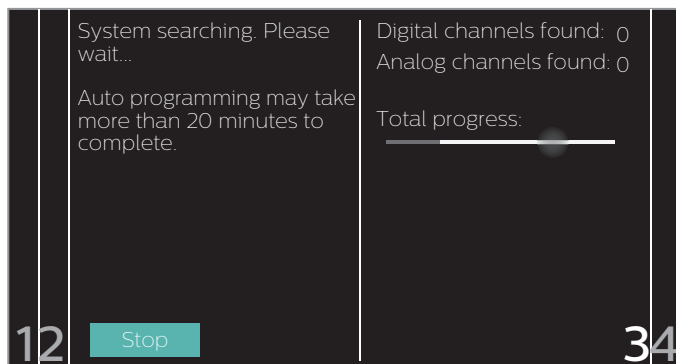

## Channel settings

- 1 Press **Home** and use **Left/Right** to select **Setup**, then press **OK**.
- 2 Use **Up/Down/Left/Right** to select **Channel settings**, then press **OK**.
- 3 Adjust the following items.

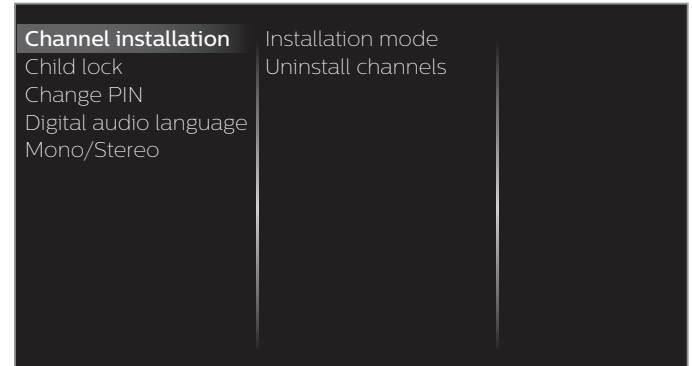

## Channel installation

Be sure the RF cable is correctly connected to this unit and you are registered with your cable TV provider when you install cable channels.

### Installation mode

- 1 Use **Up/Down** to select **Channel installation**, then press **OK**.
- 2 Use **Up/Down** to select **Installation mode**, then press **OK**.
- 3 Use **Up/Down** to select **Antenna** or **Cable**, then press **OK**.
  - When **Antenna** is selected, the TV detects antenna signals. It searches for DTV and analog TV channels available in your area.
  - When **Cable** is selected, the TV detects signals supplied by cable. It searches for DTV, analog TV and cable channels available in your area.

### Uninstall channels

The channels selected here can be skipped when selecting the channels using **CH + / -**.

Those channels can still be selected with **the NUMBER buttons**.

- 1 Use **Up/Down** to select **Channel installation**, then press **OK**.
- 2 Use **Up/Down** to select **Uninstall channels**, then press **OK**.
- 3 Use **Up/Down** to select the channel you want to remove, then press **OK**.
  - The removed channels are not displayed on the list of favorite channels.
  - To reactivate a removed channel, use **Up/Down** then press **OK**.

## Child lock

You can prevent your children from watching certain programs or certain channels by locking the TV controls and by using ratings.

1 Use **▲▼** to select **Child lock**, then press **OK**.

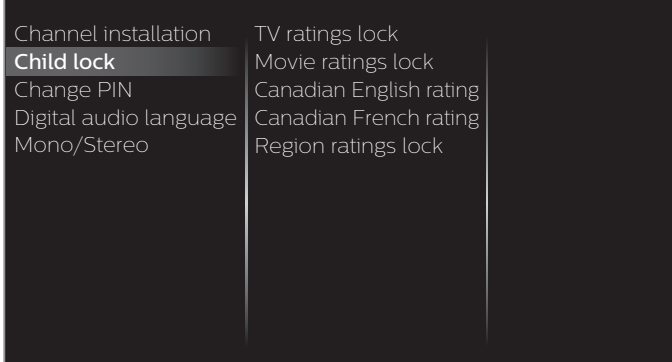

2 Use the **NUMBER** buttons to enter the 4-digit numbers for your PIN code.

- When you have not set up your PIN code, enter **0, 0, 0, 0**.
- When the PIN code is correct, **Child lock** menu is displayed. See the following description for setting each item.

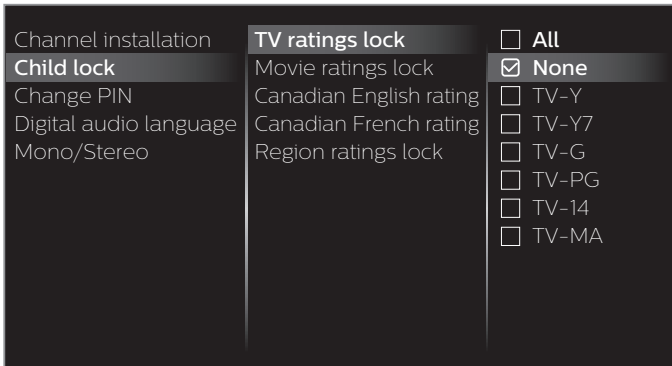

### Note(s)

- When you select the higher rating and set it to  the lower ratings will be blocked automatically.
- To remove all blocks place a check in the **All** box and then remove that check to remove all blocks.
- **Region ratings lock** will be available when the unit receives a digital broadcast using the new rating system.
- To block any inappropriate programs, set your limits in **TV ratings lock**, **Movie ratings lock** and **Region ratings lock**.
- For the United States, the unit may download the region ratings lock table, if required.
- The Canadian rating systems on this unit are based on CEA-766-A and CRTCC policy.

## Setting TV and movie ratings

Movie ratings lock is the rating system created by MPAA. TV ratings lock has controlled access to individual programs based on their age ratings and content rating.

3 Use **▲▼** to select **TV ratings lock** or **Movie ratings lock**, then press **OK**.

4 Use **▲▼** to select the desired rating, then press **OK** repeatedly to switch between block and view.

- indicates that the rating is locked (Blocked).
- indicates that the sub rating is locked (Blocked).
- indicates that the rating is not locked (Viewable).

## TV ratings lock

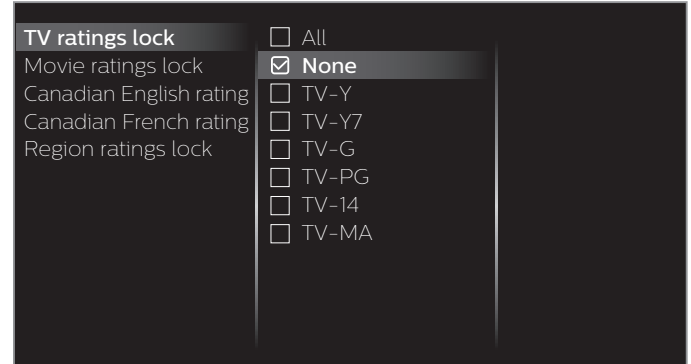

## Movie ratings lock

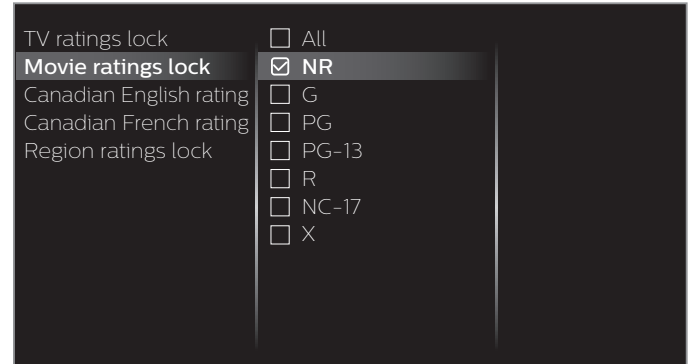

US movie ratings	US TV ratings	Description
All	All	All ratings locked including no rating
NR	None	No rating
–	TV-Y	Appropriate for all children
–	TV-Y7	Appropriate for all children 7 and older
G	TV-G	General audience
PG	TV-PG	Parental guidance suggested
PG-13	–	Unsuitable for children under 13
–	TV-14	Unsuitable for children under 14
R	–	Restricted under 17 requires accompanying parent or adult guardian
NC-17	–	No one under 17 admitted
X	TV-MA	Mature audience only

### To set the sub ratings (displayed in the right column)

For TV ratings lock, you can further set the sub ratings to block specific elements of programming. To set the sub ratings, follow the step below.

Use **▲▼◀▶** to select the desired rating, then press **OK** repeatedly to switch between  and .

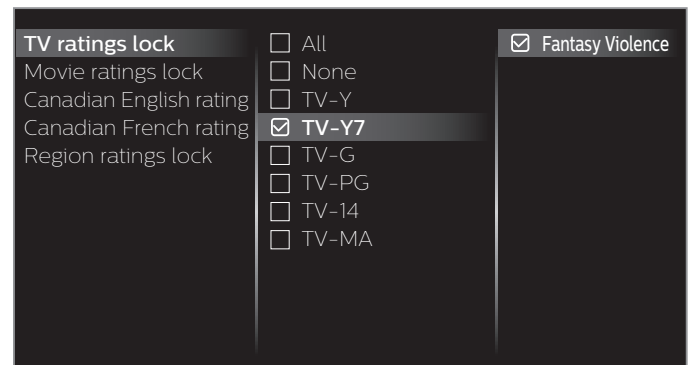

US TV ratings	Sub rating
TV-Y7	Fantasy Violence
TV-PG	Violence Sex
TV-14	Language Dialog
TV-MA	Violence Sex Language

#### Note(s)

- Blocked sub rating's will appear beside the main rating category in **TV ratings lock** menu.
- You cannot block a sub rating if the main rating is set to .
- Changing the category to  or  automatically changes all its sub ratings to the  or .

## Change PIN

Although the default PIN code (0000) is supplied with the unit, you can set your own PIN code.

- Use **▲▼** to select **Change PIN**, then press **OK**.
- Press the **NUMBER buttons** to enter the current 4-digit PIN code.
- Press the **NUMBER buttons** to enter the new 4-digit PIN code.
  - Enter PIN code again to confirm.

#### Note(s)

- Make sure new PIN code and confirm PIN code must be exactly the same. If they are different, the space is cleared for reentering.
- If you have forgotten your PIN code, enter **0711** to reset the PIN code.

## Canadian English or Canadian French ratings

You can select the rating for Canadian English or Canadian French broadcasting.

- Use **▲▼** to select **Canadian English rating** or **Canadian French rating**, then press **OK**.
- Use **▲▼** to select the desired rating, then press **OK** repeatedly to switch between block and view.
  - indicates that the rating is locked (Blocked).
  - indicates that the rating is not locked (Viewable).

Canadian English rating	Canadian French rating	Description
All		Locked all ratings
E		Exempt program
C	–	For all children
C8+	–	For all children 8 and older
G		General audience
–	8 ans+	Unsuitable for ages under 8
PG	–	Parental guidance suggested
–	13 ans+	Unsuitable for ages under 13
14+	–	Unsuitable for ages under 14
–	16 ans+	Unsuitable for ages under 16
18+	18 ans+	Adult audience only

#### Note(s)

- The V-Chip can block non rated programs as per "CEA-608-E sec. L3". If the option to block **NR**, **None** or **E** programs are used in **Movie ratings lock**, **TV ratings lock**, **Canadian English rating** or **Canadian French rating** accordingly "unusual results may occur and the unit may not receive emergency bulletins or other types of programming"; / Emergency bulletins (Such as EAS messages, weather warnings and others) / Locally originated programming / News / Political / Public service announcements / Religious / Sports / Weather.

## Digital audio language

You can select the audio language while your TV is receiving the digital broadcasting.

- Use **▲▼** to select **Digital audio language**, then press **OK**.

<b>Digital audio language</b>	To select the language according to your preference. (It differs depending on the program.)
-------------------------------	--

## Mono/Stereo

### Cable / NTSC (Analog) TV operation

You can select an audio format while your TV is receiving the analog broadcasting.

- Use **▲▼** to select **Mono/Stereo**, then press **OK**.
- Use **▲▼** to select **Mono**, **Stereo** or **SAP** (Second Audio Program), then press **OK**.

## Connect to network

Setup network connection settings in order to use Net TV or network upgrade functions.

- The meanings of abbreviations are defined as below.  
**AP** : Wireless LAN access point  
**SSID** : Wireless network name
- The key entry screen will appear when you select SSID, WEP / others or proxy address.

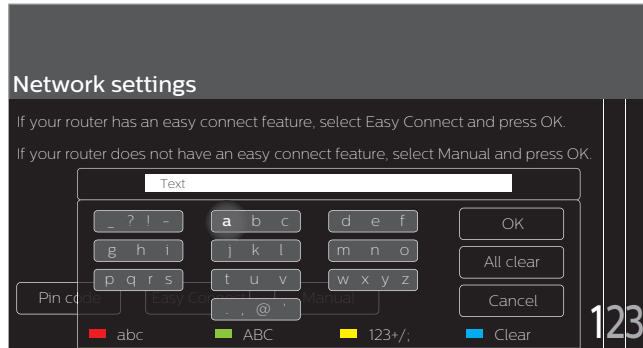

- Enter the key of the selected wireless network using ▲▼◀▶, then press **OK**.
- Clear** : Clear the entered number or word.
- All clear** : Clear all the entered numbers or words.
- abc** : Switch to the small letter mode.
- ABC** : Switch to the capital letter mode.
- 123+;/** : Switch to the numeral and symbol mode.
- Cancel** : Shows the cancellation display.
- OK** : Set the entered number or word.

- Press **Home** and use **Left/Right** to select **Setup**, then press **OK**.
- Use **Up/Down/Left/Right** to select **Connect to network**, then press **OK**.

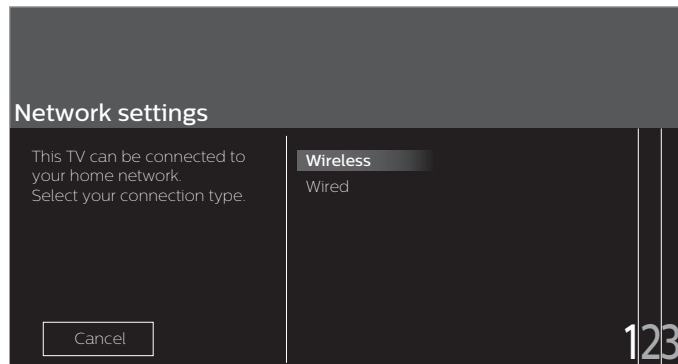

- Adjust the following items.

## Wireless setting

Select to use a wireless LAN to connect to the internet by a wireless connection.

- Use **Up/Down** to select **Wireless**, then press **OK**.
- Use **Left/Right** to select the desired setting, then press **OK**, and follow the on-screen instructions.

<b>Easy Connect</b>	Select this setting if your router has an easy connect button. Start scanning for wireless networks on the TV after pressing the easy connect button on your router. If connection test fails, refer to the router's manual for more details.
<b>Scan</b>	Search for wireless networks automatically and select the wireless network name (SSID) from the list.
<b>Manual entry</b>	Set up the connection to the wireless LAN Access Point (AP) (e.g. wireless router) manually by entering the wireless network name (SSID).

\* Easy Connect cannot be used when the security protocol is set to WEP. Change the Access Point's security mode from WEP to others (recommended).

## Wired setting

Select to use an Ethernet cable to connect to the internet by a wired connection. Please purchase shielded Ethernet cables at your local store and use it when you connect to network equipment.

- Use **Up/Down** to select **Wired**, then press **OK**.
  - Connection test** will start automatically. → p. 40

## Network settings

- 1 Press **⬆** and use **⬅➡** to select **Setup**, then press **OK**.
- 2 Use **▲▼⬅➡** to select **Network settings**, then press **OK**.
- 3 Adjust the following items.

## Manual network settings

- 1 Use **▲▼** to select **Manual network settings**, then press **OK**.

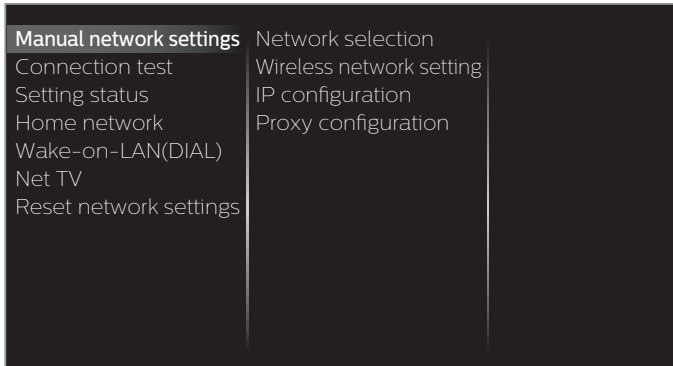

### Network selection

- 2 Use **▲▼** to select **Network selection**, then press **OK**.
- 3 Use **▲▼** to select the desired setting, then press **OK**.

<b>Wired</b>	If you connect to an Ethernet cable, select <b>Wired</b> to connect to the internet.
<b>Wireless</b>	If you have a router with easy connect function, select <b>Wireless</b> to connect to the internet.

## Wireless network setting

This menu is displayed only when you set **Wireless** in **Network selection**. In order to use a wireless network, you must set up a connection to the AP (e.g. wireless router).

- 2 Use **▲▼** to select **Wireless network setting**, then press **OK**.

### Auto

Search for wireless networks automatically and select the SSID from the list.

- 3 Use **▲▼** to select **Auto**, then press **OK**.
- 4 The list of wireless networks will be displayed. Use **▲▼** to select the appropriate the SSID, then press **OK**.

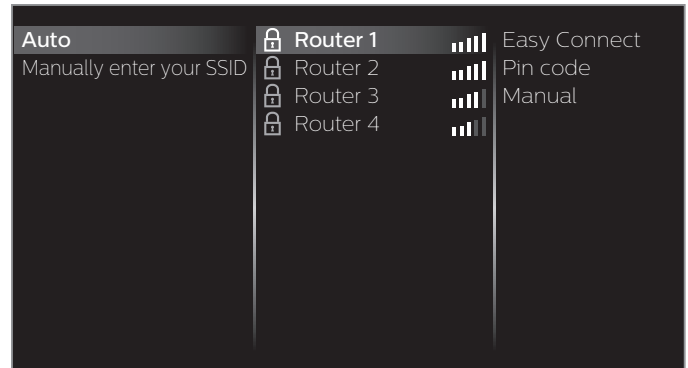

- If you select the SSID with **🔒**, WEP\*2 / others Key entry screen will appear. Enter the WEP\*2 / others key of the selected wireless network using **▲▼⬅➡**, then press **OK**.
- If you select the SSID has an easy connect, the easy connect setting screen will appear. Use **▲▼⬅➡** to select a setting, then press **OK**.

<b>Easy Connect</b>	Select this setting if your router has an easy connect button. Start scanning for wireless networks on the TV after pressing the easy connect button on your router. If connection test fails, try <b>Easy Connect</b> again.*1 If it fails then refer to the router's manual for more details.
<b>Pin code</b>	Select this setting if your router has an easy connect feature but does not have an easy connect button. Enter the 8-digit PIN code shown on your TV in the Router settings menu via PC before <b>Connect</b> is selected.
<b>Manual</b>	If your wireless network with authentication setting (WEP*2, others), WEP*2 / others Key entry screen will appear. Enter the WEP*2 / others key of the selected wireless network using <b>▲▼⬅➡</b> , then press <b>OK</b> .

\*1 Easy Connect cannot be used when the security protocol is set to WEP. Change the Access Point's security mode from WEP to others (recommended).

\*2 WEP is not recommended to be used due to its major security flaws. Change the security protocol on the wireless router to others (recommended) mode.

Confirmation message will appear. Select **OK** to complete the settings.

### Note(s)

- For a wireless network with authentication setting, key icon appears to the right hand of the SSID.
- Signal icon shows the strength of the signal.
- WEP\*2 / others key appears as asterisks on the confirmation screen.
- The wireless LAN supports following specifications.
  - Wireless standards: IEEE 802.11 b/g/n
  - Frequency spectrum: 2.4GHz
  - Security protocol: WEP\*2 / others

**Manually enter your SSID**

Set up the connection to the AP (e.g. wireless router) manually by entering the SSID.

- 3 Use ▲▼ to select **Manually enter your SSID**, then press **OK**.
  - AP (e.g. wireless router) SSID entry screen will appear.
 Enter the SSID using ▲▼◀▶, then press **OK**.
- 4 Use ▲▼ to select the authentication setting of the selected wireless network.
  - For a wireless network with authentication setting, select the authentication setting, according to the security type of the wireless network.



None	Set the authentication setting to <b>None</b> .
WEP	Set the authentication setting to <b>WEP*</b> .
Others	Set the authentication setting to <b>Others</b> .

- For a wireless network without authentication setting, select **None**.
  - If you select **WEP\*** or **Others**, WEP\* / others Key entry screen will appear. Enter the WEP\* / others key of the selected wireless network using ▲▼◀▶, then press **OK**.
  - Confirmation message will appear. Select **Yes** to complete the settings.
- \* WEP is not recommended to be used due to its major security flaws. Change the security protocol on the wireless router to others (recommended) mode.

**IP configuration**

In following cases, select **IP configuration** to set each setting as necessary.

- When connection test failed with the setting of **Connection test**.
- When instructed by your Internet service provider to make specific settings in accordance with your network environment.

- 2 Use ▲▼ to select **IP configuration**, then press **OK**.
- 3 Use ▲▼ to select a setting, then press **OK**.

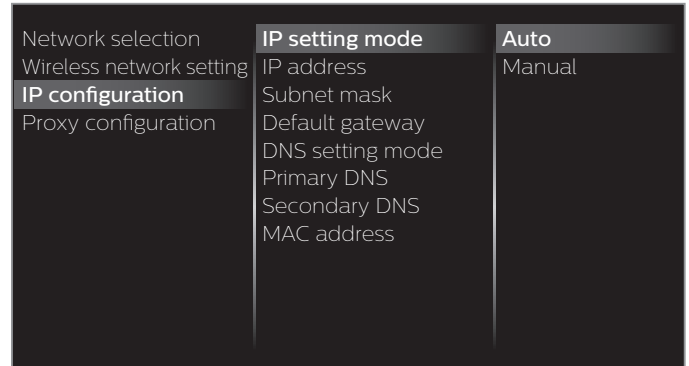

IP setting mode	Auto	Sets the IP setting automatically.
	Manual	Sets the IP setting manually.
IP address *1, 3		A set of numbers which are assigned to devices participating in a computer network.
Subnet mask *1, 3		A mask which is used to determine what subnet an IP address belongs to.
Default gateway *1, 3		IP address of the network device (such as router) which provides internet access.
DNS setting mode	Auto	Sets the DNS setting automatically.
	Manual	Sets the DNS setting manually.
Primary DNS *2, 3		A server which handles the name and IP address over the internet.
Secondary DNS *2, 3		A server which handles the name and IP address over the internet.
MAC address		An address which recognizes the devices connecting to the network. It is also called hardware address.

- \*1 Items can be selected only when **IP setting mode** is set to **Manual**.
- \*2 Items can be selected only when **DNS setting mode** is set to **Manual**.
- \*3 Use ▲▼ or the **NUMBER** buttons to input numbers. When you use ▲▼ to input numbers, then press **OK** or input the triple digits by using the **NUMBER** buttons, the cursor moves to the next entry field. When you use ▲▼ to input numbers, then press **OK** or input the triple digits by using the **NUMBER** buttons at the rightmost entry field, numbers will be stored and go back to the previous menu.

**Note(s)**

- The range of input numbers is between 0 and 255.
- If you enter a number larger than 255, the number will automatically be 255.
- The manually entered number will be saved even if you change the setting to **Auto**.
- If you want to enter 1 or 2 digit number in one cell, press **OK** to move on to the next cell.
- If the entered IP address or the default gateway or primary DNS number is same as the default setting, IP address setting will be set to **Auto**. (The manually entered number will be saved).
- When IP address setting is set to **Manual**, the setting of DNS setting will automatically be **Manual** and when IP address setting is set to **Auto**, you can set either **Auto** or **Manual** for DNS setting.

## Proxy configuration

- 2 Use ▲▼ to select **Proxy configuration**, then press **OK**.
- 3 Use ▲▼ to select a setting, then press **OK**.

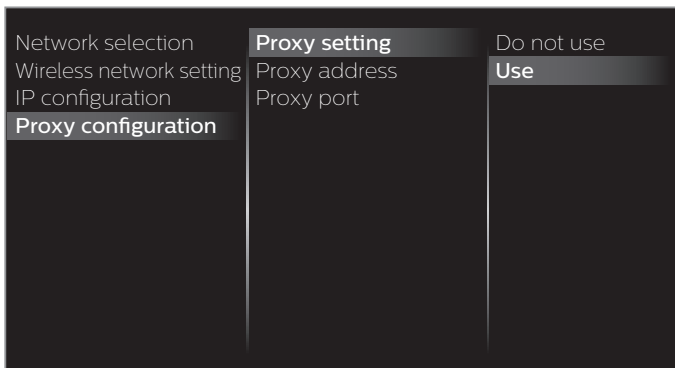

- **Do not use** is selected for default settings.
- If you need to change the proxy setting as instructed by your internet service provider to set the designated proxy address and port, select **Use**.

Proxy setting	Do not use	Does not use the proxy server.
	Use	Uses the proxy server.
Proxy address *	Selects the number or word by using ▲▼◀▶, then press <b>OK</b> .	
Proxy port *	Use ▲▼ or the <b>NUMBER</b> buttons to input numbers.	

\* Items can be selected only when **Proxy setting** is set to **Use**.

### Note(s)

- The range of input numbers for the port number is between 0 and 65535. (If you enter a number larger than 65535, it will be regarded as 65535.)
- For proxy port, the selected ports may be blocked and not be able to use depending on your network environment.
- If the proxy address is entered with blank only, proxy server setting will be set to **Do not use**.

## Connection test

Perform the following steps to test your internet connection after you have connected an Ethernet cable or entered network settings such as IP address, DNS settings, etc. manually.

- 1 Use ▲▼ to select **Connection test**, then press **OK**
  - Connection test will start automatically and the test result for home network and internet will appear right after the connection test finishes.
  - **"Testing.."** is displayed while the connection test is in progress.

Home network	Internet	Description
Pass	Pass	Connection test is successfully completed.
Fail	-	Connection test for home network failed. Check the connection settings.
Pass	Fail	Connection test for internet failed. Check the connection settings.

- If the connection test for internet passes, speed test will start automatically.

- 2 Press **OK** to go to the list on network status confirmation screen.

### Note(s)

- If the connection test for both home network and internet pass, you are ready to use Net TV or network upgrade functions using the internet without making any additional settings.
- If the connection test fails, check if the Ethernet cable is connected to this TV properly or if you have entered all the required details for the wireless LAN connection properly.

## Setting status

You can check the status of network settings.

- 1 Use ▲▼ to select **Setting status**, then press **OK**
  - Network setting list will be displayed.
  - MAC address of this unit will be displayed in the list.



## Home network

You can turn your TV into a Digital Media Renderer (DMR), which can play video, music and photo files stored on certified home media servers connected to your home network.

- 1 Use ▲▼ to select **Home network**, then press **OK**.
- 2 Use ▲▼◀▶ to select the item you want to adjust, then press **OK**.

Renderer	Off	Disable DMR.
	On	Enable this unit to play files using DMC.
Renderer name	Change the display name of this TV to other devices on the home network.	

## Wake-on-LAN(DIAL)

You can turn your TV on when you use remote control via IP.

- 1 Use ▲▼ to select **Wake-on-LAN(DIAL)**, then press **OK**.
- 2 Use ▲▼ to select **On** or **Off**, then press **OK**.

Off	To set <b>Wake-on-LAN(DIAL)</b> to off.
On	To set <b>Wake-on-LAN(DIAL)</b> to on.

## Net TV

Displays the deactivation settings for Net TV, Netflix ESN and Netflix software version.

### Netflix deactivation

Displays the deactivation setting for Netflix.

- 1 Use ▲▼ to select **Net TV**, then press **OK**.
- 2 Use ▲▼ to select **Net TV deactivation**, then press **OK**.
- 3 Use ▲▼ to select **Netflix**, then press **OK**.
- 4 Use ◀▶ to select the desired option, then press **OK**.

Yes	Deactivate the connection to Netflix.
No	Activate the connection to Netflix.

### YouTube deactivation

Displays the deactivation setting for YouTube.

- 1 Use ▲▼ to select **Net TV**, then press **OK**.
- 2 Use ▲▼ to select **Net TV deactivation**, then press **OK**.
- 3 Use ▲▼ to select **YouTube**, then press **OK**.
- 4 Use ◀▶ to select the desired option, then press **OK**.

Yes	Deactivate the connection to YouTube.
No	Activate the connection to YouTube.

### Netflix ESN

Displays the ESN information.

- 1 Use ▲▼ to select **Net TV**, then press **OK**.
- 2 Use ▲▼ to select **Netflix ESN**, then press **OK**.
  - Displays the ESN (Electronic Serial Number) to get any services from Netflix.

### Netflix software version

Displays the Netflix version.

- 1 Use ▲▼ to select **Net TV**, then press **OK**.
- 2 Use ▲▼ to select **Netflix software version**, then press **OK**.

## Reset network settings

You can reset the status of network settings.

- 1 Use ▲▼ to select **Reset network settings**, then press **OK**.
- 2 Use ◀▶ to select the desired option, then press **OK**.

## Update software

Philips continuously tries to improve its products and we strongly recommend that you upgrade the TV software when upgrades are available.

New software can be downloaded from our website at [www.philips.com/support](http://www.philips.com/support) using the model number of your TV to find information.

You can update the software through these methods:

- Update with USB memory stick
- Update from digital broadcast **Update notification** → p. 43

This section describes how to upgrade the software by using USB memory stick.

## Preparing for the software upgrade

You require the following equipment:

- A PC with web browsing capability
- An archive utility that supports the ZIP-format (e.g. WinZip for Windows or Stuffit for Mac OS)
- An empty clean formatted USB memory stick

### Note(s)

- Only FAT / DOS-formatted portable memory is supported.
- Use only software upgrades that can be found on the Philips web site.

### Warning

- When the software upgrade is running, don't press any buttons.
- Do not remove the USB memory stick during the software upgrade.
- If an error occurs during the upgrade, retry the procedure or for further assistance, please contact call center.

## Downloading the software

Find information and software related to your TV and download the latest software upgrade file to your PC.

Prepare a blank USB memory stick for software update. Access [www.philips.com/support](http://www.philips.com/support) and download the latest version software to a blank USB memory stick using a PC by following the directions described on the website.

- Use a blank USB memory stick, download the software on your PC and write the software in the root directory of the USB memory stick.
- For more details on how to download the software, please refer to the website.

## USB upgrade

You can upgrade the software by using USB memory stick.

- 1 Connect your USB memory stick with the upgrade file to the USB terminal on the side of your TV.

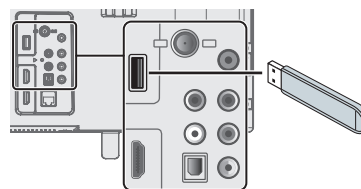

- 2 Press **Home** and use **Left/Right** to select **Setup**, then press **OK**.
- 3 Use **Up/Down/Left/Right** to select **Update software**, then press **OK**.
- 4 Use **Up/Down** to select **USB**, then press **OK**.
- 5 Use **Up/Down/Left/Right** to select the desired update file, then press **OK**.
- 6 Use **Left/Right** to select **Yes**, then press **OK**.
  - Read the on-screen instructions and confirm that you want to continue with the installation.

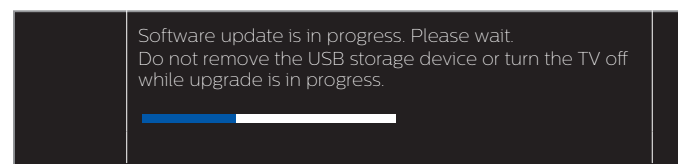

- 7 When the software upgrade is completed, press **Power** to set the unit into standby mode, then remove the USB memory stick.
- 8 Unplug the AC power cord for a few seconds from AC outlet and plug it again.
- 9 Press **Power** again to turn the unit on.
  - The TV starts up with the new software.
  - For further assistance, please contact call center.

## Network updates

You can update the software by connecting the unit to the internet.

- 1 Press **⬆** and use **⬅➡** to select **Setup**, then press **OK**.
- 2 Use **▲▼⬅➡** to select **Update software**, then press **OK**.
- 3 Use **▲▼** to select **Network**, then press **OK**.
- 4 Use **⬅➡** to select **Yes**, then press **OK**.
  - This unit will then start checking for the latest FirmWare (software) version.
- 5 Confirmation message will appear.
  - Use **⬅➡** to select **Yes**, then press **OK**.
    - The unit will start downloading the latest FirmWare (software) version.
    - The unit will start updating the FirmWare (software) version.
    - It may take a while to complete the updating.
- 6 When the software update is complete, press **⏻** to make sure the unit goes to standby mode.
- 7 Unplug the AC power cord for a few seconds from AC outlet and plug it again.
- 8 Press **⏻** again to turn the unit on.
  - The TV starts up with the new software.

For further assistance, please contact call center.

### Note(s)

- In order to update software via the Internet, you must connect the unit to the Internet and set up necessary settings.  
**Connect to network** → p. 37  
**Network settings** → p. 38
- Please do not unplug the AC power cord or Ethernet cable while executing the **Network updates**.
- All settings will remain the same even if you update the software version.
- The version of net service will also be updated if newer version of net service is available when updating the firmware.
- When you start up the TV or a net service after executing the software update, a message may appear on the screen prompting for software update again. In this case, please select **Update** to start USB update or network update. For further assistance, please contact call center.

## Software settings

### Software

- 1 Press **⬆** and use **⬅➡** to select **Setup**, then press **OK**.
- 2 Use **▲▼⬅➡** to select **Software settings**, then press **OK**.
- 3 Use **▲▼** to select **Software**, then press **OK**.

### Checking your current software version number

- 1 Use **▲▼** to select **Software information**, then press **OK**.
  - The version and a description of the current software is displayed.

### Update notification

You can download the latest software through the air and update this unit automatically while the unit is in standby mode.

- 1 Use **▲▼** to select **Update notification**, then press **OK**.
- 2 Use **▲▼** to select the desired option, then press **OK**.

Off	Disable auto-update for latest software.
On	A message will appear if there is the latest software on the network server.

### License

Displays the licenses of open source software used in this unit.

- 1 Use **▲▼** to select **License**, then press **OK**.
  - Licenses of open source software used in this unit are displayed.

### Digital rights management

This product contains technology subject to certain intellectual property rights of Microsoft. Use or distribution of this technology outside of this product is prohibited without the appropriate license(s) from Microsoft.

- 1 Use **▲▼** to select **Digital rights management**, then press **OK**.
  - Digital rights management is displayed.

## View photos, play music and watch videos using home network

On your TV you can play video, music and photo files stored on home network certified home media servers connected to your home network. In order to use this feature, you must connect this unit to the internet.

It is recommended that files to be played back in this unit are recorded under the following specifications:

Picture (JPEG / Progressive JPEG)		
JPEG	Upper limit	4000x4000 pixels
Progressive JPEG	Upper limit	1024x768 pixels

Music (MP3 / WAV / AAC)		
MP3	Sampling frequency	32 kHz or 44.1 kHz or 48 kHz
	Constant bit rate	32 kbps - 320 kbps
WAV	Sampling frequency	8 kHz - 48 kHz
	Constant bit rate	64 kbps - 1.5 Mbps
AAC	Sampling frequency	8 kHz - 48 kHz
	Constant bit rate	-

Video (MPEG / VOB / AVI / MP4)						
Maximum video	H.264, H.265/HEVC, MPEG: 1920x1080@60fps					
Extension	.avi	.mpg, .mpeg	.ts, .trp, .tp	.vob	.mp4	.mkv
Video codec	MPEG1, MPEG2, MPEG4, H.264	MPEG1, MPEG2, MPEG4	MPEG1, MPEG2, H.264, H.265/HEVC	MPEG1, MPEG2	MPEG1, MPEG2, MPEG4, H.264, H.265/HEVC	MPEG1, MPEG2, MPEG4, H.264, H.265/HEVC
Audio codec						
Dolby Digital	YES	YES	YES	YES	YES	YES
MPEG1/2 audio layer1/2/3	YES	YES	YES	YES	NO	YES
LPCM	YES	YES	YES	YES	YES	YES
AAC-LC	YES	YES	YES	YES	YES	YES

### Note(s)

- A maximum of 1,023 folders or files can be recognized.
- For the home server list, maximum of 16 servers can be displayed.
- The 10th and deeper hierarchies cannot be displayed.
- Unplayable files in the home server will not be displayed in the file list.
- For some files, playback is not available even if displayed in the file list.
- In order to play back the contents in home servers, the player and the servers must be connected to the same access point.
- Compatibility and available playback function may differ depending on the home server.
- Video files with unsupported audio format will be skipped.
- The quality of the playback picture or audio differs depending on your network condition.

## Before using home network

Follow the procedure below before using home network.

- 1 Connect this unit to the internet.
  - **Connecting the TV to the internet using an Ethernet cable** → p. 13 or **Connecting the TV to the internet using a wireless LAN** → p. 14
  - Broadband internet connection of 8Mbps or faster is required.
- 2 Set up the necessary network connection settings.
  - **Connect to network** → p. 37

## Using home network

- 1 Start home network media servers in your home network.
  - For details, refer to the instruction book of the home network certified device.
- 2 Press **Home** on the remote control.
- 3 Use **Left/Right** to select **Home Network**.
  - This unit will start loading the home server list.
- 4 After loading, home server list will appear. Select a home server you want to access, then press **OK**.

## Guide to home network

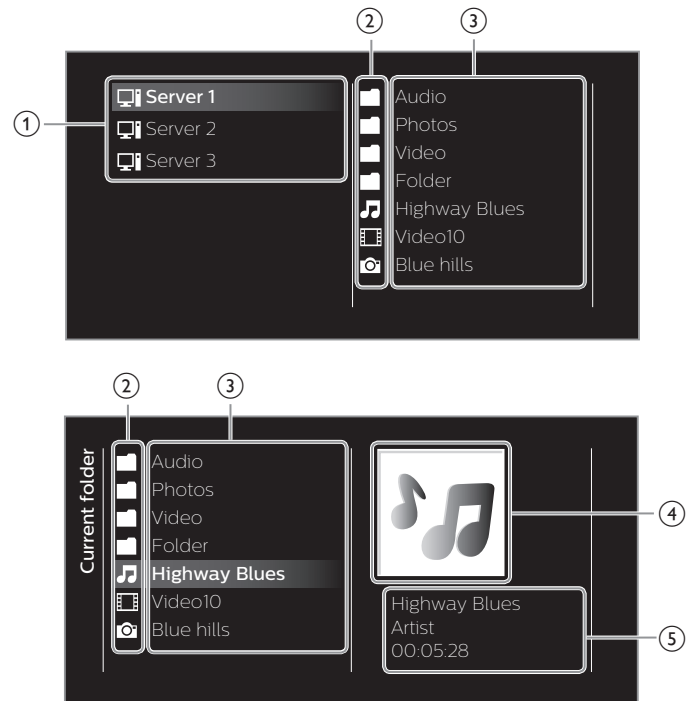

- ① Home server list
- ② Folder / media icon
- ③ Group (folder) / file list
- ④ Image
- ⑤ Current file info

## View your pictures using home network

- 1 Press ▲▼ to select a file or a folder.
- 2 Press **OK** or ►|| to start a slide show of the files.
  - Press **OK** or ►|| to pause the slide show. The || icon appears.
  - Press ◀◀ or ▶▶ to move between images.
  - Press ↵ **BACK** or ■ to stop the slide show.
  - Press □ **OPTIONS** to display the optional menu, then use ▲▼ to select the desired item.

Voice guide toggle *1	Off	Sets Voice guide to off.
	On	Sets Voice guide to on.
Repeat *2	Off	Sets repeat playback to off.
	One	Sets repeat playback for a selected image file.
	All	Sets repeat playback for all image files in the current folder.
Slide time *2	Short	Switches to the next image in 5 seconds.
	Medium	Switches to the next image in 10 seconds.
	Long	Switches to the next image in 15 seconds.
Transitions *2	None	No effect when switching images.
	Dissolve	Overlaps the next image on the current image.
	Wipe right	Pushes the current image out from left.
	Wipe left	Pushes the current image out from right.
	Wipe up	Pushes the current image out from bottom.
	Wipe down	Pushes the current image out from top.
	Box in	The next image comes to the center from the outside.
	Box out	The next image goes to the outside from the center.
Auto picture *2	Selects the picture mode according to your preference. (Standard, Natural, Vivid, Sports, Movie, Game, Energy saving and Internet video)	
Rotate *3	0	Displays an image in its original direction.
	90	Rotates an image 90 degrees clockwise.
	180	Rotates an image 180 degrees clockwise.
	270	Rotates an image 270 degrees clockwise.
Zoom *3	1X	Displays an image in its original size.
	2X	Magnifies a current image by 2 times.
	4X	Magnifies a current image by 4 times.

- \*1 Voice guide toggle is available in slide show and pause mode.
- \*2 You can set **Repeat**, **Slide time**, **Transitions** and **Auto picture** when images are in slide show.
- \*3 You can set **Rotate** and **Zoom** when slide show is in pause mode.

## Listen to music using home network

- 1 Press ▲▼ to select a file or a folder.
- 2 Press **OK** or ►|| to play the selected files.
  - Press **OK** or ►|| to pause, press **OK** or ►|| again to resume.
  - Press ▶▶ to skip up the next file.
  - Press ◀◀ to skip down the previous file.
  - Press ■ to stop playback.
  - Press □ **OPTIONS** to display the optional menu, then use ▲▼ to select the desired item.

Voice guide toggle *	Off	Sets Voice guide to off.
	On	Sets Voice guide to on.
Repeat	Off	Sets repeat playback to off.
	One	Sets repeat playback for a selected music file.
	All	Sets repeat playback for all music files in the current folder.
Shuffle	Off	Sets shuffle playback to Off.
	On	Sets shuffle playback for all music files in the current folder.
TV Speakers	Off	The sound will not be output from the unit's speakers.
	On	The sound will be output from the unit's speakers.
	Speakers EasyLink	You can control audio output from your connected EasyLink compliant devices with <b>VOL + / -</b> by using this unit's remote control.
Auto sound	Selects the sound mode according to your preference. (Standard, Vivid, Sports, Movie, Music and News)	

\* Voice guide toggle is available in slide show and pause mode.

## Watch videos using home network

- 1 Press ▲▼ to select a file or a folder.
- 2 Press OK or ►|| to play the selected files.
  - Press OK or ►|| to pause, press OK or ►|| again to resume.
  - Press ►► to fast-forward search.
  - Press ◀◀ to fast-backward search.
  - Press ■ to stop playback.
  - Press ►|| to resume from the point at which playback was stopped. Press OK to play from the beginning of the file at which playback was stopped.
  - Press CH + to play the next file.
  - Press CH - to play the current file at the beginning. Press CH - twice within 5 seconds to play the previous file.
  - Press OPTIONS to display the optional menu, then use ▲▼ to select the desired item.

Voice guide toggle *	Off	Sets Voice guide to off.
	On	Sets Voice guide to on.
Repeat	Off	Sets repeat playback to off.
	One	Sets repeat playback for a selected video file.
TV speakers	All	Sets repeat playback for all video files in the current folder.
	Off	The sound will not be output from the unit's speakers.
Auto picture	On	The sound will be output from the unit's speakers.
	Speakers EasyLink	You can control audio output from your connected EasyLink compliant devices with VOL + / - by using this unit's remote control.
Auto picture	Selects the picture mode according to your preference. (Standard, Natural, Vivid, Sports, Movie, Game, Energy saving and Internet video)	
Auto sound	Selects the sound mode according to your preference. (Standard, Vivid, Sports, Movie, Music and News)	

\* Voice guide toggle is available in slide show and pause mode.

### Note(s)

- The resume information will be kept even when the unit is Turned off.
- If you play another file while the previously viewed file is being resumed, the resume information of the previously viewed file will be deleted.
- The file or the folder in resume stop mode will be highlighted in gray on List or Thumbnails

## Net TV

Net TV offers internet services for your TV. Use the TV remote control to browse the Net TV pages. You can play movies, listen to music and much more, all from your TV screen.

- Because Net TV is an online system, it can be modified over time to better serve its purpose.
- Some Net TV services can be added, changed or stopped after some time.
- You cannot download and save files or install plug-ins.

### Before using Net TV

Follow the procedure below before using Net TV.

- 1 Connect this unit to the internet.
- 2 Set up the necessary network connection settings. (Refer to **Connect to network** → p. 37)

### Using Net TV

- 1 Press NETTV.
  - Net TV screen will appear, then use ▲▼◀▶ to select service icon.
  - For the first time only, Terms of Use screen will appear. After confirming the content, use ▲▼ to select **Agree**, then press OK.

### Guide to Net TV menu screen

Net TV start screen

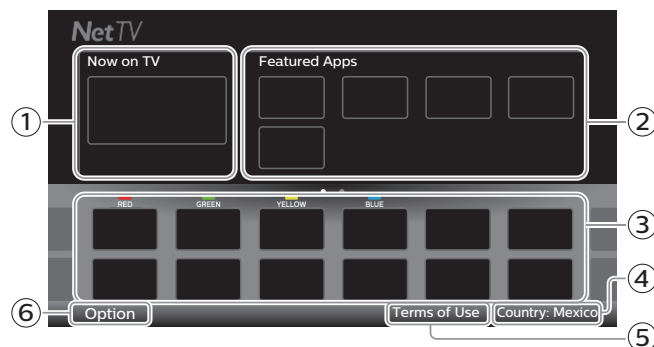

- |                 |   |
|-----------------|---|
| ① Now on TV     | : Displays the image of the input under present tuning. |
| ② Featured Apps | : Displays fixed net service icons.                     |
| ③ Selected Apps | : Displays movable net service icons.                   |
| ④ Country       | : Selects what country you live in.                     |
| ⑤ Terms of Use  | : Displays a copy of net service.                       |
| ⑥ Option        | : Remove or move App.                                   |

## My Apps functions

### Remove App

- 1 Use ▲▼◀▶ to select the desired App, then press **OPTIONS**.
- 2 Use ▲▼ to select **Remove App**, then press **OK**.
  - The selected App will be removed from **My Apps** list.

### Move App

- 1 Use ▲▼◀▶ to select the desired App, then press **OPTIONS**.
- 2 Use ▲▼ to select **Move App**, then press **OK**.
  - The selected App icon will be smaller.
- 3 Use ▲▼◀▶ to the point you want to place, then press **OK**.

## Guide to App Gallery

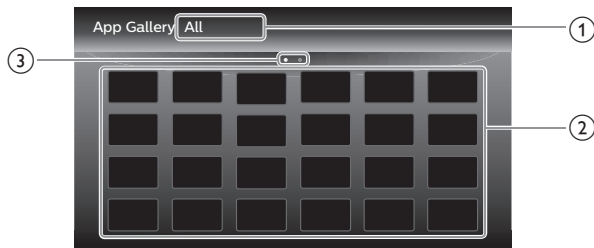

- |                  |  |
|------------------|--|
| ① Category menu: | List of category menu.   |
| ② Icon list:     | Displays unregistered net service icons on <b>My Apps</b> list.    |
| ③ Page guide:    | Displays the order of pages. The current page will be highlighted. |

- 1 Press **NETTV**, then use ▲▼◀▶ to select **App Gallery**.
- 2 Use ▲▼◀▶ to select the desired App in **My Apps** list, then press **OK**.
  - You can also choose from Category menu. Use ▲▼◀▶ to select **All**, then use ▲▼**OK** to select the desired category.
  - If you select **Add**, the selected App icon will be placed at the end of **My Apps** list.
  - If you select **Add and move**, the selected App icon will be smaller and use ▲▼◀▶ to the point you want to place, then press **OK**.

Even if you press **BACK** to cancel this function, the selected App icon will be placed at the end of **My Apps** list.

## Information on network services

For detailed information on 3rd party internet services, please visit the service providers website:

**Netflix** : <http://www.netflix.com>

For additional help, refer to the Frequently Asked Questions FAQs at [www.philips.com/support](http://www.philips.com/support).

Select TV and enter your model number.

# 5 Useful tips

## FAQ

Question	Answer
My remote control does not work. What should I do?	<ul style="list-style-type: none"> <li>• Check the antenna or cable connection to the main unit.</li> <li>• Check the batteries on the remote control.</li> <li>• Check if there is an obstacle between the infrared sensor window and the remote control.</li> <li>• Test the IR signal output use <b>IR signal check</b> → p. 51 If okay, then possible infrared sensor trouble.</li> <li>• Aim the remote control directly at the infrared sensor window on the front of the unit.</li> <li>• Reduce the distance to the unit.</li> <li>• Re-insert or replace the AAA batteries with their polarities (+/-) as indicated on the remote control battery area.</li> <li>• When there is an infrared-equipped device such as PC near this unit, it may interrupt the remote control signal on this unit. Move the infrared-equipped device away from this unit, change the angle of the device's infrared sensor or turn off the infrared communication function.</li> </ul>
How come the initial setup appears every time I turn on this unit?	<ul style="list-style-type: none"> <li>• Make sure to complete the initial setup before the unit goes into standby mode.</li> </ul>
Why can I not watch some RF signal TV programs?	<ul style="list-style-type: none"> <li>• Autoprogram must be completed when you set up the unit for the first time or move it to a location where previously unavailable channels are broadcast.</li> <li>• Make sure auto programming has been completed. → p. 34</li> <li>• The selected channel may not be broadcasting.</li> <li>• When Auto programming is interrupted and not completed, some channels will not be received. Make sure to complete the Autoprogram. → p. 34</li> <li>• The selected channel cannot be viewed by the <b>Child lock</b> setting. → p. 35</li> <li>• The unit requires some kind of antenna input. An indoor antenna (Digital or VHF / UHF), an external antenna (Digital or VHF / UHF) or an RF coaxial cable from your wall cable or set-top box needs to be plugged into the unit.</li> </ul>
How come there is no image from the connected external devices?	<ul style="list-style-type: none"> <li>• Check if the correct input mode is selected by pressing <b>SOURCE</b>. → p. 19</li> <li>• Check the antenna, cable or other input connection to the unit.</li> <li>• When using the component video connection check that the green (Y), blue (Pb/Cb) and red (Pr/Cr) connectors are connected to their corresponding colored jacks on the unit.</li> </ul>
When I enter a channel number, why does it change automatically?	<ul style="list-style-type: none"> <li>• Many digital channels have alternate channel numbers. The unit changes the numbers automatically to the ones signifying the broadcasting station's channel number. These basic numbers used for the previous analog broadcasts. (e.g., input digital ch# 30 automatically changes to digital ch# 8.1)</li> </ul>
Why are captions not displayed entirely? Or why are captions delayed behind the dialog?	<ul style="list-style-type: none"> <li>• Closed captions that are delayed a few seconds behind the actual dialog are common for live broadcasts. Most captioning production companies can display a dialog to maximum of 220 words per minute. If a dialog exceeds that rate, selective editing is used to insure that the closed captions remain up-to date with the current TV screen dialog.</li> </ul>
How can I set the clock?	<ul style="list-style-type: none"> <li>• There is no clock function on this unit.</li> </ul>
My PIN code no longer works, how can I change the child lock setting?	<ul style="list-style-type: none"> <li>• Although the default PIN code (0000) is supplied with the unit, the PIN code will be required once you set a PIN code in <b>Child lock</b> → p. 35 When you forget your PIN code, enter 07 11 in <b>Change PIN</b> to reset the PIN code. → p. 36</li> </ul>
When I start up the TV or a net service, a message appears on the screen prompting for software update again.	<ul style="list-style-type: none"> <li>• When you start up the TV or a net service after executing the software update, a message may appear on the screen prompting for software update again. In this case, please select <b>Update</b> to start USB update or network update. → p. 42</li> </ul>



## Troubleshooting tips

If the unit does not perform properly when operated as instructed in this manual,

**Please check the following Troubleshooting tips and all connections once before calling for service.**

### Power

#### No power

- Make sure the AC power cord is plugged in.
- Make sure that the AC outlet supplies the proper voltage, plug another electrical appliance into the AC outlet to ensure that the AC outlet operates normally.
- If a power failure occurs, unplug the AC power cord for 1 minute to allow the unit to reset itself.

### Remote

#### Control buttons do not work.

- Do NOT press more than one button at the same time.
- Ensure that no buttons on the remote control are depressed and move freely.

#### Universal remote control does not work properly.

- Refer to the User manual of the universal remote control for the Philips code.

### Picture

#### Power is on but no screen image.

- Check whether the connection for the antenna, cable or set-top box is connected correctly.
- Check whether all the cables to the unit are connected to the correct output jack on your separate device like Blu-ray disc / DVD recorder.
- Make sure that the selected input mode is connected to the working input jack.
- Check if your computer is NOT in sleep mode when the input mode on this unit is in PC mode. Tap any key on the computer keyboard to wake it up.
- Check if the correct input mode is selected by pressing **SOURCE**.

#### No color

- View other TV channels. The problem might be limited to the broadcasting station.
- Adjust **Color** in **Picture** settings. **→ p. 27**

#### Picture poor

- Adjust **Contrast** and **Brightness** in **Picture** settings. **→ p. 27**
- For the best picture quality, watch "High Definition" wide screen programs. If the HD content is not available, watch "Standard Definition" programs instead.

#### You see pixelation on the screen.

- When the capabilities of the unit exceed the capabilities of the digital broadcasting, the signal will be increased to match the capabilities of the display on the unit. This may cause pixelation, noise or trash.

#### Unusual picture appears and the TV does not operate.

- Press the power button first. If it does not solve, follow the procedure below.
  - 1 Press the buttons on the remote control in the order shown below.  
**▶→▲→▼→⏻**
  - 2 Unplug the AC power cord, then wait for 1 minute, and then plug it in again.

### Sound

#### No sound is heard when using the HDMI digital connection.

- Some HDMI cables and devices may not be compatible with the TV due to different HDMI specifications.

#### No sound, distorted sound or incorrect audio sound is heard when using the HDMI-DVI connections.

- Make sure that the analog audio signals from the HDMI-DVI device are connected to the analog audio input L/R jacks.
- When using Component analog video or Composite analog video, make sure that the analog audio (L/R) connectors are mounted into the audio (L/R) input jacks.

#### Sound intermittent or no sound.

- Check if the audio cable is connected into the unit correctly.

#### You switch to a different input and the volume changes.

- This unit will memorize the volume level from the last time you adjusted it.
- If the volume of the sound from another device is higher or lower, then the loudness will change.
- Make sure **Auto volume leveling** is set to **On**. **→ p. 29**

### Picture & Sound

#### No sound with distorted picture occurs when using the HDMI digital connection.

- Some HDMI cables and devices may not be compatible with the TV due to different HDMI specifications.

#### No picture or sound

- Check if the power is on.
- Check whether all the cables to the unit are connected to the correct output jack on your separate device like Blu-ray disc / DVD recorder.
- View other TV channels. The problem might be limited to the broadcasting station or weak signal strength.
- Unplug the AC power cord and wait for about 1 minute, then plug the AC power cord and turn on the unit again.
- Check whether the connection of the antenna or cable / satellite set-top box is connected correctly.
- Make sure that the selected input mode is connected to the working input jack.
- Check if your computer is NOT in sleep mode when the input mode of this unit is in PC mode. Tap any key on the keyboard to wake up your computer.
- Make sure that the sound is not muted. Press **MUTE** so that the volume bar and current volume level will appear on the TV screen.
- Make sure that the volume is NOT set to **0** or **MUTE**. If so, use **VOL + / -** to adjust to the desired volume.
- Make sure that the headphone is NOT connected to the headphone audio output jack.
- Make sure that the **TV speakers** is NOT set to **Off**.

#### Adjusted Picture or Sound settings are not effective every time the unit is turned on.

- You must set **Home** in **Location**. **→ p. 31** (Otherwise, the settings you adjusted will not be memorized after the unit goes into standby mode.)

#### You see a distorted picture or hear an unusual sound. (Analog TV - NTSC signal)

- You may be getting NTSC (Analog) TV signal (not HDTV signal) interference from electrical appliances, automobiles, motorcycles or fluorescent lights.
- Try moving the unit to another location to see if this is the cause of the problem.

#### Ghosts, lines or streaks in picture.

- Electrical interference from nearby appliances may affect picture quality.
- View other TV channels. The problem might be limited to the broadcasting station or weak signal strength.

#### Picture poor, sound intermittent or no sound

- View other TV channels. The problem might be limited to the broadcasting station or weak signal strength.

### Child and rating lock

#### Forgotten PIN code.

- Enter "0711" to clear your password.

### Screen

#### You switch to a different input and the screen size changes.

- This unit will memorize the viewing mode from the last time you used the particular input modes.

#### The display image does not cover the entire screen.

- If you are using the unit as a PC monitor, make sure that **Horizontal position** and **Vertical position** in **Picture** are set correctly. **→ p. 27**
- If you are watching TV or using the Composite video, Component video or HDMI with 480i input, press **FORMAT** repeatedly to switch to various screen modes.

#### Different color marks on the TV screen

- View other TV channels. The problem might be limited to the broadcasting station, missing data or pixelation due to weak signal strength.

**Closed captions**

**Closed captions are displayed as a white box. No closed captions are displayed in the closed captions-supported program.**

- Interference from buildings or weather conditions may cause closed captions to be incomplete if watching analog TV signals.
- Broadcasting station may shorten the program to insert advertisements. The closed caption decoder cannot read the information of the shortened program.

**Black box is displayed on the TV screen.**

- The text mode is selected for caption. Select **CC-1**, **CC-2**, **CC-3** or **CC-4**.

**Software update**

**A message appears on the screen prompting for software update again.**

- When you start up the TV or a net service after executing the software update, a message may appear on the screen prompting for software update again. In this case, please select **Update** to start USB update or network update. ➔ p. 42

**Network**

**Cannot connect to the network.**

- Check if the Ethernet cable connection is properly made. Turn on the broadband router and/or modem.
- Check the network settings.
- Check if the broadband router and/or modem is correctly connected.

**Sometimes video quality is poor when using the wireless LAN.**

- The wireless network connection quality varies depending on the distance or obstacles (e.g. wall, basement, 2nd floor) between the TV wireless LAN adapter and the wireless router (access point), from other wireless networks, and brand and type of the wireless router (access point). When using the wireless LAN of the TV, it is suggested to place the wireless router as close as possible to the television.

**Wireless LAN connection fails or wireless connection is poor.**

- Check the installation location of the TV and wireless router (access point). Signal quality may be affected for the following reasons.
  - Interference of other wireless devices, microwaves, fluorescent lights, etc., are placed nearby.
  - There are floors or walls between the wireless router and TV.
  - If the problems continue even after checking the above, try making a wired LAN connection.

**Cannot use the wireless connection.**

- Check if the wireless LAN Access Point (AP) (e.g. wireless router) is oriented properly or not placed too close between them.
- Once you have activated the wireless connection please wait 30 seconds for the connection to be established after turning on the unit, before trying to access network features such as Net TV.

**Cannot use Netflix feature.**

- Check if the network connection is properly made.
- Visit <http://www.netflix.com> on your PC and become a Netflix member.
- Some network services may not be available in your country.

**Cannot add movies or TV episodes to the Instant Queue.**

- Visit [www.netflix.com](http://www.netflix.com) on your PC.

**Even though the speed of the internet connection improves during playback, the picture quality of Netflix streaming movie does not improve.**

- The picture quality does not change during playback. It differs depending on the speed of internet connection at the time of loading.

**The picture quality of a streaming movie (Netflix) is poor.**

- Check the speed of your internet connection. You need speeds of at least 8Mbps to this player for high quality uninterrupted playback.

**Streaming movie (Netflix) often stops or starts buffering during playback.**

- Contact your internet service provider to troubleshoot your internet connection for speed and line quality. Consistent line quality and speed are very important for internet video playback.

**Cannot connect to the network while my PC is connected to the network.**

- Check the content of your internet service contract to see if your internet service provider prevents multiple terminals connecting at the same time.

**Cannot use Easy Connect to connect to the access point.**

- Connect the unit to the access point using scan or manual entry mode. If the access point's security mode is set to WEP\*, change the setting to others (recommended), then try Easy connect again. (For access point configuration, please consult its user manual or manufacturer.)

\* WEP is not recommended to be used due to its major security flaws. Change the security protocol on the wireless router to others (recommended) mode.

**Folder or files stored on home network media server are not displayed in the file list or cannot be played back.**

- Check the setting on your home media server. (Refer to the user manual of the home media server.)
- Check the network connection and settings.

**Note(s)**

- The LCD screen is manufactured to provide many years of useful life. Occasionally a few non active pixels may appear as a fixed point of blue, green or red. This is not to be considered a defect in the LCD screen.
- Some functions are not available in specific modes, but this is not a malfunction. Read the description in this manual for more details on correct operations.

For additional troubleshooting, refer to the Frequently Asked Questions or FAQs on [www.philips.com/support](http://www.philips.com/support).

# 6 Information

## Glossary

### Analog TV (NTSC)

Acronym that stands for National Television Systems Committee and the name of analog broadcasting standards. Off the air analog TV signals are no longer being sent by major broadcasting stations in the USA.

### ARC (Audio Return Channel) (HDMI 2 only)

HDMI-ARC allows you to use Philips EasyLink to output TV audio directly to a connected audio device, without the need for an additional digital audio cable. Be sure that the device is HDMI CEC and ARC compliant, and that the TV is connected to the device using an HDMI cable attached to both HDMI-ARC connectors.

### Aspect ratio

The width of a TV screen relative to its height. Conventional TVs are 4:3 (in other words, the TV screen is almost square); widescreen models are 16:9 (the TV screen is almost twice as wide as its height).

### CEC (Consumer Electronics Control)

This allows you to operate the linked functions between our brand devices with CEC feature and this unit. We do not guarantee 100% interoperability with other brands of CEC compliant devices.

### Component video

This is a Video signal format that conveys each of 3 principal colors of light (red, blue and green) through different signal lines. This allows the viewers to experience picture colors as original as it is. There are several signal formats, including Y / Pb / Pr and Y / Cb / Cr.

### Dolby Digital

The system developed by Dolby Laboratories to compress digital sound. It offers stereo sound (2ch) or multi-channel audio.

### DTV (ATSC)

Abbreviation that stands for Advanced Television Systems Committee and the name of the digital broadcasting standards.

### E-sticker

E-sticker is showing set features, technical information, etc on this TV set that is displayed on the TV screen mainly used by TV retailers. Previously the information was on a printed sticker that was put on the display.

### HDMI (High-Definition Multimedia Interface)

Interface that supports all uncompressed, digital audio / video formats including set-top box, Blu-ray / DVD recorder or digital television, over a single cable.

### HDTV (High-Definition TV)

Ultimate digital format that produces high resolution and high picture quality.

### PIN code

A stored 4-digit number that allows access to parental control features.

### SAP (Secondary Audio Program)

Second-audio channel delivered separately from the Main-audio channel. This audio channel is used as an alternate in bilingual broadcasting.

### SDTV (Standard Definition TV)

Standard digital format that is similar to the analog TV picture quality.

### Sonic Emotion Premium

Sonic Emotion Premium fills your surroundings with the right ambience, clarifies voice, and details the sound stage, making your experience more immersive and enjoyable.

## Maintenance

### Cleaning

- Clean the front panel and other exterior surfaces of the unit with a soft microfiber cloth or lens brush. Before cleaning the panel, disconnect the AC power cord.
- Never use a solvent or alcohol. Do not spray insecticide liquid near the unit. Such chemicals may cause damage and discoloration to the exposed surfaces.
- Do not spray any liquids on the screen or other exterior surfaces of this unit. If liquids enter the unit, they could cause shorts, electric shocks or fire damage.

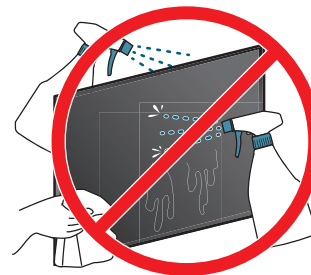

### Servicing

Should your unit become inoperative, do not try to correct the problem yourself. There are no user serviceable parts inside. Call our toll free customer support line found on the cover of this User manual to locate an authorized service center.

### IR signal check

If the remote control is not working properly, you can use a digital or cell phone camera to see if it is sending out an infrared signal.



e.g.) With a digital camera:

Point the digital camera towards the remote control infrared diode at the front of the remote control. Press and hold any key on the remote control and look at the camera display. If an infrared pulsating light appears on the display, the remote control is sending out an IR signal.

**Note:** Some cameras may have an IR filter or dual camera cell phones may have an IR filter in one of the camera's and both will not display the IR signal.

# 7 Specifications

Model #		32PFL4902
<b>Picture</b>		
Type	WXGA (1366 x 768 pixels 60Hz)	
Diagonal screen size / Aspect ratio	31.5" / 16:9	
Viewing angles	178° (V) by 178° (H)	
Built-in digital / analog tuner	ATSC (digital) / NTSC (analog)	
<b>Sound</b>		
Mono / Stereo	Mono, Stereo, Sonic Emotion Premium	
Power output (RMS watts)	8W x 2	
Equalizer	5 band	
<b>Ease of use</b>		
Picture format	SD (4:3 source)	Automatic / Super zoom / 4:3 / Movie expand 14:9 / Movie expand 16:9 / Wide screen
	HD (16:9 source)	Automatic / 4:3 / Wide screen / Unscaled or Full
Photo slide show	JPEG, Progressive JPEG	
Music playback	MP3, WAV, AAC	
Video playback	MPEG1, MPEG2, H.264, MPEG4, H.265/HEVC	
<b>Channel</b>		
Channel coverage	Over-the-Air DTV : VHF: 2~13 (ATSC) UHF: 14~69 (Each channel may have e.g. 2.1~2.9, 3.1~3.9, etc)	
	Over-the-Air Analog : VHF: 2~13 (NTSC) UHF: 14~69	
CATV (Analog NTSC)	2~13, A~W W+1~W+94 (Analog W+1~W+84), A-5~A-1, 5A	
Tuning system	Channel frequency synthesized tuning system	
Channel access	Direct access number keyboard, Programmable scan, Channel +(up) / -(down) and PREV. CH (Previous channel)	
<b>Connectivity</b>		
Component video input (Y/Pb/Pr)	1 Supporting video signals : 480i/p, 720p, 1080i/p @60Hz	
Composite video input (Shared Y green terminal with component video)	1	
HDMI input	2	
	Supporting HDMI video signals : 480i/p, 720p, 1080i @60Hz, 1080p @24/30/60Hz	
	Supporting HDMI digital audio signals : LPCM, AC3, DD+ Supporting PC-input video signal up to FHD (1920 x 1080)	
Analog audio L/R input	1 (L audio / R audio)	
PC input	Via HDMI and HDMI-DVI + Analog audio L/R	
USB	1	
Wireless LAN	Supporting wireless standards : IEEE 802.11 b/g/n (2.4GHz)	
Ethernet port	1	
Digital audio output	1 Supporting Dolby Audio (Dolby Digital and Dolby Digital Plus)	
Headphone output	1 3.5mm (1/8 inch)	
<b>Power</b>		
Power requirements	120V~ +/- 10%, 50/60Hz +/- 0.5%	
<b>Temperature</b>		
Operating temperature	41 °F (5 °C) to 104 °F (40 °C)	

• Specifications are subject to change without prior notice.

# 8 Warranty

## POLIZA DE GARANTÍA

### ESTA PÓLIZA ES GRATUITA

Este aparato ha sido cuidadosamente diseñado y se ha fabricado con los mejores materiales bajo un estricto control de calidad, garantizando su buen funcionamiento por los periodos establecidos según el aparato (ver lista en la parte inferior) **a partir de la entrega del aparato al consumidor.**

**Esta póliza incluye la reparación o reposición gratuita de cualquier parte o componente que eventualmente fallase y la mano de obra necesaria para su reparación, así como los gastos de transportación razonablemente erogados dentro de nuestro centro de servicio, misma que se hará efectiva en cualquiera de nuestros centros de servicio autorizados en el país.**

Si tu aparato llegase a requerir de nuestro servicio de garantía, acuda al centro de servicio más cercano a su domicilio, de tener alguna duda por favor llame a nuestro **CENTRO DE INFORMACIÓN AL CLIENTE LADA** sin costo en toda la republica al **01 800 839 19 89** en donde con gusto le indicaremos el centro de servicio autorizado más cercano a su domicilio.

P&F MEXICANA S.A. de C.V. a través de sus centros de servicio autorizados **reparará y devolverá a usted su aparato en un plazo no mayor a 20 días hábiles** contados a partir de la fecha de ingreso, impresa en la orden de servicio de cualquiera de nuestros centros de servicio autorizados.

**La garantía de esta póliza cubre cualquier desperfecto o daño eventualmente ocasionado por los trabajos de reparación y/o traslado del aparato en el interior de nuestros centros de servicio autorizados.**

**Esta póliza sólo tendrá validez, si está debidamente requisitada, sellada por la casa vendedora, en caso de extravío de esta póliza, podrá hacer efectiva su garantía con la presentación de su factura de compra.**

### ESTA PÓLIZA NO SE HARÁ EFECTIVA EN LOS SIGUIENTES CASOS:

- Cuando el aparato sea utilizado en condiciones distintas a las normales.
- Cuando el aparato no haya sido operado de acuerdo con el instructivo de uso que se le acompaña.
- Cuando la causa de la falla o mal funcionamiento sea consecuencia de una reparación inadecuada o alteración producida por personas no autorizadas por P&F MEXICANA S.A.de C.V.

### PERIODOS DE GARANTÍA

12 meses. – Televisores, Reproductores de discos de video digital DVD, Reproductores de disco de video digital BLU-RAY, Barras de Sonido.



# License

P&F Mexicana, S.A. de C.V. hereby offers to deliver, upon request, a copy of the complete corresponding source code for the copyrighted open source code packages, on an "AS IS" basis, used in this product for which such offer is requested by the respective licenses. This offer is valid up to three years after the product purchase to anyone in receipt of this information. To obtain source code, please contact P&F USA, Inc. You should write to "Open Source Team, P&F USA, Inc., PO Box 2248, Alpharetta, GA 30023-2248. P&F USA, Inc. disclaims any and all warranties and representations with respect to such software and related source code including quality, reliability, usability, and accuracy, and further disclaim all express, implied, statutory or otherwise, including without limitation, any implied warranties of title, non-infringement, merchantability, or fitness for a particular purpose. P&F Mexicana, S.A. de C.V. shall not be liable to make any corrections to the open source software or source code or to provide any support or assistance with respect to it. P&F Mexicana, S.A. de C.V. disclaims any and all liability arising out of or in connection with the use of this software and/or source code.



P&F Mexicana, S.A. de C.V.  
Av. La Palma No. 6, Col. San Fernando La Herradura.  
Huixquilucan, Edo. de México. C.P. 52787

This product has been manufactured by and is sold under the responsibility of P&F Mexicana, S.A. de C.V., and P&F Mexicana, S.A. de C.V. is the warrantor in relation to this product.

The Philips trademark and the Philips Shield Emblem are registered trademarks of Koninklijke Philips N.V. used under license.

AA1F2MG-32HB  
★★★★★