

**PHILIPS**

Televisions

6775/4775 series

50PFL6775/F8

55PFL6775/F8

40PFL4775/F8



User Interface may vary.  
(es) La Interfaz del usuario puede variar.

Register your product and get support at

[www.philips.com/welcome](http://www.philips.com/welcome)

---

EN User manual

---

ES Manual del usuario

EN For further assistance, call the customer support service in your country.

- To obtain assistance, contact Philips customer care center; Mexico city and metropolitan area; (55)5887 9736  
Interior de la republica; (800) 8391 989

ES Para obtener más información, llame al centro de atención a clientes de su país.

- Para obtener asistencia, póngase en contacto con el CENTRO DE INFORMACION AL CLIENTE, CDMX y Area metropolitana; (55) 5887 9736  
Interior de la republica; (800) 8391 989

LEA CUIDADOSAMENTE ESTE INSTRUCTIVO ANTES DE USAR SU APARATO

EN

# Safety instruction

Register online at [www.philips.com/welcome](http://www.philips.com/welcome) today to get the most benefits from your purchase.

Registering your model with Philips makes you eligible for all of the valuable benefits listed below, so don't miss out.

Register online at [www.philips.com/welcome](http://www.philips.com/welcome) to ensure:

## \*Product safety notification

By registering your product, you'll receive notification - directly from the manufacturer - in the rare case of a product recall or safety defect.

## \*Additional benefits

Registering your product guarantees that you'll receive all of the privileges to which you're entitled, including special money-saving offers.

## Know these *safety* symbols



**CAUTION**  
**RISK OF ELECTRIC SHOCK**  
**DO NOT OPEN**



CAUTION: TO REDUCE THE RISK OF ELECTRIC SHOCK, DO NOT REMOVE COVER (OR BACK). NO USER-SERVICEABLE PARTS ARE INSIDE. REFER SERVICING TO QUALIFIED SERVICE PERSONNEL.

The caution marking is located on the rear or bottom of the cabinet.



The lightning flash with arrowhead symbol, within an equilateral triangle, is intended to alert the user to the presence of uninsulated "dangerous voltage" within the apparatus's enclosure that may be of sufficient magnitude to constitute a risk of electric shock to persons.



The exclamation point within an equilateral triangle is intended to alert the user to the presence of important operating and maintenance (servicing) instructions in the literature accompanying the apparatus.

## WARNING:

To reduce the risk of fire or electric shock, do not expose this apparatus to rain or moisture. Apparatus shall not be exposed to dripping or splashing and no objects filled with liquids, such as vases, shall be placed on the apparatus.

## CAUTION:

To prevent electric shock, match wide blade of plug to wide slot, fully insert.

**PHILIPS**

For fastest support visit us online for chat and self service solutions at [www.philips.com/support](http://www.philips.com/support)

# CHILD SAFETY:

## PROPER TELEVISION PLACEMENT MATTERS

### THE CONSUMER ELECTRONICS INDUSTRY CARES

- Manufacturers, retailers and the rest of the consumer electronics industry are committed to making home entertainment safe and enjoyable.
- As you enjoy your television, please note that all televisions – new and old- must be supported on proper stands or installed according to the manufacturer's recommendations. Televisions that are inappropriately situated on dressers, bookcases, shelves, desks, speakers, chests, carts, etc., may fall over, resulting in injury.

### TUNE IN TO SAFETY

- **ALWAYS** follow the manufacturer's recommendations for the safe installation of your television.
- **ALWAYS** read and follow all instructions for proper use of your television.
- **NEVER** allow children to climb on or play on the television or the furniture on which the television is placed.
- **NEVER** place the television on furniture that can easily be used as steps, such as a chest of drawers.
- **ALWAYS** install the television where it cannot be pushed, pulled over or knocked down.
- **ALWAYS** route cords and cables connected to the television so that they cannot be tripped over, pulled or grabbed.

### WALL OR CEILING MOUNT YOUR TELEVISION

- **ALWAYS** contact your retailer about professional installation if you have any doubts about your ability to safely mount your television.
- **ALWAYS** use a mount that has been recommended by the television manufacturer and has a safety certification by an independent laboratory (such as UL, CSA, ETL).
- **ALWAYS** follow all instructions supplied by the television and mount manufacturers.
- **ALWAYS** make sure that the wall or ceiling where you are mounting the television is appropriate. Some mounts are not designed to be mounted to walls and ceilings with steel studs or cinder block construction. If you are unsure, contact a professional installer.
- Televisions can be heavy. A minimum of two people is required for a wall or ceiling mount installation.

### MOVING AN OLDER TELEVISION TO A NEW PLACE IN YOUR HOME

- Many new television buyers move their older CRT televisions into a secondary room after the purchase of a flat-panel television. Special care should be made in the placement of older CRT televisions.
- **ALWAYS** place your older CRT television on furniture that is sturdy and appropriate for its size and weight.
- **NEVER** place your older CRT television on a dresser where children may be tempted to use the drawers to climb.
- **ALWAYS** make sure your older CRT television does not hang over the edge of your furniture.

# Important safety instructions

1. Read these instructions.
2. Keep these instructions.
3. Heed all warnings.
4. Follow all instructions.
5. Do not use this apparatus near water.
6. Clean only with dry cloth.
7. Do not block any ventilation openings. Install in accordance with the manufacturer's instructions.
8. Do not install near any heat sources such as radiators, heat registers, stoves, or other apparatus (including amplifiers) that produce heat.
9. Do not defeat the safety purpose of the polarized or grounding-type plug. A polarized plug has two blades with one wider than the other. A grounding type plug has two blades and a third grounding prong. The wide blade or the third prong are provided for your safety. If the provided plug does not fit into your outlet, consult an electrician for replacement of the obsolete outlet.
10. Protect the power cord from being walked on or pinched particularly at plugs, convenience receptacles, and the point where they exit from the apparatus.
11. Only use attachments / accessories specified by the manufacturer.
12. Use only with the cart, stand, tripod, bracket, or table specified by the manufacturer, or sold with the apparatus. When a cart is used, use caution when moving the cart / apparatus combination to avoid injury from tip-over.
13. Unplug this apparatus during lightning storms or when unused for long periods of time.
14. Refer all servicing to qualified service personnel.  
Servicing is required when the apparatus has been damaged in any way, such as power-supply cord or plug is damaged, liquid has been spilled or objects have fallen into the apparatus, the apparatus has been exposed to rain or moisture, does not operate normally, or has been dropped.



## Note to the CATV system installer:

This reminder is provided to call the CATV system installer's attention to Article 820-40 of the NEC that provides guidelines for proper grounding and, in particular, specifies that the cable ground shall be connected to the grounding system of the building, as close to the point of cable entry as practical.

## Example of antenna grounding as per NEC - National Electric Code

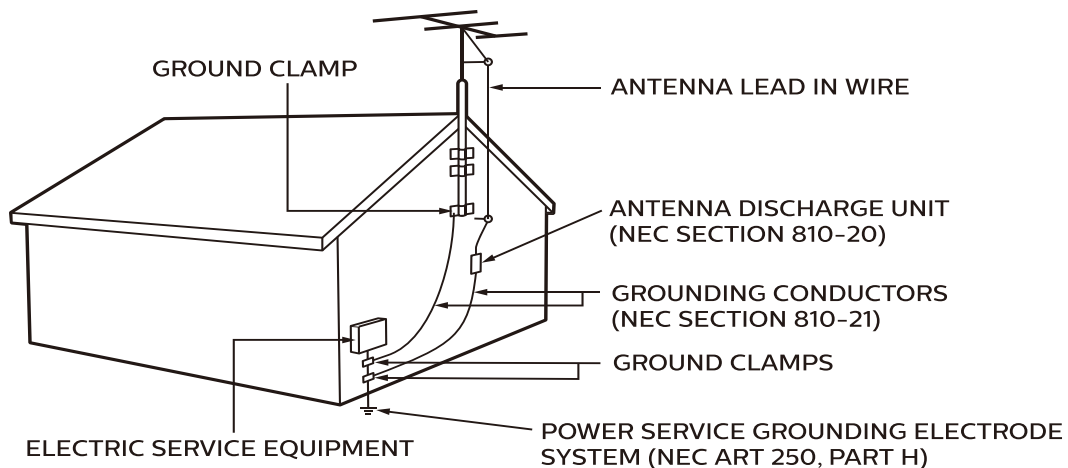



## Wall mount bracket kit

Model	Screw dimension
40PFL4775/F8	M6 x12mm
50PFL6775/F8	M6 x12mm
55PFL6775/F8	M6 x15mm

- Your TV meets the VESA standard for wall mounting. Consult with your local dealer for a wall mount bracket which is compatible with your TV model.
- The recommended wall mount bracket kit (sold separately) allows the mounting of the TV on the wall.
- For detailed information on installing the wall mount, refer to the wall mount instruction book.
- Funai Corporation is not responsible for any damage to the product or injury to yourself or others if you elect to install the TV wall mount bracket or mount the TV onto the bracket on your own.
- The wall mount bracket must be installed by experts.

### **P&F Mexicana S.A. de C.V. is not liable for any accidents or injuries incurred while installing this product, including but not limited to those noted below:**

- Install the wall mount bracket on a sturdy vertical wall.
- If installed onto a ceiling or slanted wall, the TV and wall mount bracket may fall which could result in a severe injury.
- Do not use screws that are longer or shorter than their specified length. If screws too long are used this may cause mechanical or electrical damage inside the TV set. If screws too short are used this may cause the TV set to fall.
- Do not fasten the screws by excessive force. This may damage the product or cause the product to fall, leading to an injury.
- For safety reasons use 2 people to mount the TV onto a wall mounting bracket.
- Do not mount the TV onto the wall mounting bracket while your TV is plugged in or turned on. It may result in an electrical shock injury.

### **When installing the unit on the wall, allow this much space.**

**Top** : 11.8 inches (30cm)  
**Left and right side**: 5.9 inches (15cm)  
**Bottom** : 3.9 inches (10cm)

#### PARA SU USO EN MEXICO:

La operación de este equipo está sujeta a las siguientes dos condiciones;

1. Es posible que éste equipo ó dispositivo no cause interferencia prejudicial.
2. Este equipo ó dispositivo debe aceptar cualquier interferencia, incluyendo la que pueda causar su operación no deseada

# Notice

Trademarks are the property of Koninklijke Philips N.V. or their respective owners. P&F Mexicana S.A. de C.V. reserves the right to change products at any time without being obliged to adjust earlier supplies accordingly.

The material in document is believed adequate for the intended use of the system. If the product or its individual modules or procedures are used for purposes other than those specified herein, confirmation of their validity and suitability must be obtained.

P&F Mexicana S.A. de C.V. warrants that the material itself does not infringe any United States patents. No further warranty is expressed or implied.

P&F Mexicana S.A. de C.V. cannot be held responsible neither for any errors in the content of document nor for any problems as a result of the content in document. Errors reported to P&F Mexicana S.A. de C.V. Corporation will be adapted and published on the Funai Corporation support website as soon as possible.

## Pixel characteristics

This LCD product has a high number of color pixels. Although it has effective pixels of 99.999% or more, black dots or bright points of light (red, green or blue) may appear constantly on the screen. This is a structural property of the display (within common industry standards) and is not a malfunction.

## Warranty

No components are user serviceable. Do not open or remove covers to the inside of the product. Repairs may only be done by service centers and official repair shops. Failure to do so shall void any warranty, stated or implied.

Any operation expressly prohibited in document, any adjustments or assembly procedures not recommended or authorized in document shall void the warranty.

## Positioning the TV

- Large screen TVs are heavy. 2 people are required to carry and handle a large screen TV.
- Make sure to hold the upper and bottom frames of the unit firmly as illustrated.
- Install the unit in a horizontal and stable position.
- Do not install the unit in direct sunlight or in a place subject to dust or strong vibration.
- Depending on the environment, the temperature of this unit may increase slightly. This is not a malfunction.
- When installing this unit in a temperate environment, avoid a place with rapid temperature changes.
- This unit should not be used in a tropical environment as it has not been evaluated under such conditions.
- No objects should be placed directly on or under this unit, especially lighted candles or other flaming objects.
- Depending on your external devices, noise or disturbance of the picture and / or sound may be generated if the unit is placed too close to them. In this case, please ensure enough space between the external devices and the unit.
- Do not insert the AC power cord into the power socket outlet before all the connections are made.
- Ensure that you always have easy access to the AC power cord and outlet to disconnect the TV from the AC outlet.
- Before you move the TV, disconnect attached cables to prevent damage to connectors, especially the TV tuner.
- Be sure to unplug the AC power plug from the AC outlet before moving or carrying the unit.

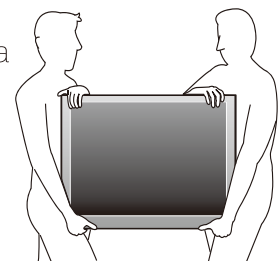

- When moving the TV and then setting it down, please be careful not to pinch the AC power cord under the unit.

## Regulatory notices

**WARNING:** To prevent injury, this apparatus must be securely attached to the furniture / wall in accordance with the instructions.

Tipping, shaking or rocking the unit may cause injury / death.

**WARNING:** Never place a TV in an unstable location. A TV may fall, causing serious personal injury or death. Many injuries, particularly to children, can be avoided by taking simple precautions such as:

- Using cabinets or stands recommended by the manufacturer of the TV.
- Only using furniture that can safely support the TV.
- Ensuring the TV is not overhanging the edge of the supporting furniture.
- Not placing the TV on tall furniture (for example, cupboards or bookcases) without anchoring both the furniture and the TV to a suitable support.
- Not placing the TV on cloth or other materials that may be located between the TV and supporting furniture.
- Educating the children about the dangers of climbing on furniture to reach the TV or its controls.

If your existing TV is being retained and relocated, the same considerations as above should be applied.

Do not place the unit on the furniture that is capable of being tilted by a child and an adult leaning, pulling, standing or climbing on it. A falling unit can cause serious injury or even death. In order to avoid interruption of ventilation, this unit should not be placed in built-in equipment such as a book cabinet, rack, etc., and the vents of this unit should not be covered with anything such as a tablecloth, curtain, newspaper, etc. Make sure that there is enough ventilation space (4 inches / 10 cm or more) around this unit.

Press  to turn the unit on and go into standby mode. To completely turn off the unit, you must unplug the AC power plug from the AC power outlet.

Disconnect the AC power plug to shut the unit off when trouble is found or not in use. The AC plug shall remain readily available.

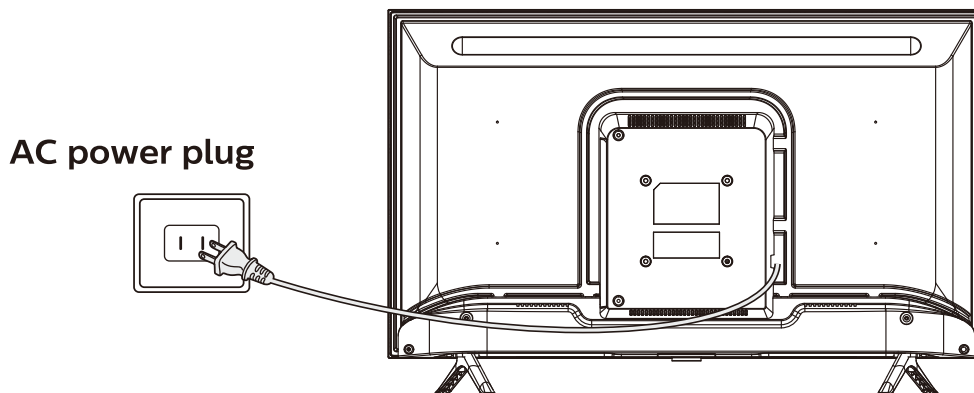

Never use a gas duster on this TV.

The gas trapped inside of this unit may cause ignition and explosion.

## Environmental care



The packaging of this product is intended to be recycled.  
Contact your local authorities for information about how to recycle the packaging.

## End of life directives

Philips pays a lot of attention to produce environmental-friendly products in green focal areas. Your new TV contains materials which can be recycled and reused. At the end of its life, specialized companies can dismantle the discarded TV to concentrate the reusable materials and to minimize the amount of materials to be disposed of. Please ensure you dispose of your old TV according to local regulations.

## ⚠ Batteries usage

**CAUTION:** Danger of explosion if battery is incorrectly replaced. Replace only with the same or equivalent type.

**WARNING:** Batteries (battery pack or battery installed) should not be exposed to excessive heat such as sunshine, fire or the like.

- Do not mix old and new batteries.
- Do not mix alkaline, standard (carbon-zinc) or rechargeable (ni-cad, ni-mh, Li-ion, etc.) batteries.

## Disposal of used batteries

The batteries supplied do not contain the heavy metals mercury and cadmium, however in certain localities, disposing batteries with household waste is not permitted. Please ensure you dispose of batteries according to local regulations.

## Downloading an electronic copy

To obtain a more detailed electronic copy of document:

1. Point your browser to : [www.philips.com/support](http://www.philips.com/support)
2. Choose your country of location with language.
3. Enter the product name or number in the search field. Alternatively, you can browse the catalog.
4. Click the description or model.
5. Under product support, click "User manual".

## Preparing to move / ship the unit

Please pack the unit properly by following the diagram on the carton (as noted below).

- To avoid damage to the screen, do not pack the stand on the same side as the TV screen, refer to the illustration.

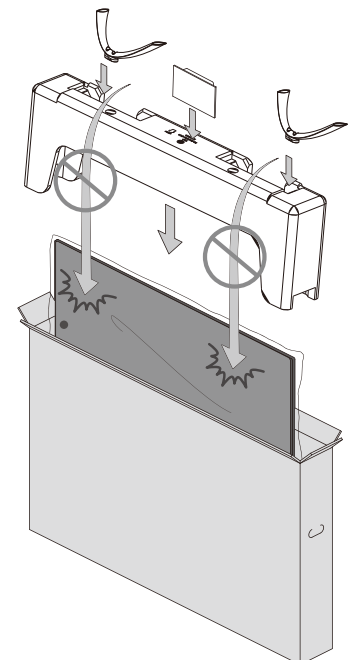

## Copyright

All other registered and unregistered trademarks are the property of their respective owners.



The terms HDMI and HDMI High-Definition Multimedia Interface, and the HDMI Logo are trademarks or registered trademarks of HDMI Licensing Administrator, Inc. in the United States and other countries.



Manufactured under license from Dolby Laboratories. Dolby, Dolby Audio, and the double-D symbol are trademarks of Dolby Laboratories.

Portions of this software are copyright © The FreeType Project ([www.freetype.org](http://www.freetype.org))

The American Academy of Pediatrics discourages television viewing for children younger than two years of age.

Some features may require an always-on broadband internet connection, firmware update and / or a minimum bandwidth. Internet services vary by location.

P&F MEXICANA, S.A.de C.V. does not warrant access to the portal or to any of the services, content, software and advertising. P&F MEXICANA, S.A. de C.V. or third party content / service providers may, in its sole discretion, add or remove access to any specific services, content, software and advertising at any time. Although P&F MEXICANA, S.A. de C.V. will strive to provide a good selection of services, content or software, P&F MEXICANA, S.A. de C.V. does not warrant continued access to any specific services, and content or software. P&F MEXICANA S.A. de C.V. does not warrant screen mirroring compatibility with all source devices such as smartphones, tablets, laptops, etc. due to large variability in, hardwarefirmware, drivers, software and implementation of wireless casting applications on these source devices. Although P&F MEXICANA S.A. de C.V. will strive to enhance compatibility and performance across a range of source devices, P&F MEXICANA S.A. de C.V. does not warrant compatibilitywith specific source devices.

## TELEVISOR A COLOR DE CRISTAL LIQUIDO (LCD)

MODELO	LCD	IMAGEN VISIBLE	ENERGIA
40PFL4775/F8	40" ( 101.60cm )	100.33cm	120V ~ 50/60Hz 60W
50PFL6775/F8	50" (127.00cm )	125.73cm	120V ~ 50/60Hz 120W
55PFL6775/F8	55" (139.70cm )	138.78cm	120V ~ 50/60Hz 130W

Comercializado por: P&F MEXICANA S.A.De C.V.

IMPORTADOR: P&F MEXICANA S.A.De C.V.

Av. Jaime Balmes No.11 Torre A Piso 1, Col. Polanco,

I Sección, Miguel Hidalgo. Ciudad de Mexico C.P. 11510 Tel: (55) 1328 5220



**GARANTIA INCLUIDA EN EL INSTRUCTIVO DE USO**

**HECHO EN: MEXICO**

## Copyright

© 2020 Roku, Inc. All rights reserved. ROKU, the ROKU Logo, and “NOW THIS IS TV” are trademarks and/or registered trademarks of Roku, Inc. Material in this User Manual is the property of Roku, Inc., and is protected under US and International copyright and/or other intellectual property laws. Reproduction or transmission of the materials, in whole or in part, in any manner, electronic, print, or otherwise, without the prior written consent of Roku, Inc., is a violation of Roku, Inc.’s, rights under the aforementioned laws.

No part of this publication may be stored, reproduced, transmitted or distributed, in whole or in part, in any manner, electronic or otherwise, whether or not for a charge or other or no consideration, without the prior written permission of Roku, Inc.

Requests for permission to store, reproduce, transmit or distribute materials shall be made to both of the following address:

Roku, Inc.  
150 Winchester Circle  
Los Gatos, CA 95032

Product name: Roku TV™  
Document name: Roku TV™ User Guide  
Document revision: 9.2.3 - Mexico, Spanish  
Publication date: 20 April 2020



# Contents

Welcome .....	1
The new standard in Smart TVs .....	1
Get the most out of your new TV .....	1
Connections and setup .....	5
Connecting an antenna, cable, or satellite box .....	5
Connecting external equipment with a composite AV video cable .....	6
Connecting external equipment with an HDMI® cable .....	6
Connecting headphones or analog sound bar .....	7
Connecting an AV receiver or digital sound bar .....	7
Preparing for Internet connectivity .....	7
AC power .....	8
Roku remote batteries .....	8
Roku TV remote .....	8
Panel buttons .....	12
Single button .....	12
Three buttons .....	13
Game-pad style joystick .....	13
Four buttons .....	13
Five buttons (with mute) .....	14
Five buttons (without mute) .....	14
Seven buttons .....	15
Guided Setup .....	16
Starting Guided Setup .....	16
Completing Guided Setup .....	17
Network connection .....	19
Activation .....	24
Connect your devices .....	25
Home screen .....	28
Personalize your Home screen .....	29
Benefits of connecting .....	31
Connecting brings out your TV's full potential! .....	31
What is streaming? .....	32
What if I didn't connect my TV? .....	33

Setting up Antenna TV .....	35
How do I set up the TV tuner?.....	36
Using your TV .....	40
Status indicator .....	40
Standby mode energy savings.....	41
Watching Antenna TV channels.....	41
Changing channels.....	41
Favorite Channels.....	42
Viewing program information.....	44
Adjusting settings while watching a show .....	45
Pausing Live TV.....	45
Requirements .....	45
Enabling Live TV Pause.....	46
Using Live TV Pause .....	46
Notes about Live TV Pause.....	48
Switching TV inputs.....	48
Auto-detecting devices.....	48
Adjusting audio/video settings.....	48
Playing content from USB storage devices.....	49
Auto player launch.....	49
Playing content from local network media servers.....	50
Setting up a payment method.....	50
Using your TV in a hotel or dorm room.....	51
About using your TV on a restricted public network .....	51
Getting your Roku TV on line on a restricted public network .....	51
Roku voice remotes (select models only).....	54
Re-pairing your Roku voice remote.....	54
Checking the Roku voice remote battery level.....	55
Adjusting TV settings .....	56
Settings menu .....	56
Options menu.....	57
Options menu settings .....	58
Picture settings.....	60
Picture settings [Config. de imagen] menu options .....	60
Sound settings.....	63
Volume modes [Modos de volumen] (select models only) .....	64
Sound settings - Dolby® Audio Processing (select models only).....	65
Sound settings - DTS® TruSurround / DTS® Studio Sound (select models only).....	66
Sound settings - Sonic Emotion Premium (select models only) .....	67
Sonic Emotion settings.....	68
Expert Picture Settings (4K models only).....	69
Changing privacy settings.....	69
Advertising.....	69

Microphone.....	70
Searching for something to watch.....	72
How do I search?.....	72
Keyboard search using the remote.....	72
Searching from the Roku mobile app.....	73
I found a show, now what? .....	73
Recent Searches.....	74
Using the Roku Channel Store .....	75
Customizing your TV .....	77
Add TV inputs.....	77
Add streaming channels.....	77
Rename inputs.....	78
Remove unwanted tiles.....	79
Rearrange tiles.....	80
Change themes .....	81
Change screensaver .....	81
Edit Antenna TV channel lineup.....	82
Change menu volume.....	83
Configure power settings .....	84
Power on settings .....	84
Auto power savings .....	84
Standby LED On/Off.....	85
Fast TV start .....	85
Changing caption settings.....	86
Customize the Home screen .....	88
Configure parental controls.....	88
Creating a parental control PIN .....	88
Blocking Broadcast TV shows.....	89
What happens when a TV show is blocked? .....	95
Changing the parental control PIN.....	96
Resetting parental controls.....	97
More settings .....	98
Guest Mode .....	98
Network settings.....	99
Time settings.....	100
Scan again for Antenna TV channels.....	101
HDMI® mode (4K models only).....	101
Control by mobile apps.....	102
Home theater configuration .....	103
Turning off the TV speakers for home theater use.....	103
Setting up a digital audio connection.....	104

Turning off the TV screen while listening to music .....	105
Controlling other devices through CEC.....	105
Restart the TV.....	108
Reset the TV .....	108
Reset audio/video settings .....	108
Factory reset everything.....	108
What if I can't access the Factory Reset option?.....	109
Network connection reset .....	110
Roku account PIN .....	110
Update the TV .....	111
Checking for updates on a connected TV.....	112
Getting updates on a non-connected TV .....	112
<b>Other devices.....</b>	<b>115</b>
Mirror your phone or tablet .....	115
Roku mobile app.....	116
Private Listening on the Roku mobile app .....	116
Universal remotes .....	117
<b>FAQ .....</b>	<b>118</b>

# Welcome

Congratulations on the purchase of your new Roku TV! Discover the joy of endless entertainment. After it's set up, you'll be able to access a world of streaming content channels that may include paid subscription channels like Netflix or free channels like YouTube, Crackle, CNET and literally thousands more.

**Important:** *Your TV receives automatic updates from time to time, enabling new content and features. This edition of the User Guide describes Roku TV version 9.2. To determine the current version of your Roku TV, go to **Settings [Configuración] > System [Sistema] > About [Acerca de]** after you complete Guided Setup.*

## The new standard in Smart TVs

Welcome to TV like you've most likely never seen before—a home screen that you can personalize with your favorite devices and streaming channels. Choose from hundreds of thousands of streaming movies and TV episodes, plus music, sports, kids, family, international and much more. You should never run out of things to watch.

**Note:** *A paid subscription or other payments may be required for some channel content. Channel availability is subject to change and varies by country.*

## Get the most out of your new TV

Follow these steps to get the most out of your new TV.

- **Connect to the Internet**
  - It's easy, and it will unlock a world of entertainment. All you need is a network connection. There are hundreds of free streaming channels, paid

subscription services, and convenient ways to rent or buy a favorite film or show with.

- **Pick your favorite streaming channels**

- Find the entertainment you love. From the latest blockbuster movies to your favorite TV shows, with tons of live sports, a broad selection of music streaming channels, popular programming in a dozen international languages, 24x7 live news and so much more, your new Roku TV has your sweet spot. A paid subscription or other payments may be required for some channels.

- **Personalize your Home screen**

- Put your favorite streaming channels, and TV inputs front-and-center on the Home screen. No more flipping through inputs or wading through complicated menus. You can even customize the names of each input and move tiles around so your most-often used devices and streaming channels are only a click away.

- **Search for your favorite movie, TV show, or actor**

- Once you're connected to the internet, you can easily search across top streaming channels and Antenna TV channels. Search by movie or TV show title, actor or director—all from one place. Search by typing words or phrases using the on-screen keyboard or on your mobile device. Some channels and content require payment.

- **Pause live TV**

- Pause, resume, fast forward, and rewind TV shows. Simply connect your own USB drive with 16GB or bigger capacity to the TV and pause live TV for up to 90 minutes.

**Note:** *Live TV Pause is available on digital TV shows received on the Antenna TV input, and only when the TV is linked to a valid Roku account.*

- **Control your TV with voice commands**

- Use your Roku Voice Remote (select models) or the free Roku mobile app to control your Roku TV. Use conversational voice commands to search for programs by title, actor, director, or genre. Also, use voice commands to launch streaming channels, or switch inputs. Additionally, use voice commands to turn the display off (for enjoying streaming music), turn

closed captions on or off, and to replay the last few seconds of a movie or TV show.

- Set sleep timers with your voice. For example, say “Turn the TV off in 30 minutes”, or “Go to sleep at 11 p.m.”
- *Only on 4K TVs*, say “Show me 4K movies” to see a list of 4K movies available across participating streaming channels.
- Use voice commands to control the Roku Media Player. If you use the Roku Media Player to play your personal music, movies, and photos, you can use voice command to find and play your stored files. Say commands like, “play classic rock on Roku Media Player,” “skip ahead 20 seconds,” or “play the next song.”
- **Send your personal media to the big screen**
  - Send personal photos, videos, and music from your compatible smartphone or tablet to the TV screen in just a few taps. Plus, with certain channels, you can send movies, shows, sport highlights, and more directly to your TV.
- **Take charge with a smartphone or tablet**
  - Control your TV with the included remote or from your compatible smartphone or tablet with the free mobile app for iOS® and Android™ mobile devices\*. Browse channels and listen to audio from Antenna TV and streaming channels.
  - Mirror your compatible smartphone or tablet on your TV. Share videos, photos, web pages, and more from compatible devices.
- **Connect your Roku TV to networks found in hotels and college dorms**
  - You can temporarily link the TV to your smartphone or tablet to agree to any terms, enter codes, or provide required information before you can get Internet access.

**Note:** *Using your Roku TV on a restricted public network requires wireless availability and use of your network-connected smartphone, tablet, or computer to authenticate access to your account. You must use your Roku TV remote to initiate the connection process. Streaming content might be*

---

\* iOS® is a trademark or registered trademark of Cisco in the U.S. and other countries and is used under license. Android™ is a trademark of Google Inc.



*limited due to your geographic location or because of restrictions imposed by the network host.*

Go to [support.roku.com](https://support.roku.com) for device compatibility information.

**Let's get started.**

# Connections and setup

Refer to your TV's Quick Start Guide or other provided documentation to for model-specific information about attaching the base or a wall mount and making connections to AC power and to your other audio/video devices. The following information applies to all Roku TV models.

## Connecting an antenna, cable, or satellite box

If you are using an antenna, CATV cable without a set-top box, or a cable or satellite box that has only an antenna output, connect a 75-ohm coaxial cable (not provided) from the device to the ANT/CABLE input on the TV.

**Tip:** *If you are using an antenna with a 300 ohm twin-lead cable, you need to use a 300-to-75 ohm adapter (not provided) to adapt the twin-lead cable to a connection that is compatible with the TV's antenna input.*

**Tip:** *If you receive your TV stations through a set top box from a cable or satellite TV provider, connect it to the TV using the best connection method available. From most to least desirable:*

- **HDMI® input** - Digital HD and SD video
- **AV input** - analog SD video
- **Antenna input** - analog SD video using NTSC

## Connecting external equipment with a composite AV video cable

If the best connection available on your device is AV or composite video output, connect it to the TV using a composite AV cable (not provided). Composite AV cables typically have three RCA-type plugs on each end, color coded as follows:

- **Yellow** - Video
- **Red** - Audio, right channel
- **White or black** - Audio, left channel

Connect each plug to the corresponding connector on the device and on the TV.

**Note:** *Select models have an AV Input that looks like a headphone jack. Use the breakout cable (included) to adapt this input to the three RCA-type plugs on your composite cable.*

## Connecting external equipment with an HDMI<sup>®</sup> cable

If possible, connect your devices using HDMI<sup>®</sup> cables (not provided). They help to provide the best video quality and also carry audio signals, so that only one cable is needed. For better picture quality, we recommend that you use cables designated as High Speed HDMI<sup>®</sup> Cables.

**Tip:** *You might need to configure the device to send its signal through its HDMI<sup>®</sup> connector.*

The connector labeled **HDMI (ARC)** or **HDMI IN (ARC)** has the additional ability to use the audio return channel to send digital audio to a receiver or sound bar, as explained in [Connecting an AV receiver or digital sound bar](#).

## Connecting headphones or analog sound bar

You can connect headphones or an analog sound bar (not provided) to the TV's headphone jack.

**Tip:** *Inserting a plug in the headphone jack disables the sound from the TV's built-in speakers.*

**Warning:** *Loud noise can damage your hearing. When using headphones, use the lowest volume setting on your headphones that still lets you hear the sound.*

Select models also have an audio line out connection that is not affected by TV volume or mute settings and does not disable the TV speakers. Use this connection when you want to use your amplifier or sound bar to control the TV volume. To turn off the TV's built-in speakers, in the Home screen menu, navigate to **Settings [Configuración] > Audio [Audio] > TV speakers [Altavoces de TV]** and change the setting.

## Connecting an AV receiver or digital sound bar

You can enjoy Dolby Audio™ multichannel sound from your TV if you connect a digital amplifier or sound bar (not provided) in either of two ways:

- **Digital optical audio out (S/PDIF)** – Connect a TOSLINK optical cable (not provided) from the TV to the Optical input on your receiver or sound bar.
- **HDMI® ARC** – Connect an HDMI® cable (not provided) from the **HDMI (ARC)** connector to the HDMI® input on your receiver or sound bar. This connection uses the Audio Return Channel (ARC) feature of the HDMI® specification to output sound from the TV to a compatible device. To use this feature, you must configure the TV to enable HDMI® ARC, as explained in [Enable HDMI® ARC](#).

## Preparing for Internet connectivity

If you want to watch streaming content and take advantage of the cool features of your Roku TV, connect it to the Internet through a wireless modem/router or a wireless access point (not provided). The TV has a built-in wireless LAN adapter.

**Note:** *The TV supports only its internal wireless network adapter—it does not support the use of a USB network adapter.*

Select 4K models have wired in addition to wireless network connectivity. To use the wired network connection, connect an RJ-45 Ethernet cable (not provided) from the jack on the back of your TV to your network router or switch. The wired connection supports both 10 Base-T and 100 Base-T Ethernet.

## AC power

Plug your TV into a power outlet. You can tell that the TV has power because the status indicator lights up when the TV is off.

The topic [Status indicator](#) explains how the status indicator shows what is happening with the TV.

## Roku remote batteries

Open the back of your Roku remote and insert the included batteries, observing the proper orientation as indicated in the battery compartment. Reattach the back cover.

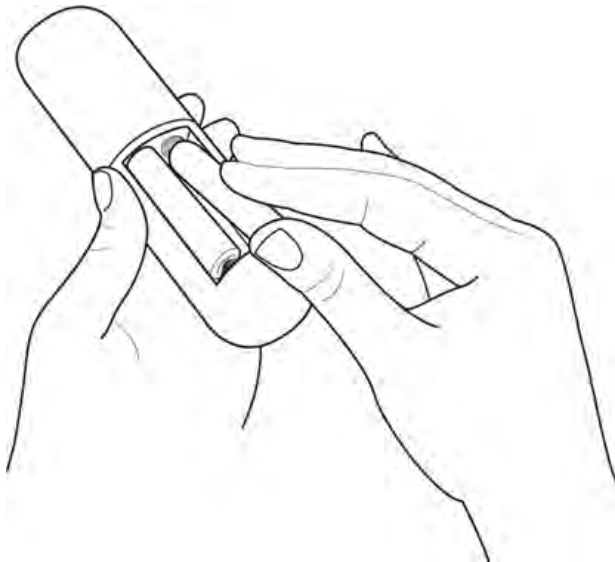









## Roku TV remote

Use the following information to identify the buttons on your Roku remote.





**Note:** Certain remote buttons and features vary by model. Your remote might not have all buttons or features listed.

If your remote has a microphone button  just below the purple pad, then you have a Roku Voice Remote.

BUTTON	FUNCTION	DESCRIPTION
	POWER	Turns TV on and off.
	BACK	<ul style="list-style-type: none"> <li>• Menu: Goes back to previous menu/screen.</li> <li>• Home screen tile: Moves highlight back to the Home screen option.</li> <li>• Watching Antenna TV or a TV input: Returns to Home screen.</li> <li>• Playing streaming content: Stops playing stream and returns to the previous menu or screen.</li> <li>• Browsing streaming content: Goes to the previous level in the content tree.</li> </ul>
	HOME	Immediately returns to the Home screen.
	PAD	<ul style="list-style-type: none"> <li>• <b>LEFT/RIGHT/UP/DOWN</b> moves the highlight in the corresponding direction.</li> <li>• <b>OK</b> selects the highlighted option.</li> </ul> <p>While watching TV:</p> <ul style="list-style-type: none"> <li>• <b>UP/DOWN</b> changes channel.</li> <li>• <b>LEFT</b> displays the channel list.</li> <li>• <b>LEFT/RIGHT</b> while in the channel list, switches between All Channels and Favorite Channels.</li> <li>• <b>OK</b> while in the channel list selects the highlighted channel.</li> </ul> <p>While watching live TV: displays the program information banner.</p>

BUTTON	FUNCTION	DESCRIPTION
	<b>VOICE SEARCH</b> and <b>VOICE</b> <b>COMMANDS</b>	<p><i>Only on select models with Roku voice remotes, hold and say</i></p> <ul style="list-style-type: none"> <li>• The name of a movie, TV show, actor, director, or game name.</li> <li>• Search for special genres “free” and “4K”.</li> <li>• Use your voice to start streaming, change a channel, and more.</li> </ul> <p>For more information, go to: <a href="https://go.roku.com/voicesearch">go.roku.com/voicesearch</a></p>
	<b>GAME MODE</b>	<p><i>Select models.</i> Displays a banner showing the current Game mode or <b>Not available at this time [No está disponible en este momento]</b> . Subsequent presses toggle Game mode. When <b>On [Activado]</b>, the TV performs less image processing and has less input lag, producing a better experience with action games. <i>Available only for HDMI and AV inputs.</i></p> <p><i>Select models.</i> Auto Low Latency Mode (ALLM) detects certain game consoles connected to an HDMI input and automatically switches to the best settings for action games. When ALLM is active, the manual <b>Game mode [Modo de juego]</b> setting is unavailable.</p>
	<b>REPLAY</b>	<p><i>Select models.</i> Streaming programs that support this feature and Antenna TV channels: if Live TV Pause is enabled, jumps back a few seconds with each press and resumes playing.</p> <p>Broadcast TV: If Live TV Pause is disabled, jumps to previous channel.</p> <p>When using an on-screen keyboard: Backspaces in the text you are entering.</p>
	<b>SLEEP</b>	<p><i>Select models.</i> Displays a banner showing the remaining sleep time, if any, or <b>Sleep timer is off [El apagado programado está desactivado]</b>. Subsequent presses cycle among the preset sleep time intervals. Once set, the sleep timer remains in effect regardless of what you are watching.</p>

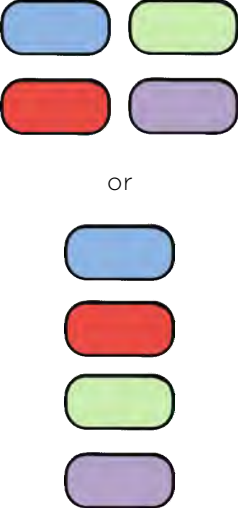

BUTTON	FUNCTION	DESCRIPTION
	<b>MEDIA PLAYBACK CONTROLS</b>	<p>Rewind, pause, play, and fast forward streaming content and Antenna TV channels (if Live TV Pause is enabled).</p> <p>Press <b>REWIND</b> ◀◀ or <b>FAST FORWARD</b> ▶▶ one, two, or three times to control the speed of the operation.</p> <p><b>REWIND</b> ◀◀ and <b>FAST FORWARD</b> ▶▶ also jump backward and forward one screen at a time when viewing long lists, such as when you are browsing Antenna TV shows in the channel list.</p>
	<b>OPTIONS</b>	<p>Displays additional options when available. On-screen hints let you know when this button is active.</p>
 <p style="text-align: center;">or</p>	<b>FACTORY ASSIGNED CHANNEL SHORTCUT</b>	<p>Dedicated buttons show the logo of a preset streaming content provider. Dedicated content providers vary by model and region. Pressing a button:</p> <ul style="list-style-type: none"> <li>• Displays the streaming channel's main page if you have already added the channel to your Home screen.</li> <li>• Displays the streaming channel's sign-up page if you have not already added the channel.</li> </ul>
	<b>VOLUME/MUTE</b>	<p>Located on the right edge of the remote. Increases/decreases volume and mutes the TV sound.</p> <p><b>Note:</b> <i>If the TV is muted, pressing <b>VOLUME UP</b> unmutes. Pressing <b>VOLUME DOWN</b> does not unmute the sound.</i></p>

# Panel buttons

Your TV has a set of panel buttons that perform simple control functions. The TV panel buttons are not a substitute for the remote, as they do not give you access to all TV functions.

Depending on model, your TV model has one of several different panel button designs. Choose the one that applies to your TV from the following list:

- [Single button](#)
- [Three buttons](#)
- [Game-pad style joystick](#)
- [Four buttons](#)
- [Five buttons \(with mute\)](#)
- [Five buttons \(without mute\)](#)
- [Seven buttons](#)

## Single button

If your TV has this style of panel button, you can perform the following functions:

- **Turn TV on:** short press.
- **Display the Input List:** short press when TV is on.
- **Select the next input in the Input List:** short press while the TV is showing the Input List.
- **Dismiss the Input List without changing inputs:** no press.
- **Turn TV off:** long press.

Short press = less than two seconds

Long press = more than two seconds

No press: = no press within two seconds

## Three buttons

If your TV has this style of panel buttons, you can perform the following functions:

- **Turn TV on:** middle button, short or long press.
- **Volume up:** right button when Input List is not active.
- **Volume down:** left button when Input List is not active.
- **Display Input List:** middle button, short press when TV is on.
- **Highlight next input in the Input List:** right button when Input List is active.
- **Highlight previous input in the Input List:** left button when Input List is active.
- **Select highlighted item in the Input List:** middle button, short press, or no press.
- **Turn TV off:** middle button, long press.

Short press = less than two seconds

Long press = more than two seconds

No press: = no press within four seconds

## Game-pad style joystick

If your TV has this style of panel button, you can perform the following functions:



- **Press in:** Toggle between power ON and Standby.
- **Press up or down:** Increase/decrease the volume.
- **Press left or right:** Switch inputs. Each press moves the highlight up or down one item. Pausing for a few moments selects the highlighted item.

## Four buttons

If your TV has this style of panel buttons, you can perform the following functions:

- **Power:** Turns the power on and off.
- **Input:** Selects among TV inputs. Each press moves down one item. Pausing for a few moments selects the highlighted item.
- **Volume +:** Increases the volume.
- **Volume -:** Decreases the volume.

## Five buttons (with mute)

If your TV has this style of panel buttons, you can perform the following functions. Note that the order of the buttons might vary from model to model. Examine the panel button labels to determine your TV model's layout.

- **Power:** Turns the power on and off.
- **Input:** Selects among TV inputs. Each press moves down one item. Pausing for a few moments selects the highlighted item.
- **Volume +:** Increases the volume.
- **Volume -:** Decreases the volume.
- **Mute:** Mutes and unmutes the sound.

## Five buttons (without mute)

If your TV has this style of panel buttons, you can perform the following functions. Note that the order of the buttons might vary from model to model. Examine the panel button labels to determine your TV model's layout.

- **Power:** Turns the power on and off.
- **Input +:** Selects the next TV input. Each press moves down one item. Pausing for a few moments selects the highlighted item.
- **Input -:** Selects the previous TV input. Each press moves up one item. Pausing for a few moments selects the highlighted item.
- **Volume +:** Increases the volume.
- **Volume -:** Decreases the volume.

## Seven buttons

If your TV has this style of panel buttons, you can perform the following functions. Note that the order of the buttons might vary from model to model. Examine the panel button labels to determine your TV model's layout.

- **Input:** Selects among TV inputs. Each press moves down one item. Pressing **Channel +** or **Channel -** moves the highlight up or down. Pausing for a few moments selects the highlighted item.
- **Channel +:** Moves the highlighted item up in the current menu.
- **Channel -:** Moves the highlighted item down in the current menu.
- **Volume +:** Increases the volume.
- **Volume -:** Decreases the volume.
- **Mute:** Mutes and unmutes the sound.
- **Power:** Turns the power on and off.

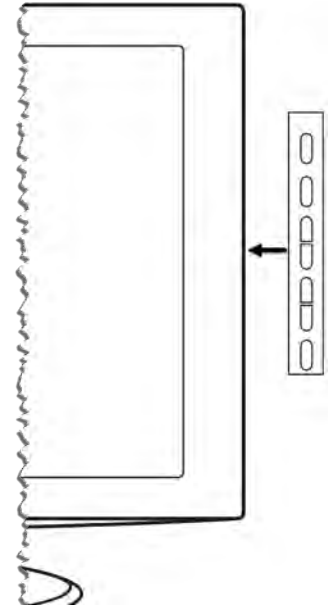

# Guided Setup

With the preliminaries out of the way, it's time to turn on your TV. As the TV starts for the first time, it leads you through Guided Setup, which configures the TV before you start to use it.

During Guided Setup, you'll:

- Answer a few questions
- Provide network connection information
- Get a software update
- Link your TV to your Roku account.
- Connect devices such as a DVD player, game console, or cable box.

## Starting Guided Setup

To start Guided Setup, press the **POWER** button on the remote to turn on your TV.

**Note:** *Guided Setup normally runs only once, the first time you turn on your TV. If you need to run Guided Setup again, you'll have to perform a factory reset, as explained in [Factory reset everything](#).*

When you first turn on your TV, it will take a few seconds to get itself ready. You'll notice the following things happening:

1. The status indicator blinks every time the TV is busy doing something; in this case it's powering up and getting ready for you.
2. The power-on screen appears and the status indicator blinks slowly for a few more seconds. The power-on screen shows a brand logo while the TV starts up.
3. After a few seconds, Guided Setup starts.

## Completing Guided Setup

Follow these steps to complete Guided Setup. At this point, you should be seeing the **Language [Idioma]** screen.



1. *Only on models that have a Roku voice remote:* A few moments after the **Let's get started screen** appears, Guided Setup starts the pairing process for the voice remote. (You'll know if you have this type of remote because it will have microphone or search button just below the down arrow on the purple pad.) If the voice remote does not pair automatically, follow the instructions on the screen to complete the pairing process.
2. Press the **DOWN** arrow on the remote to highlight your preferred language, and then press **OK** or the **RIGHT** arrow.



3. *Some models have a country selection screen:* If you don't see this screen, skip ahead to the next step. If you see this screen, select your country.



**Note:** *If you enabled the Audio Guide, choosing any country other than United States disables it.*

4. Press **OK** or the **RIGHT** arrow on the remote to go to the next screen:



5. Press **OK** to select **Set up for home use [Configurar para uso en el hogar]**. This is the right choice for enjoying your TV at home. It provides energy saving options as well as access to all features of the TV.

**Note:** *Store mode configures the TV for retail display and is not recommended for any other use. In store mode, some features of the TV are missing or limited. To switch from one mode to the other, you have to perform a factory reset as explained in [Factory reset everything](#), and then repeat Guided Setup.*

## Network connection

After you select **Set up for home use [Configurar para uso en el hogar]**, the TV prompts you to make a network connection. If your TV has both wired and wireless connections, you'll see the following screen.

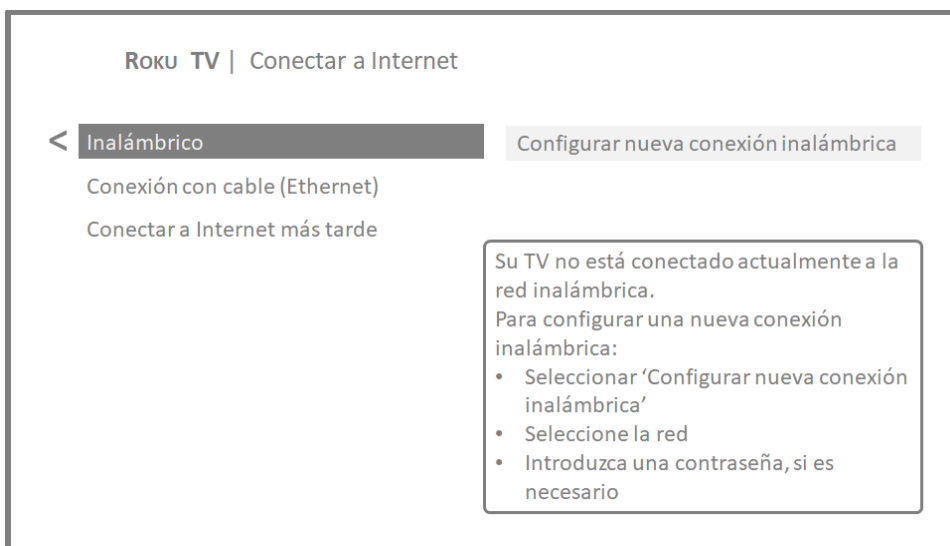

6. *Only models that display the **Connect to the Internet [Conectar a Internet]** screen:* Make a selection:

- **Wireless connection [Conexión inalámbrica]** – Highlight **Set up new wireless connection [Configurar nueva conexión inalámbrica]** and press **OK**. The TV prompts you through wireless setup. Skip ahead to the next step for help with the process.
- **Wired connection [Conexión por cable]** – Highlight **Connect to wired network [Conectar a la red con cables]** and press **OK**. The TV immediately

attempts to connect to your wired network, your local network, and then the Internet. Go to Step 9 to continue with Guided Setup.

- **Connect to the Internet later [Conectar a Internet más tarde]** – If you don't want to connect to the Internet right now, you can skip this step and use the TV to watch Antenna TV channels, and to play games and watch DVDs through the devices you connect to it. When you're ready to connect, it's easy. We'll show you how in [Benefits of connecting](#).

**Note:** *If you decide not to connect, Guided Setup skips ahead to setting up the devices that you've connected to your TV. Jump ahead to [Connect your devices](#) to complete Guided Setup.*

7. *On models that have wireless only, or models with both wired and wireless and you've selected **Wireless [Inalámbrico]**: The TV scans for the wireless networks within range and displays them in order, with the strongest signals first. In addition to your own wireless signal, the TV might pick up signals from your neighbors.*



Press the **UP** or **DOWN** arrows to highlight the name of your wireless network, and then press **OK** to select it.

**Note:** *Some networks, such as those often found in dorm rooms, hotels, and other public places, require you to read and agree to terms, enter a code, or provide identifying information before letting you connect to the Internet. If your Roku TV detects that you are connecting to such a network, it prompts*

you through the connection process using your compatible smartphone or tablet to provide the needed information. For more information, see [Using your TV in a hotel or dorm room](#).

## Other options

- **Connect to the Internet later [Conectar a Internet más tarde]** – If you don't want to connect to the Internet right now, you can skip this step and use the TV to watch Antenna TV channels, and to play games and watch DVDs through the devices you connect to it. When you're ready to connect, it's easy. We'll show you how in [Benefits of connecting](#).

**Note:** *If you decide not to connect, Guided Setup skips ahead to setting up the devices that you've connected to your TV. Jump ahead to [Connect your devices](#) to continue.*

- **Scan again / Scan again to see all networks [Volver a escanear / Escanear para ver todas las redes]** – The name of this option depends on the number of wireless networks within range.
  - **Scan again [Volver a escanear]** appears if the list already shows all available wireless networks within range. If you don't see your wireless network name in the list, you might need to adjust the location of your wireless router or the TV, turn on your router, or make other changes. When everything is ready, select **Scan again [Volver a escanear]** to see if your network name now appears in the list.
  - **Scan again to see all networks [Escanear para ver todas las redes]** appears if there are more wireless networks than the strongest ones it initially listed. If you don't see your wireless network name in the list, this option displays the complete list. If you still don't see your network name, you might have your router configured to provide wireless service as a "private network."

**Note:** *Highlighting either of these options displays an informational panel with the unique media access control (MAC) address of your Roku TV. You will need the MAC address if your wireless router is configured to use MAC address filtering.*

- **Private network [Red privada]** – If your wireless network name is hidden, it won't appear in the list. Select **Private network [Red privada]** to display an on-screen keyboard, and use it to enter your network name. Unless you changed the factory-set network name, you can find the name (also called SSID) on a label on the router.

**Tip:** *Wireless networks that are password-protected display a “padlock” icon adjacent to the name. This icon enables you to know that you are going to be prompted to enter a password after you select that network.*



8. *Only if you select a password protected wireless network. An on-screen keyboard appears. Use the keyboard to enter the network password.*

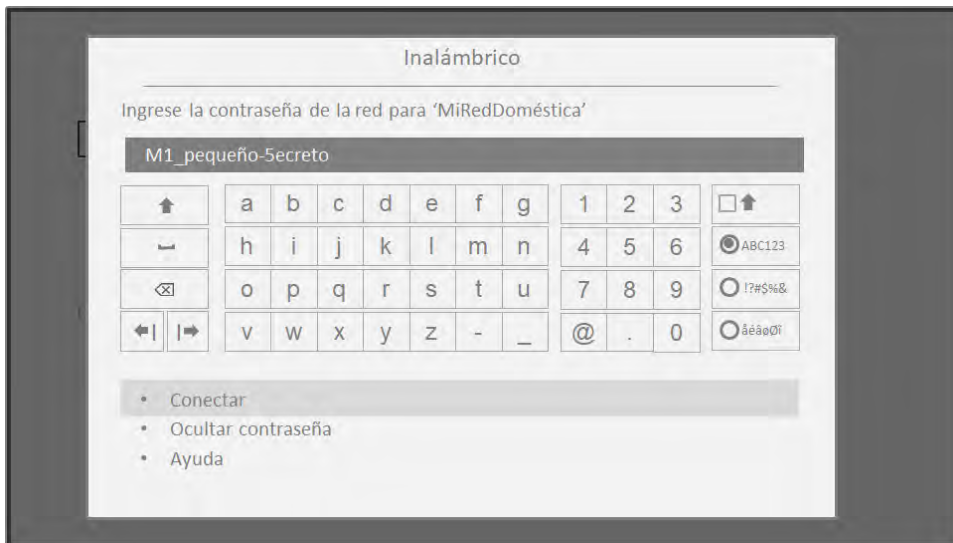

After you submit your wireless network password, the TV displays progress messages as it connects to your wireless network, your local network, and the Internet.

9. Only if your TV cannot get the correct time zone and current time from your network service provider. Use the **UP** and **DOWN** arrows to highlight your time zone, and then press **OK**.

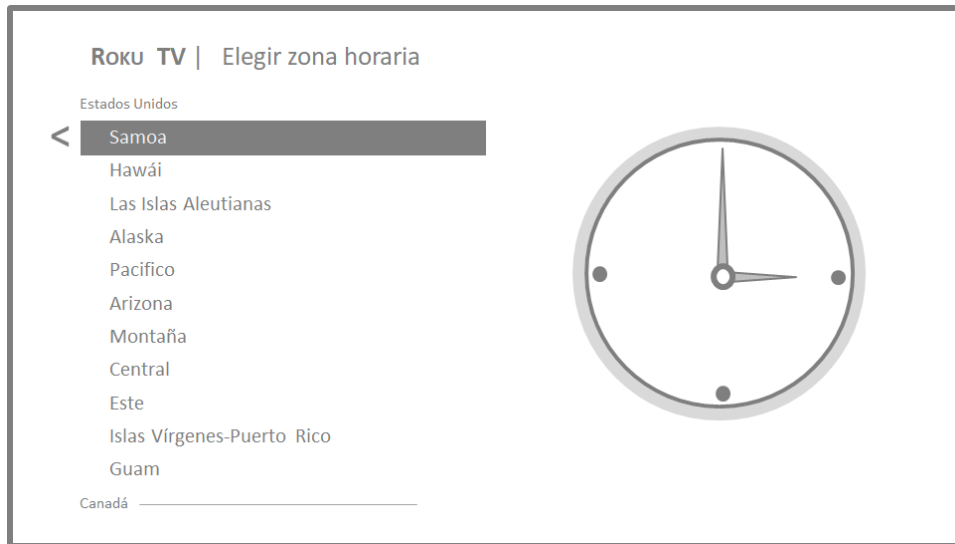

**Tip:** Your TV needs to know the local time zone so that it can correctly display information about the program you are currently watching.

As soon as the TV is able to connect to the Internet, it downloads and installs its first software update, and then restarts.

**Tip:** Your TV automatically checks for updates periodically. These updates provide new features and improve your overall experience with the TV. After an update, you might notice that some Options have moved, and that there are new options or features. This User Guide describes version 8.2. To determine your current Roku TV software version, go to **Settings [Configuración] > System [Sistema] > About [Acerca de]** after you complete Guided Setup. You can download an updated User Guide that matches your Roku TV software version from the Roku TV web site.

## Activation

After the TV restarts, it displays the [Activar su TV screen:



10. Using a compatible computer, tablet, or smartphone with an Internet connection, go to the web address displayed on the screen and enter the code that appears on your screen.

---

### Why do I need a Roku account?

You need a Roku account for several reasons:

- It links you, your Roku TV, and your other Roku streaming devices to the Roku Channel Store and billing service.
- Streaming content providers know that it's OK to send content you request to your Roku TV.
- Roku can automatically send updates to your device.

You need a Roku account to activate your device and access entertainment across thousands of streaming channels. Linking to a Roku account also activates several advanced features on your TV, such as Guest Mode, the Roku Mobile App, and Live TV Pause, to name a few. Roku accounts are free, and while a valid credit card number is not required to create your account, providing your credit card information makes renting and purchasing entertainment from the Roku Channel Store fast and convenient.

After you log in or create your Roku account, the link page suggests that you select some streaming channels. After you confirm your selections, the TV gets an acknowledgement, and then adds your preexisting and newly-selected streaming channels to your Roku TV. This process is automatic and takes a few moments—a little longer if you already have a lot of streaming channels to add.

**Tip:** *Streaming channels from all Roku streaming devices associated with your account are synchronized periodically, so that all of your Roku streaming devices have the same set of streaming channels (subject to compatibility with the device).*

## Connect your devices

Next, Guided Setup helps you set up the external devices that you want to use with it, such as a cable box, Blu-ray™ player, or game console.

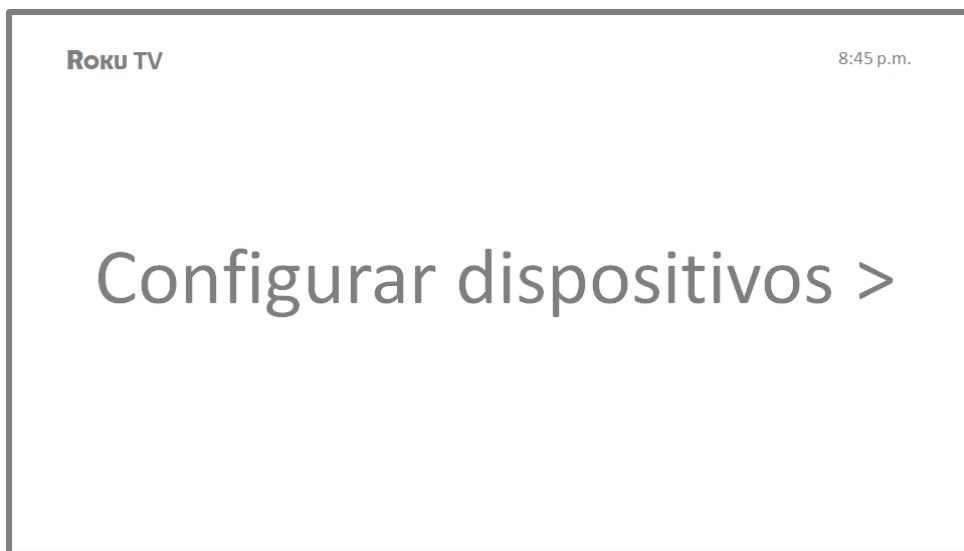



11. Press **OK** or the **RIGHT** arrow to proceed:

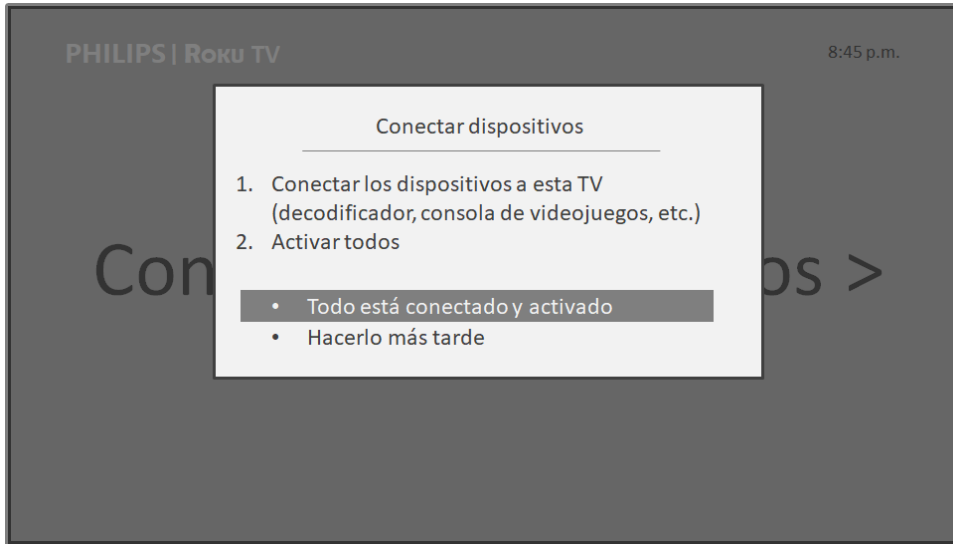

12. Connect all the devices you plan to use with your TV, turn them all on, and then select **Everything is plugged in and turned on [Todo está conectado y activado]**. The TV now takes you step by step through each of its inputs and asks what kind of device you have connected. On each input that has a connected and active device, you can see its picture and hear its sound.



13. Press the **UP** or **DOWN** arrows to highlight the label you want to associate with the input. If you are not using the input, select **Nothing [Nada]**, and the input won't appear on the Home screen.

14. While setting up your devices, rather than using the predefined names and icons, you can set a custom name and icon. To do so, scroll up or down to highlight **Set custom name & icon [Nombre personalizado... (abbrev. to fit U)]**, and then press **OK**. Follow the instructions on the screen to enter a name and select an icon for the input. See [Rename inputs](#) for more information.
15. Repeat the previous step for each input.

You're done with Guided Setup.

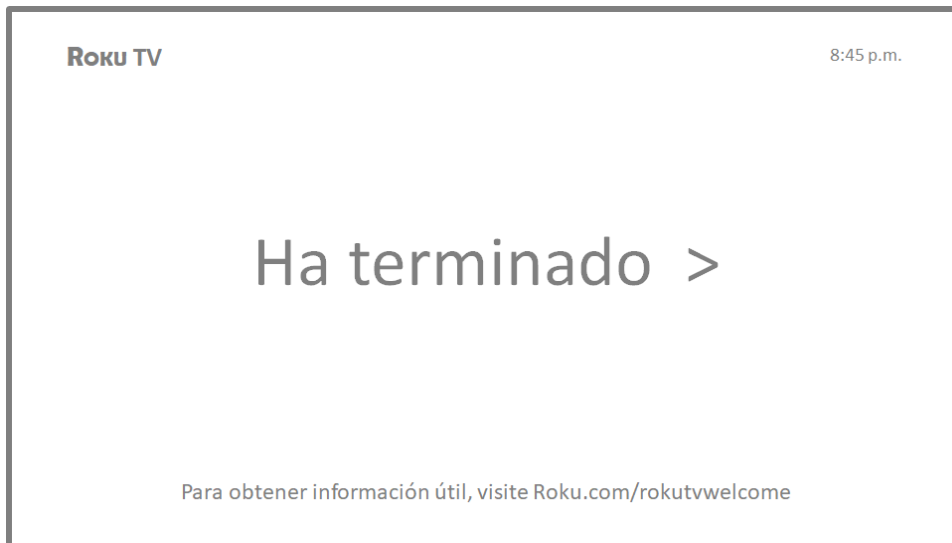

**Note:** *Some Roku TVs, depending on where you live and other factors, show you an introductory video filled with some great hints and tips. If you're not interested in viewing this video, press  on the remote to return to the Roku TV Home screen.*

Whenever you press  on the remote, the Home screen greets you.

From here, you can explore everything your TV has to offer. Press the arrow keys to move around, and press **OK** to select a highlighted item. We've designed the TV to encourage you to explore, and you can probably figure out most of the capabilities and settings on your own. If you have any questions or difficulties, you can find answers and solutions in this guide.

# Home screen

The following illustrations show typical Home screens, which vary depending on location, connected mode, selected theme, number of TV inputs enabled, and streaming channels and apps added.

**Note:** *A paid subscription or other payments may be required for some channel content. Channel availability is subject to change and varies by country. Not all content is available in countries or regions where Roku® products are sold.*

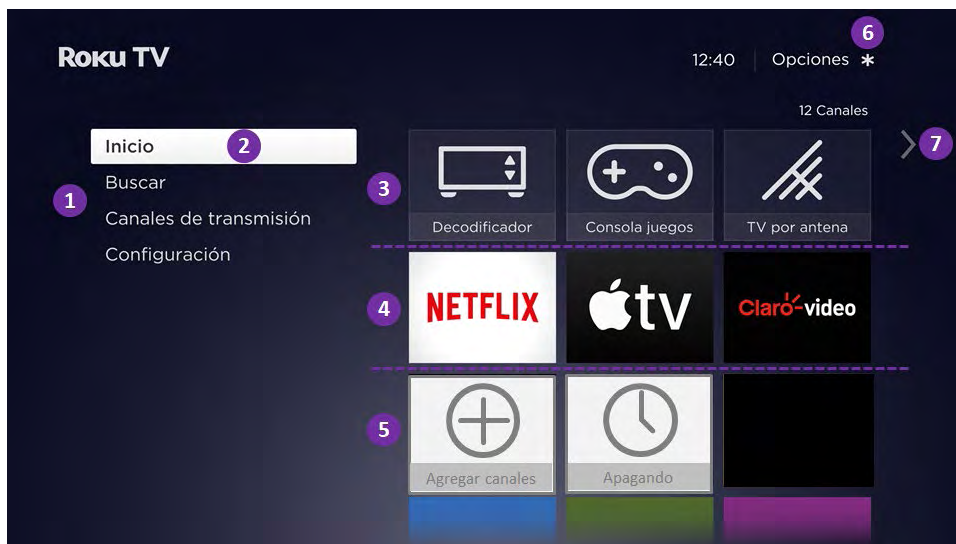

Typical connected Home screen, Mexico

1. Home screen menu—shows options available to you when you are on the Home screen.
2. Highlighted option—press **OK** on the remote to select.
3. TV input tiles—select an input to watch the connected device.
4. Streaming channel and app tiles—select a tile to go to the indicated streaming channel or application.
5. Direct access tiles - shortcuts to often used features.
6. Options hint—press **\*** on the remote for options when this symbol is present.
7. Next screen hint—press the **RIGHT** arrow on the remote to see the next screen.

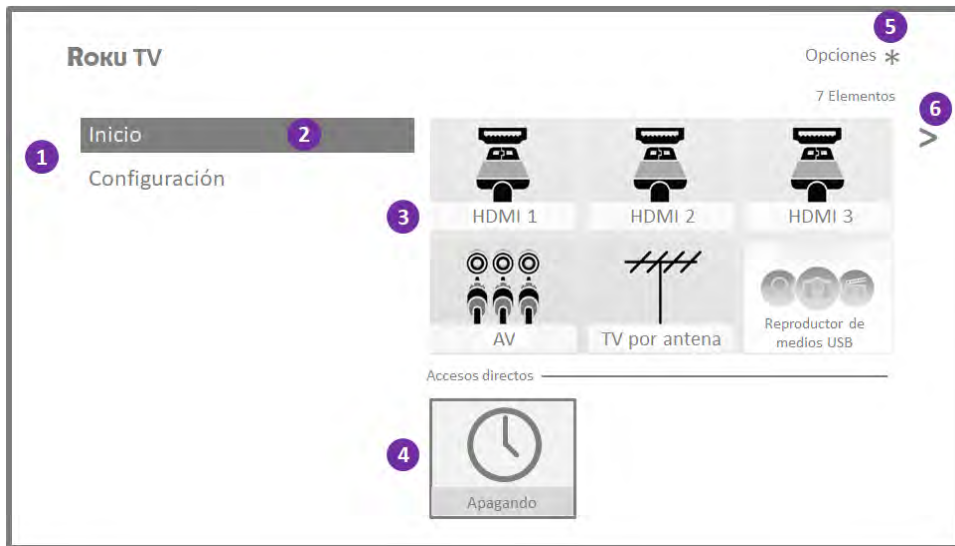

Typical non-connected Home screen

1. Home screen menu—shows options available to you when you are on the Home screen.
2. Highlighted option—press **OK** on the remote to select.
3. TV input tiles—select an input to watch the connected device.
4. Direct access tiles - shortcuts to often used features.
5. Options hint—press **\*** on the remote for options when this symbol is present.
6. Next screen hint—press the **RIGHT** arrow on the remote to see the next screen.

## Personalize your Home screen

There are many things you can do to personalize your Home screen and make it just right for you and your family:

- *Only in connected mode:* Add streaming channels by using the **Streaming Channels [Canales de transmission]** menu option to browse the Roku Channel Store.
- *Only in connected mode:* Change the screen theme by going to **Settings [Configuración] > Themes [Temas]** to find and pick one to suit your mood.
- [Customize the Home screen](#). Hide or show the newly-introduced shortcut tiles that appear at the bottom of your Home screen grid.
- Remove a tile by highlighting it and pressing **\***. Then highlight **Remove input [Eliminar entrada]** or **Remove channel [Eliminar canal]** and press **OK**.

- Move a tile by highlighting it and pressing **\***. Then highlight **Move input [Mover entrada]** or **Move channel [Mover canal]** and press **OK**. Use the arrows to move the tile, and then press **OK** to lock it in its new location. Move the shortcut tiles within the shortcut area only. Shortcuts are designed to always appear at the very bottom of the grid, so you can access them quickly by pressing **UP** once when you're at the top of the grid.
- Rename a TV input tile by highlighting it and pressing **\***. Then highlight **Rename input [Renombrar entrada]** and press **OK**. Highlight a new name in the list, and then press **OK** to assign that name to the tile.

Rather than using the predefined names and icons, you can set a custom name and icon. To do so, scroll up or down to highlight **Set custom name & icon [Nombre personalizado... (abbrev. to fit UI)]**, and then press **OK**. Follow the instructions on the screen to enter a name and select an icon for the input.

# Benefits of connecting

## Connecting brings out your TV's full potential!

### Make any night a movie night

Thousands of movies to choose from, across all major streaming movie channels\*. You'll never run out of something new to watch.

### Get in the groove

Stream endless hours of music from free and subscription-based channels. With almost instant access to thousands of music artists, your favorite beats are just as close as your remote.

### Explore your passions

In addition to popular streaming channels, your Roku TV also offers hundreds of streaming channels to fuel your passions—including fitness, cooking, religion, outdoors, International programming and much more.

### Enjoy FREE trials of popular channels

Your Roku TV comes loaded with special offers, including free trials (if eligible) from popular streaming channels. REMEMBER THAT YOU MUST CANCEL BEFORE THE FREE TRIAL ENDS TO AVOID SUBSCRIPTION FEES.

### Take advantage of awesome features

**Powerful, voice-enabled search** helps you use Spanish language voice commands to find movies and TV shows by title, actor, director name across multiple streaming channels.

---

\* A paid subscription or other payments may be required for some channels. Channel availability is subject to change and varies by country. Not all content is available in countries or regions where Roku® products are sold.

**Automatic account linking** keeps track of supported streaming subscriptions on other Roku devices, so that you won't have to re-enter your user name and password when adding the same channel on your newly-activated Roku TV.\*

**Live TV Pause** lets you connect a USB drive (not provided) and pause live TV for up to 90 minutes. After pausing, you can play, fast-forward, rewind, and pause again to any point within the rolling 90 minute window.

**Mobile Private Listening** on the Roku mobile app lets you listen to streaming programs and “over-the-air” TV shows from the Antenna TV input on headphones (not provided) plugged into your IOS® or Android™ mobile device.

## What is streaming?

Streaming is viewing or listening to video or audio content that is sent over the Internet, or located on a network-connected media server or on a USB device plugged into the TV's USB port.

With streaming, you can buy or rent most programs on demand, when it's convenient for you. When streaming, you can play, pause, rewind, and fast forward most of what you are watching. You can also replay the last few seconds again, or turn on closed captions, if available.

**Tip:** *Some content cannot be paused or skipped. For example, if you are viewing live programming or a program that is supported by ads, you might not be allowed to skip the ads.*

Your Roku TV lets you choose from thousands of streaming channels that offer a huge selection of entertainment:

- Thousands of movies and TV episodes
- Unlimited music, live and on-demand
- Tons of live and on-demand sports
- Programming for kids and family
- International programming in 22 languages
- 24x7 news and in-depth news commentary

---

\* Not all streaming channels currently support automatic account linking.

Many streaming channels are free. Some streaming channels let you purchase or rent the latest movie releases or popular TV series. Some channels charge a monthly subscription fee and others are available at no additional cost if you subscribe to a companion service through your cable or satellite provider.

If you have an existing subscription to a service like Netflix, you can just sign in with your existing user name and password.

To play streaming content, you add streaming channels to your Home screen. Use the **Streaming Channels [Canales de transmisión]** option on the Home screen menu to go to the Channel Store, and then select the streaming channel you want to add. The channel remains on your Home screen unless you remove it, and you can watch it at any time.

For more information on using the Roku Channel Store feature, see [Using the Roku Channel Store](#).

**Note:** *A paid subscription or other payments may be required for some channels. Channel availability is subject to change and varies by country. Not all content is available in countries or regions where Roku® products are sold.*

## What if I didn't connect my TV?

What if you went through Guided Setup and chose **Connect to the Internet later [Conectar a Internet más tarde]**? No worries. Your Roku TV makes it easy to connect whenever you want. As you move around the Home screen, you'll see several places where you can start the connection process. For example:

- Now and then you'll see a message appear on the panel to the right of the Home screen offering a **Connect Now Conéctese ahora** option. Simply highlight and select the **Connect Now [Conéctese ahora]** option to get started.
- Use the **Connect and activate now [Conéctese y actívelo ahora]** option in the **Settings [Configuración]** menu. From the Home screen menu, select **Settings [Configuración]**, then **Network [Red]**, and then **Connect and activate now [Conéctese y actívelo ahora]**.
- If you want to start over from the beginning, use the **Settings [Configuración]** menu to do a **Factory reset [Restablecimiento de fábrica]**, and then go



through Guided Setup again. This time, choose your home network when prompted.

# Setting up Antenna TV

In addition to the other entertainment possibilities of your Roku TV, you may also want to watch broadcast channels from an antenna or cable TV service connected to the ANT input. On your Roku TV, you watch broadcast TV in much the same way you watch other entertainment choices. You select a tile—in this case, the **Antenna TV [TV por antenna]** tile—from the Home screen.

The first time you select the **Antenna TV [TV por antenna]** tile, you have to set up the TV tuner. Setting up the TV tuner scans for active channels and adds them to your Antenna TV channel list.

---

## Why do I have to set up the TV tuner?

Not everyone needs to use the TV tuner. For example, you might have a set top box provided by a cable or satellite company that receives all of your channels. Most of these set top boxes use an HDMI® connection.

More and more people are watching only streaming TV and do not have a TV antenna or cable/satellite service. If you don't need the TV tuner, you can bypass setting it up and instead remove it from the Home screen as explained in [Remove unwanted tiles](#).

When you set up Antenna TV, the TV scans the signals on its antenna input for channels with a good signal, and adds those to the channel list, skipping dead channels and channels with a very weak signal.

The TV lets you add two analog channels, even if they have no signal, for the purpose of using an older set top box, VCR, or game console that can only output a signal on analog channel 3 or 4. Typically, you'll only need one of these channels, but both are provided to make setup simpler. You can hide the one you don't want as explained in [Edit Antenna TV channel lineup](#).

---

## How do I set up the TV tuner?

1. Make sure your antenna (not provided) or TV cable is connected to the TV's **ANT/CABLE** input.
2. On the Home screen, select the **Antenna TV [TV por antenna]** tile.
3. Read the simple on-screen instructions, and then select **Start finding channels [Comenzar a buscar canales]**.



4. If prompted, select your time zone. You'll only need to do this if the TV can't figure out your time zone from your Internet connection.

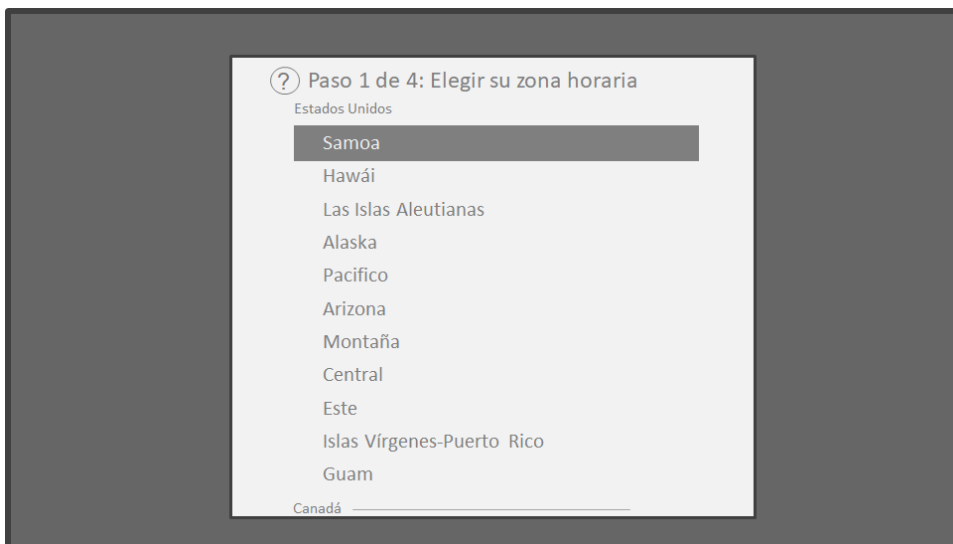

---

## Why does the TV need my time zone?

The TV needs to know your time zone so that it can correctly display time information about the program you are currently watching.

---

- When prompted, select whether to add analog channels 3 and 4. These channels enable you to connect older set top boxes, VCRs, or game consoles.

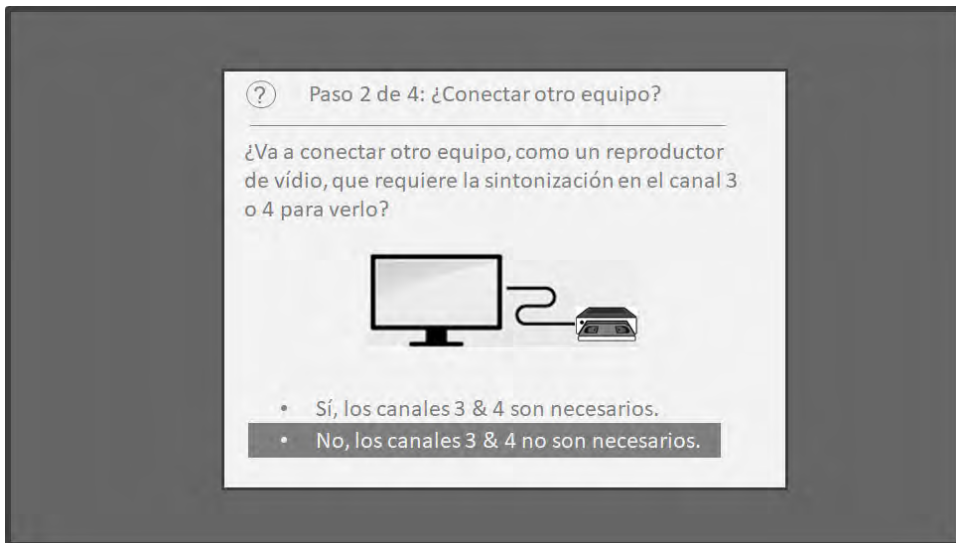

- Wait while your TV scans for Antenna TV stations...



... and then cable TV channels.



Scanning for channels can take several minutes.

**Tip:** *If you use a set-top box to receive cable TV channels (and don't have your cable connected directly to the TV's **ANT** input), you can save time by skipping the cable TV portion of the channel scan.*

7. When the channel scans finish, the TV shows the number of channels it added.





8. *Only in connected mode*, you have the option of setting up Live TV Pause. The topic [Pausing Live TV](#) explains how to set up and use this feature. If you don't

want to set up Live TV Pause, or if this option is not available to you, select **Done** to start watching Live TV.

**Tip:** Repeat the channel scan from time to time to make sure you are receiving all of the latest channels. Broadcasters add and remove channels, move channels to different parts of the spectrum, and change the power levels of their channels periodically. Your antenna reception and picture quality depend on the position of your antenna and on your location relative to the antennas of broadcasters in your area.

**Note:** You'll have to repeat the channel scan if you remove and re-add the **Antenna TV [TV por antenna]** tile from the Home screen or perform a factory reset. To repeat the channel scan, go to **Settings [Configuración] > TV inputs [Entradas de TV] > Antenna TV [TV por antenna] > Scan for channels [Escanear canales] > Start finding channels [Comenzar a buscar canales]**.

Now, you're ready to watch Antenna TV! While you're watching, try the following tips:

- Press the **UP** and **DOWN** arrows to change channels.
- Press the **LEFT** arrow to display the channel list, and then use the **UP** and **DOWN** arrows to select a channel to watch. Or press **REWIND** ◀ or **FAST FORWARD** ▶ to jump through the channel list a page at a time.
- Press **OK** to display information about the current program.
- Press **\*** to see options for picture and sound settings.
- *Only on models that have a Roku voice remote, using Spanish language, hold down  or , and then say the name of a movie, TV show, actor, director, or the name of a genre like "comedies or "musicals." The TV displays the result and the streaming channels that offer the requested content.*

**Note:** If you do not have a Roku voice remote, you can use the Roku mobile app to search. For more information, see [Roku mobile app](#).

# Using your TV

This section provides information on using the day-to-day features of your TV.

## Status indicator

Your TV has a single status indicator. It goes on and off and blinks in different ways depending on the status of the TV, as shown in the following table:

TV CONDITION	STATUS INDICATOR	MEANING
On (screen is active)	Off	Screen is communicating that TV is on.
Screensaver (screen is active)	Off	Screen is communicating that TV is on.
Off (no power)	Off	TV is not connected to power.
Off (standby)	On	TV is connected to power and is ready to use.
Starting up from off state	Slow pulsing blink until startup completes	TV is doing something.
On (receiving update from USB)	Slow pulsing blink until update completes	TV is doing something.
Remote command received	Dims on/off once	TV has received your command.
Network connection lost	Two short blinks, pause, repeat	TV was connected and paired with a Roku account and now has no network connection.
Powering down to standby mode	Slow pulsing blink until the TV reaches standby.	TV is doing something.

## Standby mode energy savings

When you turn off your TV, it remains in a higher power mode for a few minutes, after which it goes into a very low power standby mode. If you turn on the TV again before it has entered the very low power mode, it turns on immediately. After the TV goes into the lower power standby mode, it takes a few seconds longer to start up.

*Only in connected mode*, you can optionally enable **Fast TV start [Inicio rápido de TV]**. When this option is enabled, your TV starts up almost immediately regardless of how long it has been turned off, but uses somewhat more power in standby mode. For more information, see [Fast TV start](#).

## Watching Antenna TV channels

Select the **Antenna TV [TV por antenna]** tile in the Home screen. Your TV remembers the last channel you watched and starts with that channel playing.

### Changing channels

To change channels, you can do any of the following:

- Press the **UP** arrow to change to the next higher channel.
- Press the **DOWN** arrow to change to the next lower channel.
- Press the **LEFT** arrow to display the channel list, and then press the arrow keys to select the channel or show you want to watch. Press **REWIND** ◀ and **FAST FORWARD** ▶ to move through the list one page at a time. When you've highlighted the channel or show you want to watch, press **OK**. (If you decide you don't want to change channels, press **BACK** ←).
- *Only if Live TV Pause is not enabled*, press ↻ to jump to the previous channel. Press again to return to the channel you were watching before you pressed ↻.

**Note:** *If the ↻ button is not available on your remote, you can use this feature in the Roku mobile app. For more information, see [Getting and using the Roku mobile app](#).*



## Favorite Channels

You can quickly change from surfing among all channels or only your favorite channels. First, you have to mark one or more channels as your favorites.

### Mark your favorite channels

You can make any channel a favorite whenever you're watching Antenna TV channels.

1. Press the **LEFT** arrow to display the channel list. Notice that the words **All channels [Todos los canales]** appear at the top of the channel list.
2. Scroll up or down to highlight a channel that you want to make a favorite.
3. Press **\***. At this point, you'll see two options:
  - **Add to favorites [Agregar a Favoritos]**
  - **Back [Volver]**
4. With **[Agregar a Favoritos]** highlighted, press **OK**. A  symbol appears adjacent to the channel to indicate that it is now a favorite.
5. Repeat these steps to add more favorite channels.

### Surf only your favorite channels

After you've marked one or more channels as favorites, you can switch to your favorite channels whenever you're watching Antenna TV channels.

1. Press the **LEFT** arrow to display the channel list.
2. Press the **LEFT** or **RIGHT** arrow once to switch to **Favorites [Favoritos]**. Notice that the word **Favorites [Favoritos]** appears at the top of the channel list.
3. Highlight a channel and press **OK** to select one of the channels in the **Favorites [Favoritos]** channel list, or wait a few moments until the channel list disappears.
4. Press the **UP** or **DOWN** arrow to change to the previous or next favorite channel. Each channel you select in this way is a favorite channel. Your channel surfing is limited to favorite channels only.

Your favorite channel list remains in effect even if you turn off or unplug your TV, until you switch back to all channels.

Note that when you press **OK** to view the program information banner while watching a show, a  symbol appears below the channel number.

## Surf all channels again

You can switch back to all channels whenever you're watching Antenna TV channels.

1. Press the **LEFT** arrow to display the channel list.
2. Press the **LEFT** or **RIGHT** arrow once to switch to **All channels [Todos los canales]**. Notice that the words **All channels [Todos los canales]** appear at the top of the channel list.
3. Highlight a channel and press **OK** to select one of the channels in the **All channels [Todos los canales]** list, or wait a few moments until the channel list disappears.
4. Press the **UP** or **DOWN** arrow to change to the previous or next channel among all your available channels. You can surf among all channels in your channel list.

## Remove a channel from your favorites

You can remove a channel from your favorites whenever you're watching the Antenna TV input.

1. Press the **LEFT** arrow to display either channel list—**All channels [Todos los canales]** or **Favorites [Favoritos]**.
2. Scroll up or down to highlight a favorite channel that you want to remove from your favorites.
3. Press **\*** on your remote. At this point, you'll see two options:
  - **Remove from favorites [Eliminar de Favoritos]**
  - **Back [Volver]**
4. With **Remove from favorites [Eliminar de Favoritos]** highlighted, press **OK**. The  symbol adjacent to the channel disappears.
5. Repeat these steps to remove other channels from Favorites.

## Viewing program information

To view information about the current program, press **OK**. The TV displays a banner at the bottom of the screen with as much information as is available in the program data stream. The following illustration shows the information that is available:



### Program information banner

Program information might include any or all of the following, depending on availability within the broadcast information:

- Channel number
- Channel call sign
- Favorite channel icon 
- Signal strength
- Program title and episode name/number
- Start time, end time, and graph of program length showing current position
- Content rating
- Video resolution (480i, 480p, 720p, 1080i, 1080p, 4K)
- Frame rate (24Hz, 30Hz, 60Hz for television sources, 60Hz, 70Hz, 72Hz, 75Hz for computer sources)
- Audio format (Mono, Stereo, Dolby Audio™ logo)
- Audio features (SAP/MTS)
- Only on select 4K models: HDR or Dolby Vision™\* logo (HDMI® and streaming sources)
- Closed captioning [Subtítulos] (CC)
- Current time

---

\* The Dolby Vision™ logo appears only on Dolby Vision™-certified models when displaying Dolby Vision™ content.

- Program description. If the entire description does not fit, press OK to expand the size of the banner and see the entire description.

**Tip:** *If you've set up Live TV Pause and you're watching Antenna TV, you'll also see a progress bar showing the current playback position within the rolling 90-minute pause time. For more information, see [Pausing Live TV](#).*

## Adjusting settings while watching a show

Press **\*** to display the **Options [Opciones]** menu (except when you are viewing the program information banner). Press the **UP** and **DOWN** arrows to highlight an option, and then press the **LEFT** and **RIGHT** arrows to change the setting. The topic [Adjusting TV settings](#) explains each of the settings in detail.

## Pausing Live TV

Live TV Pause gives your Roku TV the ability to pause, play, fast forward, and rewind digital Antenna TV. You can pause Antenna TV for up to 90 minutes.

## Requirements

To use this feature, you need to:

1. Connect your TV to the Internet. If you didn't connect during Guided Setup, see [What if I didn't connect my TV?](#)
2. Provide your own dedicated USB flash drive (thumb drive) with the following minimum specifications.
  - 16 GB
  - 15 Mbps read/write speed
  - USB 2.0 compliant

A USB flash drive (thumb drive) meeting the minimum requirements is highly recommended over an externally-powered hard disk drive. Note that you can use any larger size drive—there is no limit to the maximum size—but using a larger drive does not extend the 90 minute pause time.

**Important:** *After warning you and giving you a chance to cancel Live TV Pause setup, all existing content on your USB drive is erased when you enable this feature.*

3. Connect your USB drive to the TV's USB port.

**Important:** *Some TV models have more than one USB port. You can connect your Live TV Pause USB drive to any port, but make sure that nothing is connected to other USB ports while enabling Live TV Pause. Reconnect other USB devices after you have finished enabling Live TV Pause.*

4. Enable Live TV Pause, as explained in the following topic.

## Enabling Live TV Pause

You can start setting up Live TV Pause in any of the following ways:

- After completing a channel scan, select **Set up Live TV Pause [Configurar Pausa de TV en vivo]** from the available options.
- Press **Play/Pause** on the Roku remote while watching a digital Antenna TV channel.
- Highlight the Antenna TV tile on the Home screen, press **\*** on the remote, and then select **Set up Live TV Pause [Configurar Pausa de TV en vivo]**.

After starting setup of Live TV Pause in any of these ways, the TV prompts you through the steps needed to enable this feature. Setup takes only a few moments.

**Note:** *Use of a USB hub is not supported.*

## Using Live TV Pause

If you have used the Roku remote to watch streaming channels, using Live TV Pause should be very familiar to you.

- While watching a digital Antenna TV channel, press **PLAY/PAUSE** to pause or play the content. After the TV program has been paused for 90 minutes, the TV resumes playing.
- After watching a channel for a while, press **REWIND**  to jump back up to the point where you first started watching the channel, up to 90 minutes.

- After pausing or rewinding, press **FAST FORWARD** ►► to jump ahead up to the point where you are once again watching the live TV program.
- Press **FAST FORWARD** ►► or **REWIND** ◀◀ repeatedly to cycle through 1x, 2x, and 3x skip speeds. Press **REPLAY** ↺ to play back the last several seconds of the program.
- When the program is paused, press the **LEFT** and **RIGHT** arrows to move forward and backward through the program approximately 10 seconds per press. Small frames appear across the screen to identify your location in the program.

**Note:** If the ↺ button is not available on your remote, you can use the Roku mobile app. For more information, see [Getting and using the Roku mobile app](#).

Whenever you use any of the Live TV Pause features, the TV momentarily displays a progress bar:

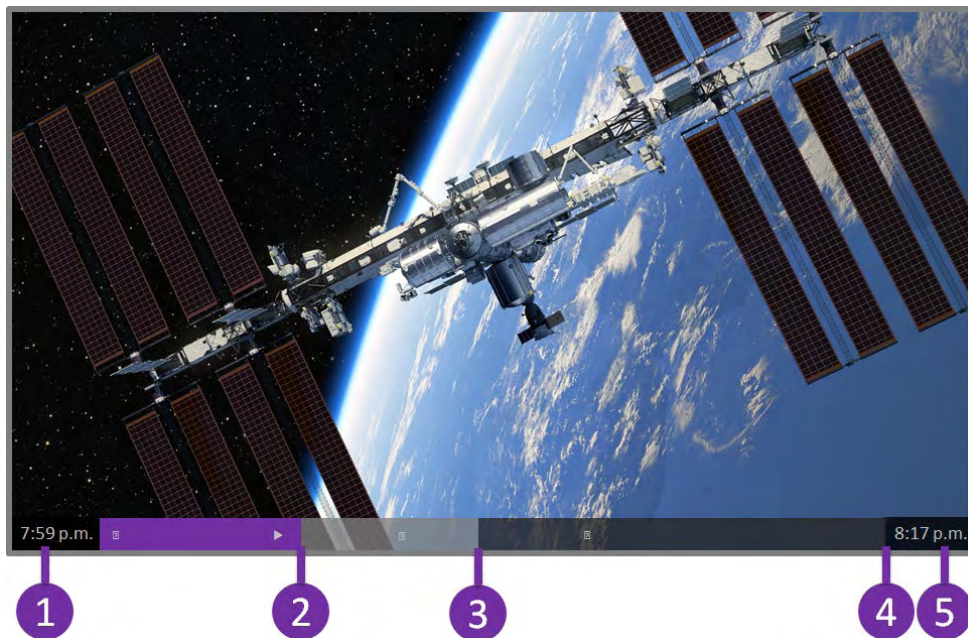

1. Time at current playback position.
2. Current playback position
3. Extent of pause time, representing the amount of time this channel has been buffered, up to 90 minutes.
4. 90 minute mark, representing the maximum extent of pause time.
5. Current time.

The progress bar also displays tick marks at each half hour point, to help you locate the boundaries where one show ends and a new one begins.

## Notes about Live TV Pause

- You can use Live TV Pause only with digital broadcast and cable channels received through the TV's ANT input (ATSC and Clear QAM channels).
- Changing channels erases and restarts the Live TV Pause buffer.
- Returning to the Home screen, selecting another input, or turning off the TV erases and resets the Live TV Pause buffer.
- Disconnecting the USB drive erases the Live TV Pause buffer.

## Switching TV inputs

Switch TV inputs to access the device connected to that input, for example, a Blu-ray™ player. Switching inputs is as simple as highlighting the input's tile in the Home screen, and pressing **OK**. The video signal on the input, if any, plays on the screen.

**Tip:** *To learn how to add, remove, rename, and rearrange the tiles on your Home screen, see [Customizing your TV](#).*

## Auto-detecting devices

Your TV automatically detects when you connect a new device to an HDMI® input and turn on its power. The input is automatically added to the Home screen if it isn't already present.

## Adjusting audio/video settings

While watching video content on any input, press **\*** to display the **Options [Opciones]** menu. Press the **UP** and **DOWN** arrows to highlight an option, and then press the **LEFT** and **RIGHT** arrows to change the setting. To learn about each of the audio and video settings, see [Adjusting TV settings](#).



# Playing content from USB storage devices

*Only in connected mode*, your Home screen has the **Roku Media Player [Reproductor de medios Roku]** tile. Otherwise, the Home screen has the **USB Media Player [Reproductor de medios USB]** tile. You can play personal music, video, and photo files from a personal USB flash drive or hard disk connected to the TV's USB port.

To use this feature, make sure your media files are compatible with the Roku/USB Media Player. To see the latest list of supported formats, view **Help [Ayuda]** in the Media Player\*. The Roku/USB Media Player displays supported file types only, and hides file types it knows it cannot play.

For more information about playing back your personal videos, music, and photos, go to the following link on the Roku web site:

[go.roku.com/rokumediaplayer](http://go.roku.com/rokumediaplayer)

## Auto player launch

*Only in connected mode*, you can set your TV to automatically open the Roku Media Player when you connect a USB drive with a recognizable file system (such as FAT16/32, NTFS, HFS+ or EXT2/3). To configure this setting, from the Home screen, navigate to **Settings [Configuración] > System [Sistema] > USB media**. At this point, the following options are available:

- **Auto-launch [Inicio automático]** – Choose **Prompt [Indicación]**, **On [Activado]**, or **Off [Apagado]**, as desired.
  - **Prompt [Indicación]** (*wondering if this is the correct translation for “prompting someone to do something”?*) – (default) Display a prompt each time a recognized USB drive is connected. The prompt provides options to launch the Roku Media Player as well as to change future auto-play behavior.
  - **On [Activado]** – Always launch the Roku Media Player whenever you connect a recognized USB drive.

---

\* There are many variants of each supported media format. Some variants may not play at all or may have issues or inconsistencies during playback.



- **Off [Apagado]** – Never launch the Roku Media Player automatically.
- **Launch channel [Iniciar canal]** – Choose the app you want to use to play back media files.

## Playing content from local network media servers

*Only in connected mode*, your TV can play personal video, music, and photo files from a media server on your local network. Media servers include personal computers running media server software such as Plex or Windows Media Player, network file storage systems that have built-in media server software, and other devices that implement the specifications of the Digital Living Network Alliance. Some servers do not fully implement the DLNA specification but are UPNP (Universal Plug and Play) compatible. The Roku Media Player will connect to them as well.

Some media servers can convert files into Roku compatible formats. DRM-protected content is not supported.

## Setting up a payment method

For Movie Store, TV Store, and other channels that allow you to pay through your linked Roku account, you can enter a payment method directly on your TV. Entering a payment method on your TV means that you don't need to go to a computer or mobile device to set up a payment method.

To add a payment method:

1. From the Home screen menu, navigate to **Settings [Configuración] > Payment method [Método de pago] > Add payment method [Agregar método de pago]**.
2. Use the on-screen number pad to enter your credit/debit card number, expiration date, CVV number, and postal code.
3. Select **Save Card [Guardar tarjeta]**, and then press **OK**.

To manage your saved payment method and to see other payment methods, log into your account at [go.roku.com/pay](https://go.roku.com/pay).

## Using your TV in a hotel or dorm room

Hotels, school dorms, conference facilities, and similar locations with public wireless Internet access often require you to interact with a web page to authenticate your access. These types of networks are called *restricted public networks*. When you select a network of this type, the TV automatically detects that additional information is needed and prompts you through using another wireless device to supply the requested information.

### About using your TV on a restricted public network

Here are some points to keep in mind when using your TV on a restricted public network:

- Using your Roku TV on a hotel or dorm room network requires wireless availability and a network-connected smartphone, tablet, or computer to authenticate access to your wireless access point.
- You will need your Roku TV remote.
- Some content might be limited or unavailable if you try to connect outside your home country due to geo-filtering.

### Getting your Roku TV on line on a restricted public network

1. Either during Guided Setup or after using the **Settings [Configuración] > Network [Red]** menu to set up a new connection, the TV automatically detects

that you are connecting to a restricted network and displays the following prompt:

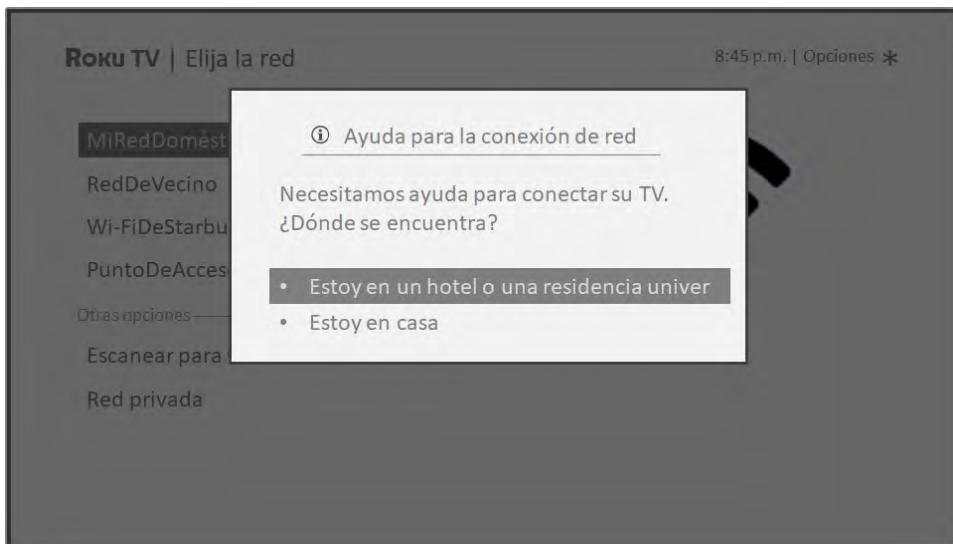

**Tip:** Your TV can connect to a restricted network only if **Enable 'Device connect' [Habilite 'Conectar dispositivo']** is selected in **Settings [Configuración] > System [Sistema] > Advanced system settings [Configuración avanzada]**. (**Device connect [Conectar dispositivo]** is enabled by default, but if you have disabled it, the TV cannot complete the connection.)

**Note:** **Device connect [Conectar dispositivo]** is not present if the TV is in non-connected mode.

2. After selecting the correct network, highlight **I am at a hotel or college dorm [Estoy en un hotel o una residencia]**, and then press **OK**. The TV prompts you to use your smartphone, tablet, or laptop to complete the connection.

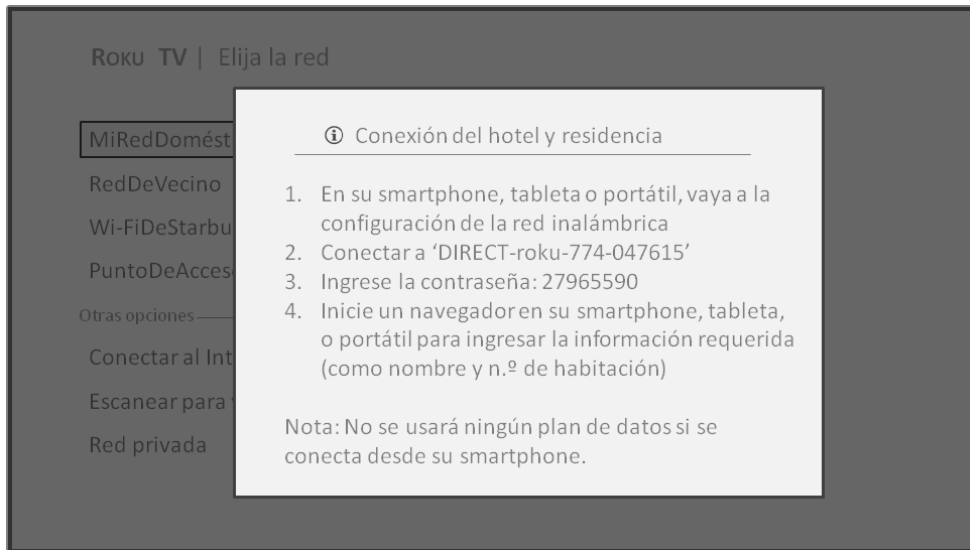

3. Use a phone, tablet, or wireless-enabled computer to detect wireless networks. In most cases, you can simply open the device's Wi-Fi Settings or Network Settings screen to start scanning.

**Note:** *The phone, tablet, or computer must be on the same wireless network to which you are connecting the TV.*

4. Connect to the network named on your TV screen. The actual network name varies.

**Note:** *The previous step connects your smartphone, tablet, or computer directly to the TV. No connection charges apply and the connection does not impact your device's data plan.*

5. The wireless connection process prompts you for a password. Enter the password as shown on the TV screen. The actual password varies.
6. Start the web browser on your smartphone, tablet, or computer. When you attempt to open any web page, the restricted connection will prompt you for whatever information it needs. In most cases, you must agree to terms and conditions, provide identifying information, or enter a password, PIN, or room

number to proceed. The information requested depends on the organization that controls the wireless connection.

7. After you enter the requested information, the TV automatically proceeds to complete its connection and resumes normal operation.
8. If the TV prompts you to link to your Roku account, use your smartphone, tablet, or computer to complete the pairing operation and activate your Roku TV.

## Roku voice remotes (select models only)

*Only on TVs with the Roku voice remotes:* The following topics explain how to get the most out of your TV when it includes a Roku Voice Remote.

### Re-pairing your Roku voice remote

Roku voice remotes operate with wireless radio-frequency signals and must be paired with your TV. You initially paired the remote when you set up your TV during Guided Setup. But if your remote loses its pairing with the TV for some reason, you can easily re-pair it using either of the following methods:

1. Remove the battery cover from the back of the remote.
2. Press and hold down the pairing button for 3 seconds or longer, until the adjacent LED lights up.
3. Do one of the following:
  - Turn on the TV using the power button on the TV side or back panel. Pairing occurs as the TV starts up.
  - Use the Roku mobile app or a different remote to navigate to **Settings > Remotes & devices > Pair new device > Remote**.

**Tip:** *If the remote fails to pair with the TV, try installing new batteries. Also, it's helpful to hold the remote within two to three feet of the TV to ensure successful pairing.*

## Checking the Roku voice remote battery level

You can check the condition of the batteries in your Roku voice remote at any time by navigating to **Settings > Remotes & devices**, and then pressing **OK** to select your remote below **My paired devices**. With your remote selected, navigate right to **About > Remote** to view its **Battery level**. The resulting screen displays not only the battery level, but also other information that can be useful when you need technical support with your remote.

**Tip:** *When you first turn on the TV, a battery level indicator appears in the upper right corner of the screen for a few seconds.*

# Adjusting TV settings

You can adjust most picture and sound settings while you are watching a program by pressing **\*** to open the **Options [Opciones]** menu. There are some additional picture and sound settings in the **Settings [Configuración]** menu.

In most cases, the changes you make apply only to the input you are using. Antenna TV, the separate HDMI® inputs, and the AV input each have their own settings that the TV remembers when you return to that input. The TV also separately remembers the settings you specify while viewing streaming content.

## Settings menu

Use the **Settings [Configuración]** menu to adjust overall TV settings. Press  to go to the Home screen, and then navigate to **Settings [Configuración] > TV picture settings [Config. de imagen de TV]**.

You can adjust the following overall TV picture settings from the **Settings [Configuración]** screen:

- **TV brightness [Brillo de TV]** – Provide a better viewing experience in darker or brighter rooms. Increases or decreases the TV's general brightness across all TV inputs.

**Note:** *This setting is identical to the **TV brightness [Brillo de TV]** setting you can access in the **Options [Opciones]** menu while watching a program.*

- **HDR notification [Notificación de HDR]** – *On select models only.* Controls whether the TV displays a notification in the upper right corner of the screen for a few seconds when HDR or Dolby Vision content begins to play.
  - **On [Activado]** – The TV displays a notification when HDR or Dolby Vision content begins to play.
  - **Off [Apagado]** – The TV does not display a notification when HDR or Dolby Vision content begins to play.

**Note:** *This setting does not affect the HDR or Dolby Vision notification that always appears in the program information banner. Press **OK** while watching a show to open the program information banner.*

- **Settings per input [Configuración por entrada]** – Lists each TV input. Select an input, and then press **\*** to display the **Options [Opciones]** menu where you can adjust the input’s settings while watching a live picture and listening to the sound from that input.

**Tip:** *You don’t have to go to the **Settings [Configuración]** menu first—you can display an input’s **Options [Opciones]** menu and adjust its settings whenever you are watching the input by pressing **\***.*

## Options menu

The **Options [Opciones]** menu for each TV input provides many settings for controlling the appearance of the picture and the quality of the audio. To view the **Options [Opciones]** menu, press **\*** whenever you are watching a TV input or streaming a video (except when you are viewing the program information banner).

The **Options [Opciones]** menu is a panel that appears over the left side of the screen:



Typical Options [Opciones] menu

To adjust the settings on the **Options [Opciones]** menu, press the **UP** or **DOWN** arrow to highlight a setting, and then press the **LEFT** or **RIGHT** arrow to change the



setting. You'll see the changes you make right away in picture appearance or audio quality.

**Tip:** *When you highlight a setting, the header text explains the effect of its current value. When you begin to adjust a setting, the other options are hidden so you can see more of the screen. Even though the other settings are hidden, you can move the highlight up or down to adjust the other settings. As soon as you press the **UP** or **DOWN** arrow, the other settings become visible again.*

**Note:** *Some streaming channels assign the **\*** button to a different function, meaning it will not open the **Options [Opciones]** menu. In these cases, use a different channel, such as The Roku Channel, to configure options. The selected settings remain active for all streaming channels.*

## Options menu settings

- **Sleep timer [Apagado program.]** – Sets a timer that turns off the TV after the specific amount of time. *This setting remains in effect even if you stop watching the current input.*
- **TV brightness [Brillo de TV]** – Affects the overall brightness of the picture. *This setting applies across the entire TV; that is, to all TV inputs and is identical to the **TV brightness [Brillo de TV]** setting under **Settings [Configuración] > TV picture settings [Config. de imagen de TV]**.*
- **Picture size [Tamaño de imagen]** – Adjusts the aspect ratio of the picture, enabling you to view a picture in its original format, or zoom or stretch it to fill the screen. The **Auto [Automático]** setting has been found to produce the best picture in most cases.
- **Picture mode [Modo de imagen]** – Provides picture presets for various viewing preferences. *This setting applies to the currently-selected input only.*
- **Sound mode [Modo de sonido]** – Adjusts the sound quality output from the TV speakers. *This setting applies across the entire TV; that is, to all TV inputs. It does not affect the sound quality for headphones, **HDMI (ARC)**, or **SPDIF (TOSLINK)** connectors.*

- **Closed captioning [Subtítulos]** – Controls when you see captions. *This setting is only offered for Antenna TV, the AV input, and streaming videos. Any set value remains in effect across only these inputs.*
  - **Antenna TV [TV por antenna]** – Set captions to off, always on, on only when the TV sound is muted, or on only during instant replay (when Live TV Pause has been enabled).
  - **AV input** – Set captions to off, always on, or on only when the TV sound is muted.
  - **Streaming video channel** – For streaming content that provides closed captions, set captions to off, always on, on only when the TV sound is muted, or on only during instant replay (for streaming content that supports instant replay). *Note that some streaming channels have other methods for turning captions on and off. In these cases, the **Closed captioning [Subtítulos]** option does not appear on the **Options [Opciones]** menu.*

**Note:** If the  button is not available on your remote, you can use this feature in the Roku mobile app. For more information, see [Getting and using the Roku mobile app](#).

- **Captioning track [Pista de subtulado]** – Selects which caption track to display when Closed Captioning is on. *This setting remains in effect on all inputs that provide captions.*
- **SAP** – Selects whether to play a secondary audio program or multichannel television sound, and which choice to play. *This setting applies only to Antenna TV on digital channels.*
- **Picture settings [Config. de imagen]** – Shows the [Picture settings](#) menu.
- **Audio settings** – *Only on select models:* Shows the [Sound settings](#) menu.

**Tip:** To dismiss the **Options [Opciones]** menu, just wait a few seconds without pressing any buttons. Or press **\*** again to dismiss the menu immediately.

# Picture settings

The **Picture settings [Config. de imagen]** menu for each TV input provides settings for fine tuning the appearance of the picture. All of the settings in this menu apply only to the currently-selected input.

To use the **Picture settings [Config. de imagen]** menu, first press **\*** to display the **Options [Opciones]** menu. Then select **Picture settings [Config. de imagen]**.

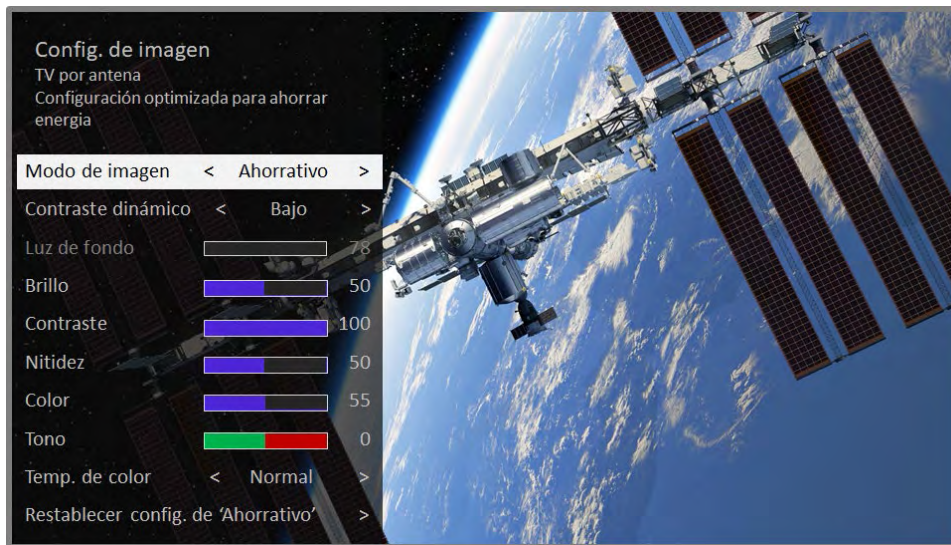

Typical Picture settings [Config. de imagen] menu

## Picture settings [Config. de imagen] menu options

**Note:** Picture settings vary by brand and model. Not all settings are available on all TVs. Names of certain settings also vary by brand and might differ from the names listed here.

- **Picture mode [Modo de imagen]** – Provides picture presets for various viewing preferences. This setting duplicates the one on the **Options [Opciones]** menu. When you change the **Picture mode [Modo de imagen]**, other picture settings adjust accordingly. For example, setting the **Picture mode [Modo de imagen]** to **Vivid [Vivido]** sets **Brightness [Brillo]**, **Contrast [Contraste]**, **Sharpness [Nitidez]**, and other values to produce a very vibrant picture. Setting **Picture mode [Modo de imagen]** to **Movie [Película]** changes the settings to produce a picture suitable for enjoying movies in a darkened room. If you make changes to the individual picture settings—for example, **Contrast [Contraste]**, or

**Sharpness [Nitidez]**—these settings are saved for the current input *and* the current picture mode. In this way, you can set **HDMI 1** input's **Movie [Película]** picture mode to use different settings than the **HDMI 2** input's **Movie [Película]** picture mode and Antenna TV's **Movie [Película]** picture mode. Use **Reset picture settings [Restablecer config. de imagen]**, described below, to return the input's selected picture mode to its original values.

- **Local dimming [Oscurecimiento local]** - *Only on select models:* Sets the amount of dimming multiple “local” areas of the screen’s backlight intensity. This setting can make dark areas darker without affecting the brightness of light areas.
- **Dynamic contrast [Contraste dinámico]** - *Only on select models:* Automatically adjusts the backlight level to achieve the optimum contrast and prevent excessive differences between light and dark areas of the screen.
- **Micro contrast [Microcontraste]** - *Only on select models:* Improves image contrast.
- **Backlight [Luz de fondo]** - Adjusts the overall light intensity of the screen.
- **Brightness [Brillo]** - Adjusts the dark level of the picture.
- **Contrast [Contraste] [Nitidez]**- Adjusts the white level of the picture.
- **Sharpness [Nitidez]**- Adjusts the sharpness of edges in the picture.
- **Color** - Adjusts the saturation of colors in the picture. A setting of 0 removes all color and displays a black and white picture.
- **Tint [Tono]** - Adjusts the color balance from green to red to obtain accurate colors in the picture.
- **Color temperature [Temp. de color]** - Adjusts the color tones in the picture from **Normal** to slightly more bluish (**Cool [Fría]**) to slightly more reddish (**Warm [Cálida]**).
- **Frame rate conversion [(This is not a UI term - translate as appropriate)]** - *Only on select models: Each TV brand uses a different name for this option.* Adjusts the amount of motion processing applied to the video signal. A higher

setting results in more smoothing, but can cause undesirable picture artifacts in certain types of content. *Each **Picture mode [Modo de imagen]** has a different default setting.*

- **Film mode** [*(This is not a UI term – translate as appropriate)*] – *Only on select models: Each TV brand uses a different name for this option.* When enabled, this feature reduces “judder” that is often present when 24 frame-per-second movies are upscaled to 60Hz TV standards. **Film mode** is **On [Activado]** by default in **Movie [Película]** and **HDR Dark [HDR Brillow bajo]** picture modes, and **Off [Apagado]** by default in other picture modes.
- **Blur reduction** [*(This is not a UI term – translate as appropriate)*] – *Only on select 120Hz models: Each TV brand uses a different name for this option.* Reduces blur, especially for fast-moving images such as sports.
- **Black frame insertion** [*(This is not a UI term – translate as appropriate)*] – *Only on select models that also have the local dimming feature. Each TV brand uses a different name for this option.* Reduces motion blur caused by the refresh rate of the screen. Enabling this feature inserts black frames between picture frames in a way that improves the clarity of fast moving objects. It provides an improved viewing experience for video games and sporting events, but reduces the brightness of the picture. You can choose settings of **Low [Bajo]**, **Medium [Media]**, **High [Alto]**, or **Off [Apagado]** to achieve the desired picture quality.
- **Game mode [Modo de juego]** – *Only on HDMI® and AV inputs:* Controls whether Game mode is enabled. When **On [Activado]**, the TV performs less image processing and has less input lag. When **Off [Apagado]**, the TV performs more image processing and has more input lag, which is less desirable for action games.

*Only on select models:* Auto Low Latency Mode (ALLM) detects when certain game consoles are connected to an HDMI input, and automatically configures the best settings for action games. When ALLM is active, the manual **Game mode [Modo de juego]** setting is not available.

- **Reset picture settings [Restablecer config. de imagen]** – Returns all picture settings for the input’s currently-selected **Picture mode [Modo de imagen]** to their original values.

**Tip:** To dismiss the **Picture settings [Config. de imagen]** menu, just wait a few seconds without pressing any buttons. Or press **\*** again to dismiss the menu immediately.

## Sound settings

Select TV brands and models have various sound settings available in the **Options [Opciones]** menu. Variations include:

- No sound settings
- [Volume modes](#)
- [Dolby® Audio Processing](#)
- [DTS® TruSurround](#)
- [DTS® Studio Sound](#)
- [Sonic Emotion™ Premium](#)

## Volume modes [Modos de volumen] (select models only)

To access Volume modes, first press **\*** to display the **Options [Opciones]** menu, then select **Sound settings [Config. de sonido]**\*

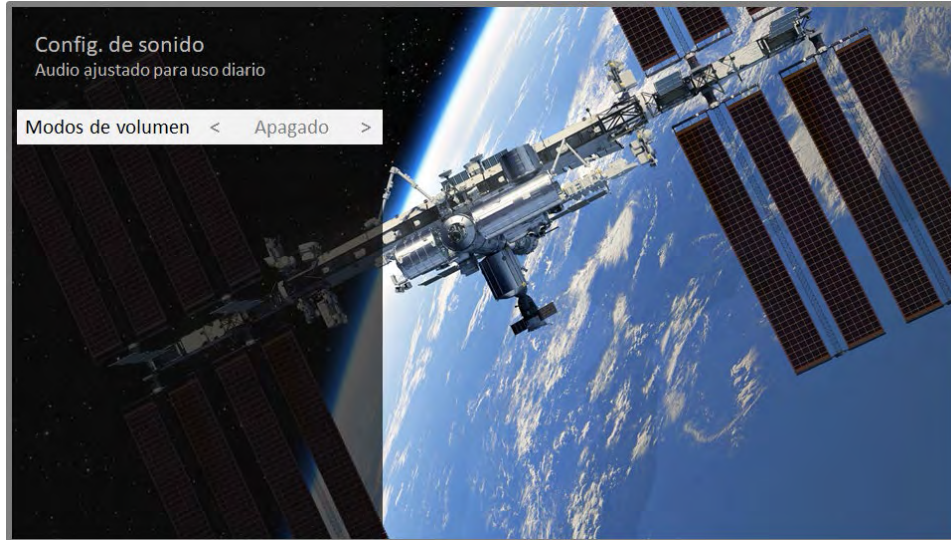

Sound settings [Config. de sonido] menu for models with Volume modes [Modos de volumen]

**Tip:** Some streaming channels assign the **\*** button to a different function, meaning it will not open the **Options [Opciones]** menu. In these cases, use a different channel, such as The Roku Channel, to set the Volume mode. The selected mode remains active for all streaming channels.

### Sound settings menu - Volume modes [Modos de volumen]

- **Off [Apagado]** – Volume modes are inactive and content volume is unmodified.
- **Leveling [Nivelación de volumen]** – Provides a consistent volume level across different types of content, so that you need not change the volume every time you switch channels or when a commercial comes on.
- **Night [Modo nocturno]** – Soft sounds, such as whispers, are increased while loud sounds, such as explosions, are decreased, making it easier to hear your TV at night without disturbing others.

---

\* On some models the **Volume modes [Modos de volumen]** option is in the **Options** menu rather than in **Sound settings [Config. de sonido]**.



## Sound settings – Dolby® Audio Processing (select models only)

Each TV input has separate settings for fine tuning sound quality. All of the settings in this menu apply only to the currently-selected input. To access the DAP settings, first press **\*** to display the **Options [Opciones]** menu, then select **Sound settings [Config. de sonido]**.

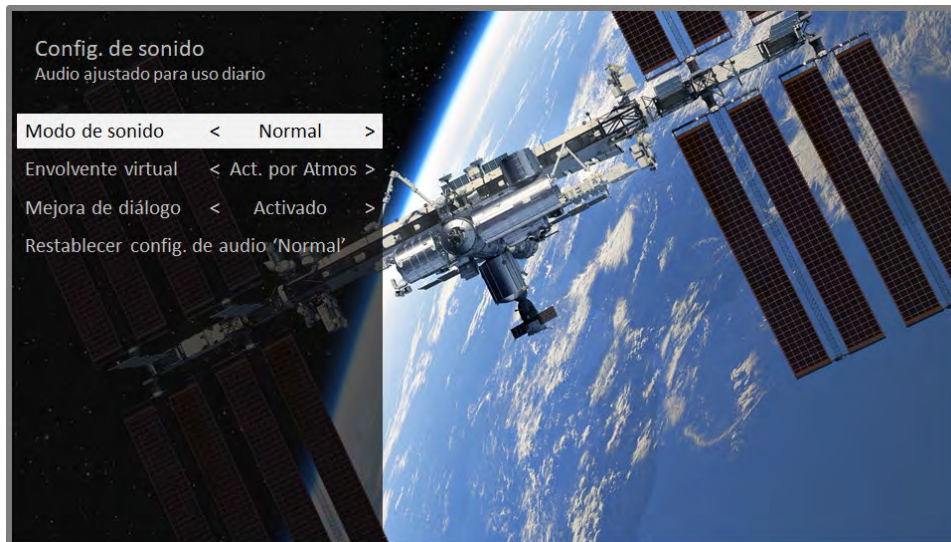

Sound settings menu for models with Dolby® Audio Processing

**Tip:** Some streaming channels assign the **\*** button to a different function, meaning it will not open the **Options [Opciones]** menu. In these cases, use a different channel, such as The Roku Channel, to configure Dolby® Audio Processing. The selected settings remain active for all streaming channels.

### Sound settings menu- Dolby® Audio Processing

- **Sound mode [Modo de sonido]** – Select from among various preset sound modes to improve speech, make music sound its best, boost bass or treble, or simulate a theater. Use **Reset audio settings [Restablecer config. de audio]**, described below, to return the input's current settings to their original values.
- **Virtual surround [Sonido envolvente virtual]** (select models only) – Options vary by TV model. Simulates surround sound that otherwise would require installation of a surround sound audio system. Sometimes, the effect interferes with dialog clarity. Use the **Dialog enhancer** option to compensate.
- **Dialog enhancer [Potenciador de diálogo]** – Improves the clarity of speech when on.



- **Reset audio settings [Restablecer config. de audio]** – Returns **Virtual surround [Sonido envolvente virtual]** and **Dialog enhancer [Potenciador de diálogo]** settings to their default settings for the selected **Sound mode [Modo de sonido]**.

## Sound settings – DTS® TruSurround / DTS® Studio Sound (select models only)

This topic describes the **Sound settings [Config. de sonido]** menu for TV models with DTS TruSurround. Each TV input has separate settings for fine tuning sound quality. All of the settings in this menu apply only to the currently-selected input. To use the **Sound settings [Config. de sonido]** menu, first press **\*** to display the **Options [Opciones]** menu. Then select **Sound settings [Config. de sonido]**.

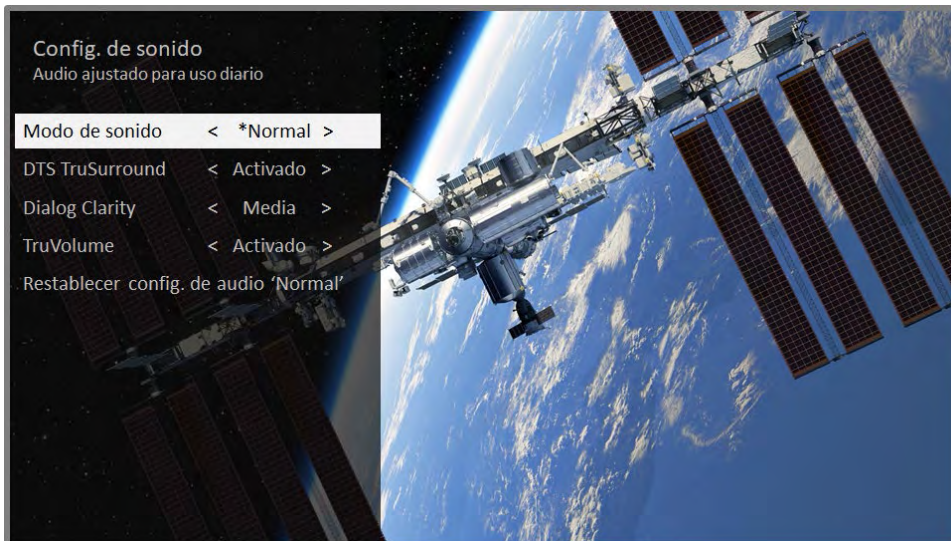

Sound settings [Config. de sonido] menu for models with DTS® TruSurround/Studio Sound

### Sound settings menu options – DTS® TruSurround / DTS® Studio Sound

- **Sound mode [Modo de sonido]** – Select from among various preset sound modes to improve speech, make music sound its best, boost bass or treble, or simulate a theater. Use **Reset audio settings [Restablecer config. de audio]**, described below, to return the input's current settings to their original values.
- **DTS TruSurround [(Do not translate)]** – Simulates surround sound that otherwise would require installation of a surround sound audio system.

Sometimes, the effect interferes with dialog clarity. Use the **Dialog Clarity** option to compensate.

- **Dialog Clarity** [*(Do not translate)*] – Available only when **DTS TruSurround** is **On [Activado]**. Choose among **Low [Bajo]**, **Medium [Media]**, and **High [Alto]** settings to improve the clarity of dialog when you are using the TruSurround feature.
- **TruVolume** [*(Do not translate)*] – Minimizes annoying volume fluctuations in programs.
- **Reset audio settings [Restablecer config. de audio]** – Returns **DTS TruSurround, Dialog Clarity,** and **TruVolume** settings, to their default settings for the selected **Sound mode [Modo de sonido]**.

## Sound settings – Sonic Emotion Premium (select models only)

This topic describes the **Sound settings [Config. de sonido]** menu for TV models with Sonic Emotion Premium. Sonic Emotion Premium is an audio technology that enables your TV to produce a more immersive sound experience. Each TV input has separate settings for fine tuning sound quality. All of the settings in this menu apply only to the currently-selected input. To use the **Sound settings [Config. de sonido]** menu, first press **\*** to display the **Options [Opciones]** menu. Then select **Sound settings [Config. de sonido]**.

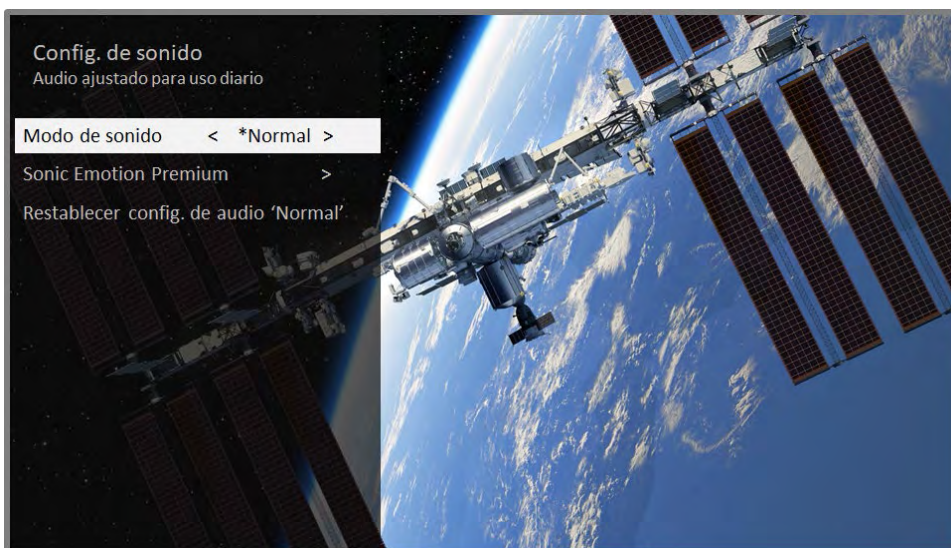

Sound settings [Config. de sonido] menu for models with Sonic Emotion Premium

## Sound settings menu options – Sonic Emotion Premium

- **Sound mode [Modo de sonido]** – Select from among various preset audio modes to improve speech, make music sound its best, boost bass or treble, or simulate a theater. Use **Reset audio settings [Restablecer config. de audio]**, described below, to return the input's current settings to their original values.
- **Sonic Emotion Premium [(Do not translate)]** – Displays a menu with individual Sonic Emotion audio settings, as described in [Sonic Emotion](#).
- **Reset audio settings [Restablecer config. de audio]** – Returns **Sonic emotion [(Do not translate)]** settings to their default settings for the selected **Sound mode [Modo de sonido]**.

## Sonic Emotion settings

When you turn on **Sonic Emotion [(Do not translate)]** from the **Sound settings [Config. de sonido]** menu, these additional settings become available:

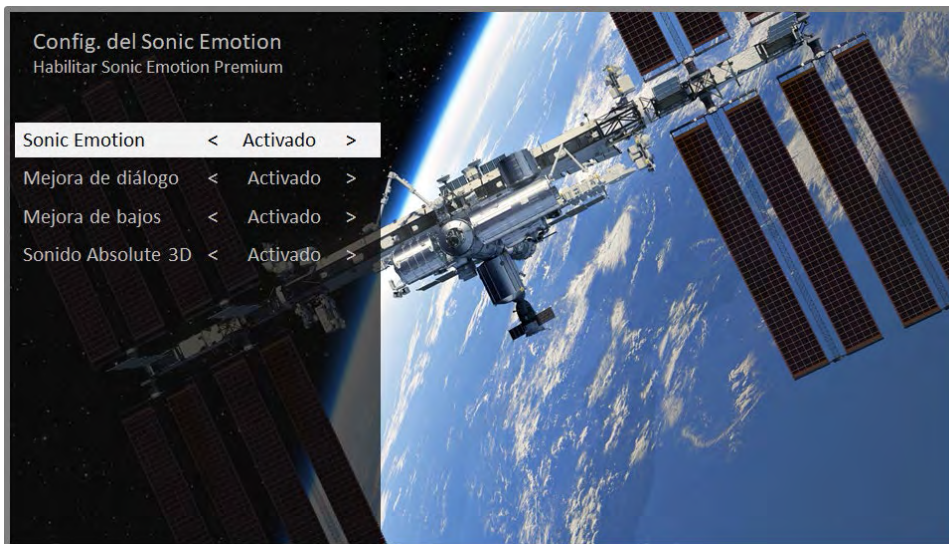

- **Dialog Enhancement [Mejora de diálogo]** – Enhances your ability to hear and understand dialog in the program.
- **Bass Enhancement [Mejora de bajos]** – Enhances the low frequency sound component in the program.

- **Absolute 3D Sound [Sonido Absolute 3D]** – Simulates sound from multiple speakers that would otherwise require installation of a surround sound audio system.

## Expert Picture Settings (4K models only)

4K (UHD) TV models have additional picture settings for demanding home theater enthusiasts. Expert Picture Settings include gamma, noise reduction, 11-point white balance adjustment, and extended color space management.

You can access Expert Picture Settings only by using the Roku Mobile App on an iOS® or Android™ mobile device. For more information, go to the following link on the Roku web site:

[go.roku.com/expertpicturesettings](https://go.roku.com/expertpicturesettings)

## Changing privacy settings

**Note:** *Privacy settings are not present on TVs operating in non-connected mode.*

### Advertising

*Only in connected mode*, by default your TV uses an advertising identifier to track your TV usage. You can change the privacy settings on your TV in two ways: resetting the advertising identifier and limiting ad tracking.

#### Reset the advertising identifier

Resetting the advertising identifier clears the prior usage history that your TV stores, and then begins tracking again. From that point forward, your new usage patterns affect the advertisements you see on your TV.

1. From the Home screen menu, navigate to **Settings [Configuración] > Privacy [Privacidad] > Publicidad**.
2. Highlight **Reset advertising identifier [Restablecer el ident. de anuncios]**. Press **\*** to view more information about this option. When you finish reading the information, press **OK** to close the More Information window.

3. Press **OK** to reset the advertising identifier, and then press **OK** again to dismiss the verification message.

## Limit ad tracking

You can limit Roku's tracking of your usage behavior by limiting ad tracking. When you do, your TV will display ads that are not personalized based on your TV's advertising identifier.

1. From the Home screen menu, navigate to **Settings [Configuración] > Privacy [Privacidad] > Publicidad**.
2. Highlight **Limit ad tracking [Límite de seguimiento de anuncios]**. Press **\*** to view more information about this option. When you finish reading the information, press **OK** to close the More Information window.
3. Press **OK** to select the **Limit ad tracking [Límite de seguimiento de anuncios]** check box.

**Note:** *If you perform a factory reset and then reconnect your TV, ad tracking is restored until you repeat these steps.*

## Microphone

Your Roku TV does not have a built-in microphone. However streaming channel providers can use the microphone on the Roku voice remotes (only on select models) or on your mobile device when the Roku mobile app is running. You can control whether streaming channels have permission to use the microphone.

**Note:** *These settings affect only streaming channel access to the microphone.*

## Channel microphone access

You can control which streaming channels have permission to use the microphone, giving you control over how the microphone is used by each streaming channel. The default setting is **Prompt [Indicación]**, so channels will not be able to turn on the microphone without your permission.

To change microphone access settings:

1. From the Home screen menu, navigate to **Settings [Configuración] > Privacy [Privacidad] > Microphone**.
2. Select **Channel microphone access [Acceso de micrófono]**.
3. Choose one of the following settings:
  - **Prompt [Indicación]** – Display a notification the first time a streaming channel requests the use of the microphone. When such a notification appears, you can choose either **Allow microphone access [Permitir]** or **Deny microphone access [Denegar]** on a per-channel basis. If you choose to allow microphone access, you'll be prompted to confirm your choice by entering a numeric code that appears on the screen.
  - **Always allow [Permitir siempre]** – Do not prompt, but always allow any streaming channel to use the microphone.
  - **Never allow [No permitir nunca]** – Do not prompt, but never allow any streaming channel to use the microphone.

## Channel permissions

After granting or denying microphone access on a per-channel basis, you can reset channel permissions to enable them to follow the system-wide setting you specify under [Channel microphone access](#).

To reset channel permissions:

1. From the Home screen menu, navigate to **Settings [Configuración] > Privacy [Privacidad] > Microphone [Micrófono]**.
2. Select **Channel permissions [Permisos de canales]**.
3. Highlight **Reset channel permissions [Restablecer los permisos del canal]**, or highlight a specific listed channel, and then press **OK** to deny microphone access to all or to a specific channel.



# Searching for something to watch

Searching for movies and shows across multiple streaming channels is one of the unique features of your Roku TV. Within a single search operation, you can search by:

- Movie name
- TV show name
- Actor name
- Streaming channel name
- Interactive game name

**Note:** *Roku Search is not available if your TV is operating in non-connected mode. Roku Search doesn't search across all streaming channels, but searches across lots of popular streaming channels. The actual channels it searches vary by locale.*

## How do I search?

You can search by using an on-screen keyboard that you navigate using the arrow keys on your remote or the on-screen keyboard in the Roku mobile app.

### Keyboard search using the remote

1. Select **Search [Buscar]** on the Home screen.
2. Use the arrow keys to navigate the on-screen keyboard, entering a few characters of the search term.

With each additional character you enter, you narrow down the search, making the search results more relevant. You'll often see the results you are seeking after entering only a few letters.

3. When you see the show you are searching for, press the **RIGHT** arrow to highlight it. Continue pressing the RIGHT arrow to see more details about how to watch the show.

## Searching from the Roku mobile app

Use the free Roku mobile app on your compatible smartphone or tablet to make searching even faster. Use your mobile device's keypad to type more quickly and easily than with the on-screen keyboard on your TV.

When you use the Roku mobile app to search, search results are shown on your mobile device instead of on the TV screen. When you make a selection from the search results, the TV starts playing the selected program.

For more information, see [Roku mobile app](#).

## I found a show, now what?

Now that you've highlighted the show, movie, actor, game, or streaming channel you were looking for, press the **RIGHT** arrow.

If your search result was an actor, director, or other item that does not represent a single item of content, you'll see another list to narrow down your search. Continue highlighting results and pressing the **RIGHT** arrow until you find a single, viewable content item.





- The streaming channel logo appears to the left of each result.
- **HD** means that the content is available in high-definition.

If your search result was a game or a streaming channel, you'll see detailed information, images, and available actions, such as a list of streaming channels and the cost of getting the item or channel.

**Note:** *Some channels may require a paid subscription.*

## Recent Searches

The next time you use Roku Search, the **Search [Buscar]** screen displays a list of recent search selections in place of the search instructions.

Using the recent search selections list makes it easy to quickly get to a previously found item, for example, to find another movie with the same actor, or another TV show in the same series.

# Using the Roku Channel Store

*Only in connected mode*, the **Streaming Channels [Canales de transmisión]** menu option takes you to the Roku Channel store, where you can add new subscription based and free streaming channels to your TV.

To make it easier to find what you want, the streaming channels in the Roku Channel Store are categorized by topic. Press the **UP** and **DOWN** arrows to highlight the category you want, and then press the **RIGHT** arrow to move the highlight into the grid of streaming channel tiles.

When you find a streaming channel you want to add or learn more about, highlight it and press **OK** to display more details.

- If the streaming channel you are adding is free, you can select **Go to channel [Ir a canal]** to start watching it immediately.
- If there is a one-time or recurring fee associated with using the streaming channel, you must agree to the terms and conditions, accept the fee, and—if you created one when you activated your Roku TV, enter your Roku PIN code to authorize the charges.
- If you already have a subscription to the streaming channel—for example, you already subscribe to Netflix or you receive HBO through your cable TV provider—you must complete a different, simple authorization step to add the streaming channel.

You need only complete the authorization or activation step one time, when you initially add the streaming channel. After that, you simply select the streaming channel tile from your Home screen to start watching. (Channel and content availability are subject to change. Charges may apply to your selection.)

**Tip:** *New streaming channels are added continuously to the Roku Channel Store, so be sure to check back every now and then for new options.*

**Note:** *If you don't remember your PIN, or if you want to change whether you need to use a PIN to make purchases on your Roku account, see [Roku account PIN](#).*

# Customizing your TV

There are several things you can do to personalize your TV.

## Add TV inputs

As you use your TV, you might find that you need to add a TV input tile that you did not add during Guided Setup. To add a TV input:

1. From the Home screen menu, navigate to **Settings [Configuración] > TV inputs [Entradas de TV]**. Notice that the list of inputs is divided into two sections: **Inputs being used [Entradas en uso]** and **Inputs not used [Entradas no en uso]**.
2. Press the **UP** or **DOWN** arrows to highlight an input in the **Inputs not used [Entradas no en uso]** section of the list.
3. Press the **RIGHT** arrow to move the highlight to Set up input.
4. Press **OK** to add the input.
5. Press  to return to the Home screen. Notice that the input has been added to the top of the Home screen. If you want to move the input tile to a different position in the grid, see [Rearrange tiles](#).

## Add streaming channels

You can add streaming channels by searching in the Roku Channel Store. New streaming channels are added to the bottom of the Home screen. If you want to move the channel tile to a different position in the grid, see [Rearrange tiles](#).

## Rename inputs

Rather than trying to remember that your Blu-ray™ player is connected to **HDMI 1** and your game console is connected to **HDMI 3**, you can rename the TV inputs to match the connected device.

**Note:** *Renaming an input also changes the icon associated with it.*

To rename an input, you can either:

- Highlight the input tile in the Home screen, and then press **\*** to display a list of options. From the list of options, select **Rename input [Renombrar entrada]**. Then select a new name and icon.

or

- From the Home screen, navigate to **Settings [Configuración] > TV inputs [Entradas de TV]**. On the **TV inputs [Entradas de TV]** screen, select the input you want to rename, select **Rename [Renombrar]**, and then choose a new name and icon from the provided list.

Rather than using the predefined names and icons, you can set a custom name and icon. To do so, scroll up or down to highlight **Set custom name & icon [Nombre personalizado...]**, and then press **OK**. Follow the instructions on the screen to enter a name and select an icon for the input.

Press  to return to the Home screen. The new name and icon are now in effect.

## Remove unwanted tiles

It's easy to remove unused TV inputs and unwanted channel or app tiles. For example, if you never use the **HDMI 3** input, or if you don't like the weather app you added from the Roku Channel Store, you can remove them from your Home screen.

**Note:** *You also can remove the **Antenna TV [TV por antenna]** tile if you never use the TV tuner. But be aware that removing the Antenna TV tile also deletes the channel list. You'll have to set up the TV tuner again next time you want to view Antenna TV. Instructions for setting up the TV tuner can be found in [Setting up Antenna TV](#).*

- To remove any tile, highlight the input tile in the Home screen, and then press **\*** to display a list of options. From the list of options, select **Remove input [Eliminar entrada]**. In the screen that follows, confirm you want to remove the input.
- Alternatively, to remove a TV input tile from the Home screen, navigate to **Settings [Configuración] > TV inputs [Entradas de TV]**. On the **TV inputs [Entradas de TV]** screen, select the input you want to remove, and then select **Remove [Eliminar] > Confirm [Confirmar]**. Then press  to return to the Home screen.

## Rearrange tiles

When you add a TV input tile, it's added at the top of your Home screen. When you add a new streaming channel, it's added at the bottom of your Home screen.

You can easily rearrange the order of the tiles on the Home screen to suit your viewing preferences. For example, you might want **Antenna TV [TV por antenna]** to be the first tile in your Home screen. But if you mostly watch one streaming channel, you might want its tile to be the first one on your Home screen.

1. From the Home screen, highlight one of the tiles you want to move.
2. Press **\*** to display a list of options for the type of tile you selected.
3. Select **Move input [Mover entrada]** or **Move channel [Mover canal]**. The list of options disappears and the highlighted tile shows arrows indicating how it can be moved.

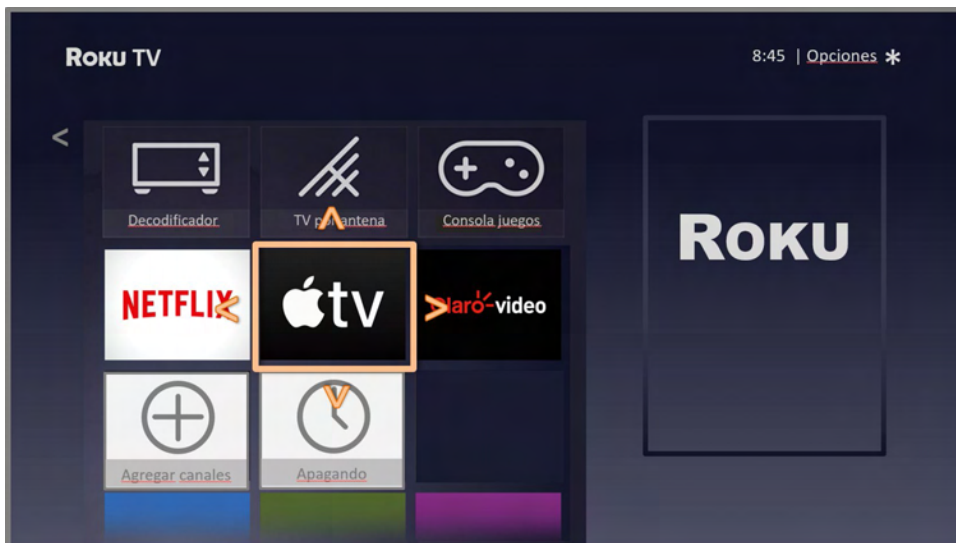

**Note:** *A paid subscription or other payments may be required for some channels. Channel availability is subject to change and varies by country. Not all content is available in countries or regions where Roku® products are sold.*

4. Use the arrow keys to move the highlighted tile to its new position. As you move the tile, it pushes other tiles out of its way.
5. Press **OK** to lock the tile into its new position.

6. Repeat these steps to move other tiles until you have arranged your Home screen to your liking.

## Change themes

*Only in connected mode*, another way to customize your TV is to change its theme. The theme establishes the look and feel of the TV through colors, designs, and fonts. Some themes require payment.

To change the theme, from the Home screen menu navigate to **Settings [Configuración] > Theme [Tema] > Change theme [Buscar temas]**. In the **Themes [Temas]** screen, choose from the following options:

- In the **My Themes [Mis temas]** section, highlight one of your themes, and then press **OK** to switch to that theme.
- In the **All Themes [Todos los temas]** section, highlight a new theme, and then press **OK** to preview and add it.

To change enable or disable **Featured themes [Temas destacados]**, from the Home screen menu, navigate to **Settings [Configuración] > Theme [Tema] > Custom settings [Configuración personalizada]**, and then, press **OK** to set or clear the check box next to **Enable featured themes [Activar temas destacados]**. When **Featured themes [Temas destacados]** is enabled, the TV automatically switches to featured themes—like certain holiday-inspired themes—for a limited time whenever Roku makes them available, and then switches back to your selected theme when the featured theme expires. When off, the TV uses your selected theme.

## Change screensaver

*Only in connected mode*, you can change what your TV displays after a period of inactivity.

To change the screensaver, from the Home screen menu, navigate to **Settings [Configuración] > Screensaver [Salvapantalla] > Change screensaver [Buscar salvapantallas]**. In the **Screensavers [Salvapantallas]** screen, choose from the following options:



- In the **My Screensavers [Mis salvapantallas]** section, highlight one of your screensavers, and then press **OK** to switch to that preview, change settings, rate, and select that screensaver.
- In the **All Screensavers [Todos los salvapantallas]** section, highlight a new screensaver, and then press **OK** to add it.

To disable your screensaver, or to change the inactive time before it starts, from the Home screen menu, navigate to **Settings [Configuración] > Screensaver [Salvapantalla] > Change wait time [Cambiar el tiempo de espera]**. Select the desired option, and then press **OK**.

## Edit Antenna TV channel lineup

When you set up the TV tuner as described in [Setting up Antenna TV](#), the TV adds all the channels with good signals that it can detect in your area. It's likely that you now have more channels than you want in your channel list.

To edit the channel lineup, from the Home screen, navigate to **Settings [Configuración] > TV inputs [Entradas de TV] > Antenna TV [TV por antena] > Edit channel lineup [Editar la lista de canales]**. You'll see a screen listing all of your channels. Adjacent to the list of channels is a miniature TV screen playing the highlighted channel's picture and sound.



Highlight each channel you want to hide, and then press **OK** to hide the channel.

**Tip:** *If you need to see or hear the highlighted channel, wait a couple of seconds for the TV to start playing the channel's picture and sound. Also note that if you've enabled parental controls and the program on the current channel is blocked, you won't see a picture or hear sound while editing the channel lineup.*

**Note:** *Repeating the tuner channel scan unhides all hidden channels.*

## Change menu volume

Menu sounds are the noises the TV makes to let you know it received your command. You can change the volume of these menu sounds or turn them off.

To adjust the menu volume, in the Home screen menu, navigate to **Settings [Configuración] > Audio [Audio] > Menu volume [Volumen del menú]**. Navigate to the right and then change the setting to **Low [Bajo]**, **Medium [Media]**, **High [Alto]**, or **Off [Apagado]**.

# Configure power settings

Power settings let you configure features related to how your TV's power settings work.

## Power on settings

Power on settings tell the TV what to do when you turn on the power. To configure the power on settings, from the Home screen, navigate to **Settings [Configuración] > System [Sistema] > Power [Energía] > Power on [Encendido]**. Highlight the preferred power on location in the list, and then press **OK**.

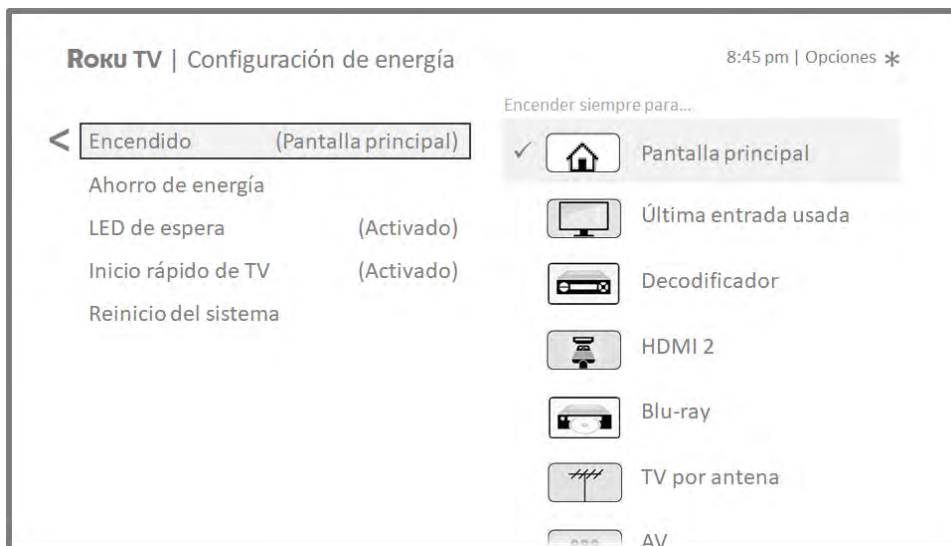

## Auto power savings

To help you save energy, your TV can automatically turn itself off after a period of inactivity or a period during which no signal has been detected. It is factory-configured to do both of these things, but you can change these settings if needed.

To configure automatic power off, from the Home screen menu navigate to **Settings [Configuración] > System [Sistema] > Power [Energía] > Auto power savings [Ahorro de energía]**. In the **Power settings [Configuración de energía]** screen, highlight the following options and press **OK** to turn them on or off:

- **Reduce power after 15 minutes [Reducir energía después de 15 min.]** – If no video or audio activity and no user interaction occur for 15 minutes, the TV automatically turns off the screen and sound.
- **Turn off after 4 hours [Apagar después de 4 horas]** – If no video or audio activity and no user interaction occur for 4 hours, the TV goes into standby mode.

## Standby LED On/Off

Normally, the status indicator is lit whenever the TV is in standby mode. If you prefer the status indicator to not be lit in standby mode, you can turn it off. To do so, from the Home screen, navigate to **Settings [Configuración] > System [Sistema] > Power [Energía] > Standby LED [LED de espera]**, and then select **Off [Apagado]**.

After making this change, the status indicator still performs all other indication functions.

## Fast TV start

*Only in connected mode on TV models,* you can enable **Fast TV start [Inicio rápido de TV]**. As you might expect, **Fast TV start [Inicio rápido de TV]** lets you start watching your TV almost instantly after turning it on. But it also enables other convenient features, such as listening to certain music channels with the TV screen off.

Be aware that enabling Fast TV start makes your TV use somewhat more power when it is powered off to standby mode.

# Changing caption settings

You can find caption settings under **Settings [Configuración] > Captions [Subtítulos]**.

- **Off [Apagado]** – No captions appear.
- **On [Activado]** – Captions appear whenever they are available from the program source.
- **On replay [En repetición]** – Captions appear only when you use the replay option, and only when you are watching a streaming program that supports instant replay.
- **On mute [En silencio]** – Captions appear only when the TV is muted.

## Tips

- *You can change the captions mode while watching a program. Press **\*** to display the **Options [Opciones]** menu, and then select **Closed Captioning [Subtítulos]**.*
- *Some streaming channels require you to enable captions through a setting within their channel even though you have turned on captions everywhere else.*

**Note:** *Once enabled, the captions mode applies to all inputs that support captions and remains enabled until you turn it off.*

## Captions preferred language [Idioma preferido para los subtítulos]

Choose the language in which you want closed captioning to appear, when that language is available. If your preferred language is not available, then captioning reverts to the default language for the program, which usually is English.

Highlight the language you prefer, and then press **OK** to select it.

## Other caption settings

- **Text style [Tipo de texto]** - Choose from a list of fonts. As you move the highlight to each font, you can see a sample of the result in an adjacent panel.
- **Text edge effect [Borde de texto]** - Choose from a list of edge effect styles, such as raised, depressed, and various shadows. As you move the highlight to each effect, you can see a sample of the result in an adjacent panel.
- **Text size [Tamaño de texto]** - Choose from a list of sizes. As you move the highlight to each size, you can see a sample of the result in an adjacent panel.
- **Text color [Color de texto]** - Choose from a list of colors for the text. As you move the highlight to each color, you can see a sample of the result in an adjacent panel.
- **Text opacity [Opacidad de texto]** - Choose from a list of opacity settings for the text. This setting determines how much the area behind the text shows through the text. A value of 100% blocks all of the content behind the text. As you move the highlight to each setting, you can see a sample of the result in an adjacent panel.
- **Background color [Color de fondo]** - Choose from a list of colors for the background area behind the text. As you move the highlight to each color, you can see a sample of the result in an adjacent panel. Note that you won't see any change unless you set the **Background opacity [Opacidad de fondo]** to a value other than **Off [Apagado]**.
- **Background opacity [Opacidad de fondo]** - Choose from a list of opacity settings for the background of the caption. This setting determines how much the area behind the caption background shows through the background. A value of 100% blocks all of the content behind the background. As you move the highlight to each setting, you can see a sample of the result in an adjacent panel.
- **Window color [Color de Ventana]** - Choose from a list of colors for the window rectangle surrounding the entire caption. As you move the highlight to each color, you can see a sample of the result in an adjacent panel. Note that you won't see any change unless you set the **Window opacity [Opacidad de Ventana]** to a value other than **Default (set by content) [Predeterminado (por contenido)]** or **Off [Apagado]**.

- **Window opacity [Opacidad de Ventana]** - Choose from a list of opacity settings for the window rectangle surrounding the entire caption. This setting determines how much the area behind the caption window shows through the window. A value of 100% blocks all of the content behind the window. As you move the highlight to each setting, you can see a sample of the result in an adjacent panel.

## Customize the Home screen

If you prefer to not see shortcuts on the Home screen, you can hide them.

To hide Shortcuts:

1. From the Home Screen menu, navigate to **Settings [Configuración] > Home screen [Pantalla principal]**, and then press the **RIGHT** arrow.
2. Select **Shortcuts [Accesos directos]**.
3. Highlight **Hide [Ocultar]**, and then press **OK**.

## Configure parental controls

Parental controls enable you to control whether the members of your household can view certain kinds of broadcast TV programs. When a program or feature is blocked, you can unblock it by entering a parental control PIN that only you know.

**Note:** *Parental controls block content from the TV tuner and from streaming options, if any, on the Home screen menu. Parental controls do not block content on other TV inputs or content from streaming channels you add to your TV.*

### Creating a parental control PIN

The first time you access the **Parental controls [Control parental]** screen, you must create a new parental control PIN. Thereafter, whenever you want to change parental control settings, unblock programming that has been blocked, change the PIN, or disable parental controls, you must enter your parental control PIN.

**Tip:** *Your parental control PIN has nothing to do with your Roku account PIN. You can make them the same if you want—this is entirely your choice.*

To create a new parental control PIN, from the Home screen menu navigate to **Settings [Configuración] > Parental controls [Control parental]**. The screen displays a numeric keypad. Use the arrow keys and then press **OK** to enter a four-digit code. Then repeat the process to enter the same PIN again, just to make sure you correctly entered the PIN you want to use.

**Important:** *If you forget your parental control PIN, the only way to recover is to perform a factory reset operation, as explained in [Factory reset everything](#). Be sure to write it down in a safe place just in case.*

## Blocking Broadcast TV shows

For broadcast TV, parental controls use information embedded in the broadcast signal to determine whether to allow a program to be displayed. Parents can configure parental controls to block broadcast TV programs that meet or exceed a specific rating, so they cannot be viewed or heard unless the correct parental control PIN is entered.

**Note:** *Rating standards differ by country.*

### Enabling parental control of TV shows

The first step in blocking TV shows is to enable parental control of TV shows.

This setting is provided separately to make it easier for you to turn parental control of TV shows on and off without disturbing their settings. For example, your kids are going to summer camp for two weeks, and while they are gone, you don't want to have to deal with unblocking shows that you want to watch by entering your parental control PIN. All you need to do is clear **Enable parental controls [Activar el control parental]**, and all TV shows are unblocked. When the kids return, select **Enable parental controls [Activar el control parental]** again, and all of your parental control settings are restored in a single operation.

To enable parental control of TV shows:

1. In the Home screen menu, navigate to **Settings [Configuración] > Parental controls [Control parental]**, and then enter your parental control PIN.
2. In the **Parental controls [Control parental]** screen, navigate to **TV tuner [Sintonizador] > Enable parental controls [Activar el control parental]**.



3. Make sure the check box next to **Enable parental controls [Activar el control parental]** is checked. If not, highlight it and press **OK**.

### Blocking based on US TV ratings

Most broadcast US TV shows—other than movies—contain rating data that enables parental controls to block shows that parents don't want others to view. The ratings are divided into two groups that function independently:

- **Youth group** [*(Not a UI item - translate as appropriate)*] - TV-Y, TV-Y7
- **Main group** [*(Not a UI item - translate as appropriate)*] - TV-G, TV-PG, TV-14, TV-MA

Within each of these groups, the ratings interact such that if you block a particular level of content, the TV also blocks all content with a higher rating. Conversely, if you unblock a particular level of content, the TV also unblocks all content with a lower rating. For example, if you block TV-PG programs, the TV also blocks TV-14 and TV-MA programs. If you subsequently unblock TV-14 programs, TV-PG programs are also unblocked, but TV-MA programs remain blocked.

Similarly, within the main group, content types can be individually blocked. For example, you can block just coarse language in shows with a TV-PG rating. If you do, then the TV also blocks shows with coarse language in the higher ratings (TV-14 and TV-MA). Subsequently unblocking coarse language in TV-14 ratings does not unblock coarse language in TV-MA programs, but it does unblock coarse language in TV-PG programs.

To block TV shows based on US television ratings:

1. From the Home screen menu, navigate to **Settings [Configuración] > Parental controls [Control parental]**, and then enter your parental control PIN.
2. In the **Parental controls [Control parental]** screen, navigate to **TV tuner [Sintonizador] > TV ratings [Clasificaciones de TV]**. Choose among the following settings:
  - **Entire ratings** [*(Not a UI item - translate as appropriate)*] - Highlight the rating you want to block, and then navigate to the right and select the first option that blocks the entire rating level (and all higher rating levels).

- **Individual content types** [*(Not a UI item – translate as appropriate)*] – Highlight the rating that contains the content type you want to block, and then select the content types you want to block from among those listed. Remember that blocking a content type in one rating blocks the equivalent content type in all higher rating levels.

## Blocking based on US movie ratings

Most movies in the US are rated by the Motion Picture Association of America, or MPAA, so the ratings are known as MPAA ratings. TV broadcast signals carry movie rating data that enables parental controls to block shows that parents don't want others to see. The ratings are:

- G – General audiences
- PG – Parental guidance suggested
- PG-13 – Parents strongly cautioned for children age 13 or younger
- R – Restricted
- NC-17 – Not for age 17 or younger

Unlike US TV ratings, there are no individual content types within the ratings. But like TV ratings, blocking movies with a particular rating also blocks movies with a higher rating, and unblocking movies with a particular rating also unblocks movies with a lower rating.

**Tip:** *Blocking movies with an NC-17 rating also blocks programs with the now-obsolete X rating, which can still occur in the program data of older movies.*

To block movies based on MPAA ratings:

1. From the Home screen menu, navigate to **Settings [Configuración] > Parental controls [Control parental]**, and then enter your parental control PIN.
2. In the **Parental controls [Control parental]** screen, navigate to **TV tuner [Sintonizador] > Movie ratings [Clasificaciones de películas]**.
3. Select the rating level you want to block. You need only select one rating level, and all higher levels are automatically blocked.

## Blocking based on Other ratings

Your TV can block programs having ratings that had not been defined when the TV was manufactured. It does this by detecting a new Rating Region Table in a program and then downloading the new table and displaying its rating in the Parental controls.

When the TV downloads a new Rating Region Table, it adds a new option to the list of rating types: **Other ratings [Otras clasificaciones]**. If you see this option in the **Parental controls [Control parental]** screen, you have tuned to a station that has implemented a new rating table. Once the new rating table has been downloaded to the TV, it remains in the TV until it is factory reset, and you can configure blocking based on the new ratings.

New Region Rating Tables can have independent rating levels, or rating levels that interact in the same ways as the built-in US TV and MPAA Movie ratings.

**Tip:** *If your TV downloads a new Region Rating Table, you'll have to experiment with its settings to understand how to use it.*

## Blocking based on Canadian English ratings

Canadian-English language and third-language programs that are broadcast in Canada are rated by the Action Group on Violence on Television, or AGVOT. TV broadcast signals carry rating data that enables parental controls to block shows that parents don't want others to view based on content containing violence, language, sex, or nudity. The ratings are:

- C - Children under 8 years
- C8 - Children 8 years and older
- G - Generally suitable for all age groups
- PG - Parental guidance suggested for viewers under 14 years
- 14+ - Generally not suitable for viewers under 14 years
- 18+ - Generally not suitable for viewers under 18 years

Blocking content with a particular rating also blocks content with a higher rating, and unblocking content with a particular rating also unblocks movies with a lower rating.

To block programs based on AGVOT ratings:

1. From the Home screen menu, navigate to **Settings [Configuración] > Parental controls [Control parental]**, and then enter your parental control PIN.

2. In the **Parental controls [Control parental]** screen, navigate to **TV tuner [Sintonizador] > Canadian English ratings [Sistema canadiense inglés]**.
3. Select the rating level you want to block. You need only select one rating level, and all higher levels are automatically blocked.

## Blocking based on Canadian French ratings

Canadian-French language programs that are broadcast in Canada are rated by Québec's Ministry of Culture and Communications. TV broadcast signals carry rating data that enables parental controls to block shows that parents don't want others to view based on content containing violence, language, sex, or nudity. The ratings are:

- G - Generally suitable for all age groups
- 8+ - Viewers 8 years and older
- 13+ - Viewers 13 years and older
- 16+ - Viewers 16 years and older
- 18+ - Adults only

Blocking content with a particular rating also blocks content with a higher rating, and unblocking content with a particular rating also unblocks movies with a lower rating.

To block programs based on Canadian-French ratings:

1. From the Home screen menu, navigate to **Settings [Configuración] > Parental controls [Control parental]**, and then enter your parental control PIN.
2. In the **Parental controls [Control parental]** screen, navigate to **TV tuner [Sintonizador] > Canadian French ratings [Sistema canadiense francés]**.
3. Select the rating level you want to block. You need only select one rating level, and all higher levels are automatically blocked.

## Blocking unrated programs

Some broadcast TV shows and movies do not have an assigned rating, and are considered to be "Unrated". Whether or not such programs contain content that is objectionable to you cannot be determined. However, you can choose to block such programs.

To block all unrated broadcasts:

1. From the Home screen menu, navigate to **Settings [Configuración] > Parental controls [Control parental]**, and then enter your parental control PIN.
2. In the **Parental controls [Control parental]** screen, navigate to **TV tuner [Sintonizador] > Block all unrated programs [Bloquear todos sin clasificación]**.
3. Highlight **Block all unrated programs [Bloquear todos sin clasificación]** and press **OK**. When blocking is enabled, the adjacent padlock icon changes from unlocked to locked.

**Tip:** *Blocking programs that have not been assigned a rating does not block programs that specifically have been assigned a US TV rating of “None” (for example a broadcast of a local town council meeting). Programs that do not have an assigned rating display **Rating NA [Clasificación ND]** (for “not applicable,” meaning a rating is not needed).*

*In the absence of other ratings for a program, the parental controls do not consider the MPAA US movie rating N/A (MPAA rating not applicable to this content) and **NR [ND]** (applicable content not rated by the MPAA) to be ratings. In these cases, the TV handles the program as though it is unrated, blocking the program if **Unrated [Sin clasificación]** programs blocking is enabled.*

## What happens when a TV show is blocked?

After you've set up parental controls, TV shows and movies can be blocked:

- When you change channels and the new channel is playing a program whose rating exceeds your settings.
- When a new show comes on the channel you are watching and its rating exceeds your settings.

When a program is blocked by parental control settings, the TV displays a blocked message:

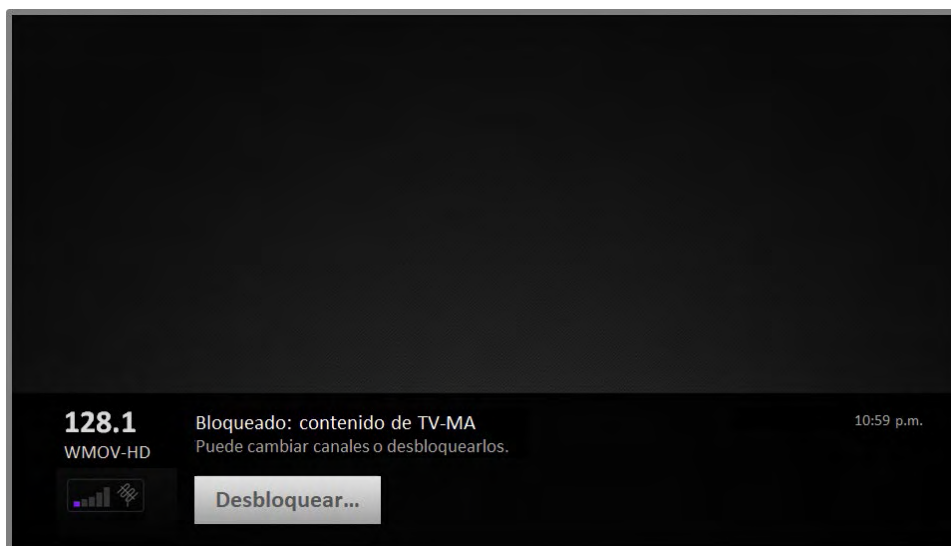

Whenever this blocked message appears, both the video and audio of the show are blocked, as well as program data that would normally appear in the area at the bottom of the screen.

To watch the blocked program, you need to know the PIN code defined when you enabled parental controls, as explained in [Creating a parental control PIN](#).

1. Press **OK** to select **Unblock [Desbloquear]** and display a PIN pad.

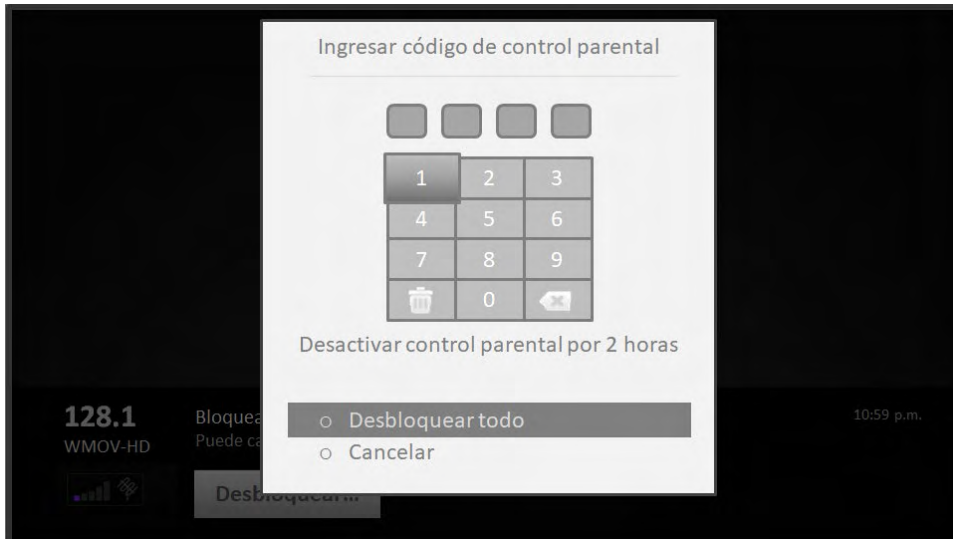

2. Use the arrow keys to enter your parental control PIN code, and then press **OK** to select **Unblock everything [Desbloquear todo]**.

After unblocking shows that have been blocked, all blocking is disabled for two hours or until you turn off the TV.

## Changing the parental control PIN

To change your parental control PIN:

1. From the Home screen menu, navigate to **Settings [Configuración] > Parental controls [Control parental]**, and then enter your parental control PIN.
2. In the **Parental controls [Control parental]** screen, highlight **Change PIN [Cambiar el Código]**.
3. Move the highlight into the adjacent keypad, and then use the arrow keys and then press **OK** to enter a four-digit code. Then repeat the process to enter the same PIN again, just to make sure you correctly entered the PIN you want to use.

## Resetting parental controls

So now your kids have grown up and gone away to college, and you no longer want to deal with blocked programs.

To erase all parental control settings:

1. From the Home screen menu, navigate to **Settings [Configuración] > Parental controls [Control parental]**, and then enter your parental control PIN.
2. In the **Parental controls [Control parental]** screen, highlight **Reset parental controls [Restablecer el control parental]**.
3. Follow the instructions on the screen to confirm that you want to erase all parental control settings.

**Tip:** *Resetting parental controls also erases your parental control PIN.*



# More settings

This section describes the features and settings of the TV that were not covered in the other parts of this guide.

## Guest Mode

*Only in connected mode*, when you enable Guest Mode, your guests can sign in to subscription channels using their own account credentials instead of using yours. Your guests' credentials are then automatically removed on the date they specify.

By enabling Guest Mode, your guests won't have access to your personal streaming channel accounts and won't be able use your Roku account to make purchases. Instead, your guests can safely access their own subscription channels. And they won't have to remember to sign out before they leave.

To enable Guest Mode:

1. From the Home screen menu, navigate to **Settings [Configuración] > System [Sistema] > Guest Mode [Modo de invitado]**.
2. Select **Enter Guest Mode [Entrar Modo de invitado]**.
3. Use the on-screen keypad to enter your Roku account PIN.
4. Select **OK** to confirm and put the TV into Guest Mode.

**Note:** You also can enable and disable Guest Mode remotely by going to [my.roku.com](https://my.roku.com) on your computer or smart phone, scrolling down to **My linked devices [Mis dispositivos vinculados]**, and selecting **Enable Guest Mode [Habilitar el modo invitado]** or **Disable Guest Mode [Deshabilitar el modo invitado]**, respectively.

After you put your TV into Guest Mode, it is ready to welcome your guests, allowing them to select a sign-out date. On the home screen, they will find an assortment of default subscription channels They can enjoy free content from The Roku Channel and many others, or sign-in and watch movies and TV shows from their own subscriptions and saved content libraries. Your guests can use the Roku Channel

Store to find and add channels they watch at home with confidence that they automatically will be removed on their sign-out date.

For more information about the experience your guests will have when Guest Mode is enabled, see:

<https://support.roku.com/article/360015612834--how-do-i-set-up-auto-sign-out-mode-for-my-guests->

To disable Guest Mode:

1. Press the **Home** button to return to the Home screen menu.
2. Navigate to **Settings [Configuración] > System [Sistema] > Guest Mode [Modo de invitado]**.
3. Select **Exit Guest Mode [Salir del modo de invitado] > Sign out now [Cerrar sesión ahora]**
4. Use the on-screen keypad to enter your Roku account PIN.
5. Select **OK** and confirm that you want to disable Guest Mode.

After you disable Guest Mode, all of your original settings are restored and your channels are reinstalled. You might need to sign in to your subscription channels again to access your content.

**Note:** Any game data that was stored on your Roku device is not restored.

## Network settings

If needed, you can change your network settings at any time. For example, if you change the name of your wireless network (its SSID) or its password, you will need to change your TV's settings so that it can continue to connect. Also, if you decided not to connect to the Internet in [Guided Setup](#), you can use network settings to connect at a later time.

To change network settings, from the Home screen menu, navigate to **Settings [Configuración] > Network [Red]**, and then press the **RIGHT** arrow. At this point, you can choose the following options:

- **About [Acerca de]** – Lists important information about your current network connection, such as status, connection type, IP addresses, and MAC address.

This information is often useful when contacting customer support with connection issues.

- **Check connection [Compruebe la conexión]** – Select your existing network connection type, and then press **OK** to start checking the network connection. The TV uses your current network information to reconfirm the wireless or wired network connection to the local network and the Internet connection.
- **Set up connection [Configure la conexión]** – Select a network connection type, and then select the option to set up a new connection. Follow the on-screen instructions to complete the network connection. For help with each of the steps, see [Network connection](#).

**Note:** *Some networks, such as those found in dorm rooms, hotels, and other public places, may require you to read and agree to terms, enter a code, or provide identifying information before letting you connect to the Internet. For more information, see [Using your TV in a hotel or dorm room](#).*

## Time settings

You can change time settings to suit your preferences. You can find the following settings by navigating from the Home screen menu to **Settings [Configuración] > System [Sistema] > Time [Hora]**:

- **Sleep timer [Apagado program.]** – Set a time delay after which the TV will automatically shut off. This setting reflects the setting you can make in the **Options [Opciones]** menu from any TV input, as explained in [Options menu settings](#). *Note that the sleep timer setting is not input specific, and also can be set by using the **Sleep timer [Apagado program.]** shortcut in the Home screen grid.*
- **Time zone [Zona horaria]** – Select whether to set the time zone automatically or manually, and if set manually, select your current time zone. Typically, a TV connected to the Internet can discover its own time zone automatically, and a TV that is not connected to the Internet must be set manually. Initially, this setting is made when you set up the TV tuner, as explained in [Setting up Antenna TV](#). Correct time zone information is needed to correctly display program data.

- **Clock format [Formato de reloj]** – Select whether to display time in a 12-hour or 24-hour format, or to turn off time display. *This setting is available only on TVs that are connected to the Internet. Non-connected TVs do not display the time.*

## Scan again for Antenna TV channels

There will be times when you need to create a new channel list. For example, you:

- Change cable providers
- Reorient your TV antenna
- Move to a different city with different channels

Whenever you need to update your TV channel list, you can repeat the channel scan.

**Tip:** *Repeat the channel scan from time to time to make sure you are receiving all of the latest channels. Broadcasters add and remove channels, move channels to different parts of the spectrum, and change the power levels of their channels periodically.*

**Note:** *Repeating the tuner channel scan unhides all hidden channels.*

To repeat the channel scan, from the Home screen menu, navigate to **Settings [Configuración] > TV inputs [Entradas de TV] > Antenna TV [TV por antenna] > Scan for channels [Escanear canales]**. Then select **Start finding channels [Comenzar a buscar canales]** to begin the channel scan process. The screens and options that appear during this process are identical to those described in [How do I set up the TV tuner?](#)

## HDMI® mode (4K models only)

On 4K (UHD) TVs, you can independently configure each HDMI® input to match the capabilities of the connected device. From the Home screen menu, navigate to **Settings [Configuración] > TV inputs [Entradas de TV]**, and then select an enabled

HDMI® input. Next, select **HDMI mode [Modo HDMI]** and then select one of the following settings:

- **Auto [Automático]** – Let the TV determine the best setting. Use this option unless your HDMI® device does not correctly communicate its HDMI® version compatibility.
- **HDMI 1.4** – Configure the input for compatibility with HDMI® version 1.4, which supports a maximum refresh rate of 30 Hz at full UHD resolution. Most HDMI® devices will work correctly with the TV in this mode.
- **HDMI 2.0** – Configure the input for compatibility with HDMI® version 2.0, which supports a maximum refresh rate of 60 Hz at full UHD resolution. You must use this mode to view HDR content from the device connected to this HDMI® input. However, note that many older HDMI® devices do not work correctly when the TV's HDMI® input is set to this mode.

## Control by mobile apps

You can choose the level of control you want to allow your TV to accept from external devices, such as smart phones, tablets, and virtual assistants. Device connect settings enable other devices, including the Roku Mobile App, to control your TV over the local area network in your home.

To adjust the level of external control access:

1. From the Home screen menu, navigate to **Settings [Configuración] > System [Sistema] > Advanced system settings [Configuración avanzada] > Control by mobile apps [Control mediante aplicaciones móviles]**.
2. Select **Network access [Acceso a la red]**.
3. Choose one of the following settings:
  - **Default [Predeterminado]** – Devices can connect only through a private network address, and accept commands only from other private network

addresses on your home network. This setting is suitable for most cases, including use of the Roku mobile app on your smartphone.

- **Permissive [Permisivo]** – Devices can connect under all conditions, but accept commands only from private network addresses or the same subnetwork within your home network. This setting might be required when attempting to operate the TV from a third-party application, for example, one of the Internet of Things (IoT) applications such as ifttt.com.
- **Disabled [Desactivado]** – Device connection is completely disabled. The TV does not accept external commands from any source, including the Roku mobile app.

## Home theater configuration

Your TV has several features that make it an ideal TV for a home theater. But you might not notice them because they remain in the background until you decide to use them.

### Turning off the TV speakers for home theater use

When you use your TV with a sound bar or an external amplifier and speakers, you'll probably want to turn off the internal TV speakers.

To turn off the TV's built-in speakers, in the Home screen menu, navigate to **Settings [Configuración] > Audio [Audio] > TV speakers [Altavoces de TV]** and change the setting.

**Tip:** *The TV's internal speakers can be enabled and disabled automatically as needed by system audio control, as described in [Enable system audio control](#). Using the headphone jack also turns off the internal speakers.*

## Setting up a digital audio connection

To take advantage of your TV's advanced audio capabilities, connect it to an external amplifier, receiver, or sound bar by using either of these two digital audio connections:

- **HDMI ARC** [*(This is a physical panel label – do not translate)*] – The HDMI® Audio Return Channel enables the TV to output digital audio on one of its HDMI® connectors. The connected amplifier can also function simultaneously as an input source to the TV, if needed. To use the ARC capability, you must connect an HDMI® cable from your amplifier's HDMI® ARC connector to the **HDMI ARC** connector on the TV. You also must:
  - Be sure your HDMI® cable is certified by HDMI®.
  - Enable **HDMI ARC [HDMI ARC]** under **Settings [Configuración] > System [Sistema] > Control other devices (CEC) [Control de otros dispositivos (CEC)]**, as explained in [Enable HDMI® ARC](#).
- **SPDIF optical** [*(This is a physical panel label – do not translate)*] – The SPDIF optical connector outputs a digital audio signal. To use the optical output, connect a TOSLINK optical cable from the amplifier to the Optical or SPDIF connector on the TV.

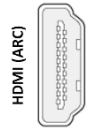

**Note:** *Dolby Audio™ supporting Dolby Digital Plus™ format is not available through the SPDIF optical output. This format is only available through the HDMI® ARC connection.*

After making the required HDMI® ARC or SPDIF optical connection, go to **Settings [Configuración] > Audio [Audio] > S/PDIF and ARC [S/PDIF y ARC]** option and select the audio format to use.

**Note:** *In most cases, **Auto detect [Detección automática]** is the best option. Other settings can result in no sound when the content you are viewing does not contain the audio stream type you selected.*

## Turning off the TV screen while listening to music

Certain music channels enable you to turn off the TV screen while streaming music to your TV speakers, sound bar, home theater receiver, or Roku wireless speakers.

To turn off the TV screen on supported channels:

1. Press **\*** to display the Options menu.
2. Press the **DOWN** arrow to highlight **Turn off display [Desactivar pantalla]**.
3. Press **OK**.

**Note:** This feature is available only on select streaming audio channels, and only when the TV is operating in connected mode with **Fast TV Start [Inicio rápido de TV]** enabled. To enable **Fast TV Start [Inicio rápido de TV]**, from the Home screen [Pantalla principal], navigate to **Settings [Configuración] > System [Sistema] > Power [Energía]**.

## Controlling other devices through CEC

Consumer Electronics Control (CEC) enables your TV and other CEC-compatible home entertainment devices to control one another in various ways. First, the CEC-compatible devices must “discover” one another and report their capabilities. After this, one device can control another according to the features you enable. For example, playing a disc on a Blu-ray™ player could switch the TV to the Blu-ray™ player’s input. Or, powering off the TV could also power off the Blu-ray™ player and the home theater receiver.

### Discover connected CEC devices

To discover CEC devices:

1. Make sure that your CEC-compatible devices are connected to the TV with a suitable High Speed HDMI® Cable that supports HDMI® ARC and CEC control.
2. Turn on each device and make sure all devices are CEC enabled.

**Tip:** *Some manufacturers have their own branded names for CEC functionality, so you might need to read the product documentation to correctly identify the CEC features of the device.*



3. On the TV's Home screen menu, navigate to **Settings [Configuración] > System [Sistema] > Control other devices (CEC) [Control de otros dispositivos (CEC)]** and then select **Search for CEC devices [Buscar dispositivos CEC]**. Press **OK** to repeat the discovery process, if necessary.

When finished, the TV displays a list of CEC devices that are connected to each HDMI® input, as well as any devices that had previously been connected. The TV remembers the names of multiple CEC devices even when they are no longer connected. If the list is longer than the allowed space, press **\*** to see a complete list in a scrollable window.

### Enable HDMI® ARC

HDMI® ARC is the audio return channel that is available on one of the TV's HDMI® ports. The audio return channel enables you to send a Dolby Audio™ signal back to a home theater receiver that is also sending an audio and video signal into the TV. Using HDMI® ARC reduces the number of cables needed and optionally lets you control the volume and mute state of the receiver by enabling system audio control.

HDMI® ARC is disabled by default. To enable HDMI® ARC, in the Home screen menu, navigate to **Settings [Configuración] > System [Sistema] > Control other devices (CEC) [Control de otros dispositivos (CEC)]**, and then highlight **HDMI ARC [HDMI ARC]**. Press **OK** to enable or disable the feature.

**Note:** *Enabling **HDMI ARC** also enables **System audio control [Control de sistema de audio]**. After enabling **HDMI ARC**, you can disable **System audio control [Control de sistema de audio]** if you prefer.*

### Enable system audio control

System audio control enables the TV remote to change the volume and mute state of an amplifier or sound bar connected through HDMI®, and to display the external device's volume and mute status in the TV's on-screen display.

The TV automatically turns off its internal speakers and sends volume and mute control signals to an external amplifier when all of the following are true:

- **System audio control [Control de sistema de audio]** is enabled on the TV.
- The TV is connected to a CEC-compatible amplifier, it is powered on, and CEC discoverability is enabled.

- The CEC-compatible amplifier's HDMI® ARC connector is connected to the TV's **HDMI ARC** connector with a suitable HDMI® cable.

When the CEC-compatible amplifier is off, the TV automatically turns on its speakers (unless you have turned them off as described in [Turning off the speakers](#)) and resumes local control of volume and mute state.

To enable or disable system audio control, in the Home screen menu, navigate to **Settings [Configuración] > System [Sistema] > Control other devices (CEC) [Control de otros dispositivos (CEC)]** and highlight **System audio control [Control de sistema de audio]**. Press **OK** to enable or disable the feature.

### Enable 1-touch play

1-touch play enables a device to control which TV input is active. For example, pressing **Play [Reproducir]** on your Blu-ray™ player switches the TV to the Blu-ray™ input.

1-touch play is disabled by default. To enable 1-touch play, in the Home screen menu, navigate to **Settings [Configuración] > System [Sistema] > Control other devices (CEC) [Control de otros dispositivos (CEC)]** and highlight **1-touch play [Reproducción con un toque]**. Press **OK** to enable or disable the feature.

### Enable system standby

The system standby feature causes other devices to power off when you power off your TV. Depending on the CEC System Standby implementation, it also might enable connected devices to power off your TV when you power off the device.

System standby is disabled by default. To enable system standby, in the Home screen menu, navigate to **Settings [Configuración] > System [Sistema] > Control other devices (CEC) [Control de otros dispositivos (CEC)]** and highlight **System standby [Sistema en espera]**. Press **OK** to enable or disable the feature.

## Restart the TV

You can restart the TV when necessary. Restarting has the same effect as unplugging the TV power and then plugging it in again.

To restart the TV, navigate to **Settings [Configuración] > System [Sistema] > Power [Energía]**, and then select **System restart [Reinicio del Sistema]**. Highlight **Restart [Reiniciar]**, and then press **OK** to confirm restart.

While the TV restarts, the screen goes dark for a few seconds, and then displays the startup screen for a few more seconds. When the restart operation completes, the TV displays the activity you selected in [Power on settings](#).

## Reset the TV

You can choose to reset only the TV picture and audio settings to their original values, or perform a full factory reset to return the TV to the state it was in when you first unpacked and turned it on.

### Reset audio/video settings

To reset only the TV picture and audio settings to their original values, navigate to **Settings [Configuración] > System [Sistema] > Advanced system settings [Configuración avanzada] > Factory reset [Restablecimiento de fábrica]**, and then highlight **Reset TV audio/picture settings [Restablecer config. de audio/imagen]**. Read the information on the screen to make sure you understand what the reset operation does.

To proceed with the reset operation, press **PLAY/PAUSE** three times in a row.

### Factory reset everything

A full factory reset returns the TV's settings to their original state and removes all personally identifiable information from the TV. When finished, you must repeat Guided Setup, reconnecting to the Internet, re-linking your Roku account, and reloading any streaming channels. You also must repeat Antenna TV setup and input configuration.

Factory reset is the recommended choice if you want to transfer the TV to another owner, and it is the only choice if you want to switch from Store mode to Home mode (if you inadvertently selected Store mode during Guided Setup).

To perform a factory reset, navigate to **Settings [Configuración] > System [Sistema] > Advanced system settings [Configuración avanzada] > Factory reset [Restablecimiento de fábrica]**, and then highlight **Factory reset everything [Restablecer config. de fábrica]**. Read the information on the screen to make sure you understand what this reset operation does.

To proceed with the full factory reset, use the on-screen number pad to enter the code displayed on the screen, and then select **OK** to proceed.

When the factory reset operation completes, the TV restarts and displays the first Guided Setup screen.

## What if I can't access the Factory Reset option?

It is possible for your TV to get into a state where you cannot access the various menus, including the menu option that lets you perform a factory reset operation. If that happens, you can force the TV to reset by following these steps.

### Models with a RESET button

1. Using a straightened paper clip or ball-point pen, press and hold the recessed RESET button on the TV connector panel.
2. Continue to hold the RESET button for approximately 12 seconds.

When the reset cycle completes, the status indicator comes on dim.

3. Release the RESET button. The TV is now powered off.
4. Turn on the TV and proceed through Guided Setup. See [Guided Setup](#).

### Models without a RESET button

1. On the TV panel (not the remote) press and hold down the MUTE and POWER buttons.
2. Unplug the TV power, and then plug it in while continuing to hold down the MUTE and POWER buttons.

3. When you see the startup screen appear on the TV, release the buttons.
4. Turn on the TV and proceed through Guided Setup. See [Guided Setup](#).

## Network connection reset

If you want to remove your network connection information without disturbing other settings, navigate from the Home screen to **Settings [Configuración] > System [Sistema] > Advanced systems settings [Configuración avanzada] > Network connection reset [Reinicio de la conexión de red]**, and then select **Reset connection [Reiniciar la conexión de red]**.

When you select this option, the TV removes your wireless network information, including the name of the connection (its SSID) and your wireless password, if any, and then it restarts. After restarting, your TV retains all of its other settings and its association with your Roku account.

After resetting your network connection, navigate from the Home screen to **Settings [Configuración] > Network [Red] > Set up connection [Configure la conexión]** to set up your network connection and enjoy all of the benefits of your connected TV.

## Roku account PIN

When you created your Roku account, you were given the opportunity to create a PIN code and to specify when it must be used. Roku lets you optionally require that users enter your PIN as an additional verification method when making purchases through the TV or adding items from the Roku Channel Store. In addition, you must have a Roku account PIN before you can enable or disable Guest Mode.

If you created a Roku account PIN and want to change it, or you don't remember your PIN, or if you didn't create a Roku account PIN and want to add one, you can easily make these changes.

On a computer, tablet, or smartphone, use your web browser to go to <https://my.roku.com> and sign in.

After signing in, the **My Account [Mi cuenta]** page appears.

1. Under **PIN preference [Preferencia de PIN]**, click **Update [Actualizar]** to open the **Choose your PIN preferences [Elegir tus preferencias de PIN]** page.
2. Skip this step if you just want to change your PIN. Otherwise, choose the option you prefer from among those listed:
  - Require a PIN to make purchases or to add any item from the Channel Store [Siempre solicitar un PIN para realizar compras y agregar artículos desde Channel Store].
  - Require a PIN to make purchases [Siempre solicitar un PIN para realizar compras].
  - Do not require a PIN to make purchases [No se requiere un PIN para usar hacer compras o agregar cualquier artículo de Channel Store].
3. If you choose either of the first two options, enter your PIN twice in the appropriate boxes.
4. Click **Save Changes [Guardar cambios]** to save your changes and return to the **My Account [Mi cuenta]** page. Note that your current setting is described under **PIN preference [Preferencia de PIN]**.

## Update the TV

If your TV is operating in connected mode, it will automatically get updates from time to time. You don't need to do anything. But if you are aware that an update is available and you don't want to wait until the TV updates itself, you can manually check for updates.

If your TV is operating in non-connected mode, you can still get updates by using a USB flash drive.

You can download an updated User Guide that matches your Roku TV software version from the Roku web site at:

[www.roku.com/support](http://www.roku.com/support)

To determine your current Roku TV software version, go to **Settings [Configuración]** > **System [Sistema]** > **About [Acerca de]** , and then press **OK** or navigate to the right.

## Checking for updates on a connected TV

If you're one of those people who has to have the latest, most up-to-date features the moment they are available, you can check for updates as often as you want.

To check for updates, navigate to **Settings [Configuración] > System [Sistema] > System update**, and then select **Check now**. The TV responds either with a message saying that your TV is up to date, or with a message saying that an update is available.

Follow the instructions on the screen to install the system update.

**Note:** *Sometimes system updates install new system software, and other times they install new features for streaming channels. Therefore, you won't always see a change in the behavior of your TV after a system update.*

## Getting updates on a non-connected TV

If your TV is not connected to the Internet, you can still get system updates by using a USB flash drive and a computer with an Internet connection.

To get a system update, navigate to **Settings [Configuración] > System [Sistema] > System update [Actualización del Sistema]**:

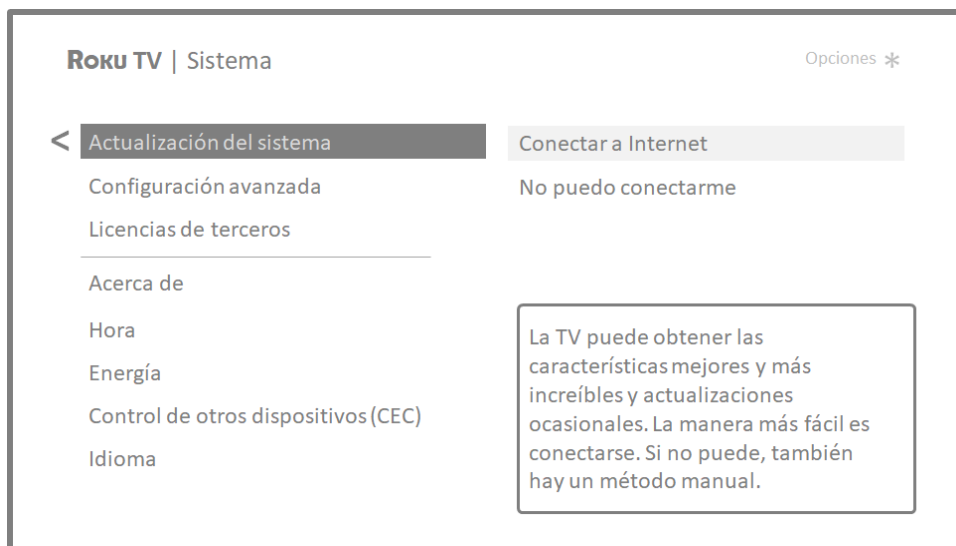

The **System update [Actualización del Sistema]** screen on a non-connected TV gives you the opportunity to connect your TV to the Internet to automatically receive updates. We recommend this option if it is possible in your situation. To proceed,

select **Connect to the Internet [Conectar a Internet]** and follow the instructions in [What if I didn't connect my TV?](#)

Otherwise, if you can't connect to the Internet, select **I can't connect [No puedo conectarme]**, and then follow the instructions on the screen. Here's a summary:

1. On an Internet-connected computer, go to the web site displayed on the **System update [Actualización del Sistema]** screen.
2. On the **USB Update [Actualización de USB]** web page, select the correct brand and model, and then click **Next [Siguiente]**.
3. Click **Download Software [Descargar software]**, and then save the file to the root folder of a standard USB flash drive.

---

### USB flash drive

Any normal USB flash drive will work, provided it has a FAT-16 or FAT-32 file system format. (This is the default for most flash drives.)

The size of the download is small—usually less than 100 MB—and so will fit on most any size flash drive you might have.

- 
4. When the download finishes, take the USB flash drive to the TV and plug it into the USB port. When you do, the TV validates the files on the flash drive and displays a 12-digit code.
  5. Write down the code and the web address, and take this information back to your Internet-connected computer.
  6. On the **12-digit code [Código de 12 dígitos]** page, enter the code your TV displayed, and then click **Next [Siguiente]**.
  7. On the **6-digit code [Código de 6 dígitos]** page, write down the 6-digit code that appears, and then take it back to your TV.



---

## 12- and 6-digit codes

The USB update process uses a pair of codes to validate that you are authorized to install an update, and to ensure you are not attempting to install an old, unsupported version of the system software.

---

8. Using the TV remote, select **Next [Siguiente]** to move to the next screen, and then use the on-screen keyboard to enter the 6-digit code. When finished, select **OK**. The system update begins. Do not remove the USB flash drive until the TV restarts.

When the update finishes, the TV restarts. You can check the new version number by navigating to **Settings [Configuración] > System [Sistema] > About [Acerca de]**.

# Other devices

## Mirror your phone or tablet

*Only in connected mode*, your TV has a feature called screen mirroring that lets you mirror your compatible smartphone or tablet on your TV. Share videos, photos, web pages, and more from compatible devices.

By default, your TV's screen mirroring mode is set to **Prompt [Indicación]**. In this mode, when your TV receives a screen mirroring request, it prompts you with the following options, unless you have previously selected **Always allow [Permitir siempre]** or **Never allow [No permitir nunca]** for the device:

- **Always allow [Permitir siempre]** – Always accept mirrored content from the mobile device without additional prompting in the future for this device.
- **Allow [Permitir]** – Accept mirrored content from the mobile device this time only. Prompt again next time this device attempts to mirror content.
- **Block [Bloquear]** – Do not accept mirrored content from the mobile device at this time. Prompt again next time this device attempts to mirror content.
- **Always block [Bloquear siempre]** – Never accept mirrored content from this mobile device.

**Note:** *You can manage and change the list of devices that are set to **Always allow** or **Never block** by navigating from the Home screen to **Settings [Configuración] > System [Sistema] > Screen mirroring [Reflejo de pantalla] > Screen mirroring devices [Dispositivos de reflejo de pantalla]**.*

- If you prefer to always allow all screen mirroring attempts without prompting, go to **Settings [Configuración] > System [Sistema] > Screen mirroring [Reflejo de pantalla]**, and then change the **Screen mirroring mode [Modo de reflejo de pantalla]** to **Always allow [Permitir siempre]**.

- If you prefer to never allow screen mirroring from any device, change the **Screen mirroring mode [Modo de reflejo de pantalla]** to **Never allow [No permitir nunca]**.

For information on which devices may work with screen mirroring and instructions on how to use it, go to the following link on the Roku web site:

[go.roku.com/screenmirroring](https://go.roku.com/screenmirroring)

## Roku mobile app

Roku makes the Roku mobile app free for compatible iOS® and Android™ mobile devices.

The Roku mobile app is an alternative remote for your Roku TV and helps you find and add new Roku Channels.

Find more information and get the Roku mobile app by using the following link to the Roku web site:

[go.roku.com/mobileapp](https://go.roku.com/mobileapp)

## Private Listening on the Roku mobile app

*Only on compatible Apple and Android devices*, the Roku mobile app enables you to use headphones connected to your device to listen to streaming programs Antenna TV channels. Make sure you have the latest version of the Roku mobile app before using this feature.

For more information, go to the following link on the Roku web site:

[go.roku.com/privatelistening](https://go.roku.com/privatelistening)

## Universal remotes

In many cases, you can program your cable or satellite universal remote to also control your TV. You will need to have instructions for programming the remote handy. Check with your cable or satellite provider for instructions.

For details on how to set up the TV to work with universal remotes, go to the following link on the Roku web site:

[go.roku.com/universalremote](https://go.roku.com/universalremote)

# FAQ

For the latest answers to Frequently Asked Questions, visit the Roku support website:

[go.roku.com/support](https://go.roku.com/support)

## Legal statement

Please note—Use of the Roku TV is governed by the Roku TV End User Agreement (see below). In addition, an end user online profile and billing account with Roku, Inc. (“Roku”) on Roku’s website (“Roku Account”) is required to stream content via the Internet using your Roku TV. A Roku Account gives you access to movies, television shows, and other audio-visual entertainment in the “Roku Channel Store,” a storefront of applications provided by Roku via your device’s on-screen menu. After your Roku Account is created, you can link your Roku TV to your account. By using the Roku TV, you agree to the following disclaimer. For the avoidance of doubt, the content disclaimer set forth herein shall refer to all content and channels accessible and available on the Roku TV, including those available via the Roku® streaming platform, as well as broadcast cable.

Due to the various capabilities of the Roku TV, as well as limitations in the available content available therein, certain features, applications, and services may not be available on all Roku TV s, or in all territories. Some features on the Roku TV may also require additional peripheral devices or membership fees that are sold separately. Please visit the Roku, Inc. website for more information on the Roku TV and content availability. The services and availability of content on the Roku TV are subject to change from time to time without prior notice.

All content and services accessible through the Roku TV belong to third parties and are protected by copyright, patent, trademark and/or other intellectual property laws. Such content and services are provided solely for your personal noncommercial use. You may not use any content or services in a manner that has not been authorized by the content owner or service provider. Without limiting the foregoing, you may not modify, copy, republish, upload, post, transmit, translate, sell, create derivative works, exploit, or distribute in any manner or medium any content or services displayed through the Roku TV.

You expressly acknowledge and agree that your use of the Roku TV is at your sole risk and that the entire risk as to satisfactory quality, performance and accuracy is with you. The Roku TV and all third party content and services are provided “as is” without warranty of any kind, either express or implied. Roku expressly disclaims all warranties and conditions with respect to the Roku TV content and services, either express or implied, including but not limited to, warranties of merchantability, of satisfactory quality, fitness for a particular purpose, of accuracy, of quiet enjoyment, and non-infringement of third party rights. Roku does not guarantee the accuracy, validity, timeliness, legality, or completeness of any content or service made available through the Roku TV and does not warrant that the Roku TV, content or services will meet your requirements, or that operation of the Roku TV will be uninterrupted or error-free. Under no circumstances, including negligence, shall Roku be liable, whether in contract or tort, for any direct, indirect, incidental, special or consequential damages, attorney fees, expenses, or any other damages arising out of, or in connection with, any information contained in, or as a result of the use of the device, or any content or service accessed by you or any third party, even if advised of the possibility of such damages.

Third party services may be changed, suspended, removed, terminated or interrupted, or access may be disabled at any time, without notice, and Roku makes no representation or warranty that any content or service will remain available for any period of time. Content and services are transmitted by third parties by means of networks and transmission facilities over which Roku has no control. Without limiting the generality of this disclaimer, Roku expressly disclaims any responsibility or liability for any change, interruption, disabling, removal of or suspension of any content or service made available through the Roku TV. Roku, the content providers, or the service providers may impose limits on the use of or access to certain services or content, in any case and without notice or liability. Any questions or requests for service relating to the content or services made available on the Roku TV should be submitted to the respective cable content or service provider or as described in the Roku TV User Guide.

In the event of a conflict between the Roku TV End User Agreement and the terms set forth in this Legal Disclaimer, the Roku TV End User Agreement shall prevail and control in all circumstances.

## ACUERDO DE LICENCIA DE USUARIO FINAL (PARA ROKU TV)

**IMPORTANTE: LEA ESTE ACUERDO DE LICENCIA DE USUARIO FINAL DETENIDAMENTE ANTES DE UTILIZAR UN ROKU TV. TAMBIÉN CONSULTE LA INFORMACIÓN IMPORTANTE DEL PRODUCTO QUE SE LE PUEDE HABER PROPORCIONADO CON SU ROKU TV.**

### Descripción general

Este Acuerdo de licencia de usuario final (“ALUF” por sus siglas en inglés) celebrado entre usted y Roku, Inc. (“Roku”) rige el uso de lo siguiente: (a) su televisor que utiliza la plataforma Roku para reproducir contenido digital a través de Internet (“Televisor”) y (b) cualquier firmware and software que haya sido preinstalado en el Televisor, así como las actualizaciones de firmware y software que Roku le proporciona para el Televisor (en su conjunto, el “Software”). Al asociar el Televisor con su cuenta en el sitio web de Roku (“Cuenta de Roku”) o utilizar el Televisor, usted acepta los términos de este ALUF. Si es residente del Espacio Económico Europeo, el hecho de aceptar el presente ALUF implica que usted renuncia expresamente a su derecho de retirarse de dicho acuerdo.

Si no acepta este ALUF, no tiene derecho a utilizar el Televisor o el Software. Si aún se encuentra dentro del período de tiempo permitido para devoluciones en virtud de la política de devolución correspondiente, usted podrá devolver el Televisor a su vendedor por un reembolso, sujeto a los términos de dicha política de devolución. Debe realizar un restablecimiento de la configuración de fábrica antes de devolverlo para borrar los datos que puedan estar

almacenados en el Televisor. Para obtener instrucciones acerca de cómo restablecer la configuración original de su Televisor, visite [www.roku.com/support](http://www.roku.com/support).

En este ALUF, “**Canal**” significa una aplicación de la Tienda del Canal Roku; “**Contenido**” significa películas, programas de televisión, música y otro tipo de entretenimiento o materiales de audio y video; “**Proveedor de contenido**” significa cualquier proveedor de Contenido; y “**Tienda del Canal Roku**” significa la tienda de aplicaciones suministradas por Roku a través del menú en pantalla del Televisor.

## Cambios al presente ALUF

Roku puede enmendar este ALUF en cualquier momento y a su criterio. Dichas enmiendas serán efectivas inmediatamente después de que se publique el ALUF enmendado en el sitio web de Roku o a través del Televisor o su Cuenta de Roku, lo que ocurra primero. Si tiene una Cuenta de Roku asociada a su Televisor, entonces Roku, a su opción, puede además notificarle acerca del ALUF enmendado mediante el envío de una notificación a la última dirección de correo electrónico que usted le haya proporcionado a Roku. Usted acuerda brindar información precisa y completa si y cuando configure su Cuenta de Roku y acuerda actualizar inmediatamente la información de su cuenta (que incluye la información de contacto) para que siga siendo precisa y completa. Puede hacer esto en cualquier momento ingresando en su Cuenta de Roku. Luego de la publicación o notificación por cualquiera de los métodos descriptos anteriormente, la continuación del uso de su Televisor o Cuenta de Roku significa que está de acuerdo con el ALUF enmendado. Si no acepta el ALUF enmendado, es posible que Roku no pueda brindarle actualizaciones, renovaciones o mejoras a su Televisor, y es posible que no pueda continuar utilizando su Televisor o la Cuenta de Roku.

## Uso permitido y restricciones

El Televisor y el Software son solamente para uso personal y no comercial. Está estrictamente prohibida la copia o redistribución de cualquier Contenido entregado a través del Televisor, y podemos prevenir o restringir la copia y redistribución de cualquier elemento del Software o del Contenido utilizando la gestión de derechos digitales u otras tecnologías. El Televisor y el Software pueden utilizarse únicamente en los países donde el fabricante de su Televisor haya autorizado su venta. Si utiliza el Televisor y el Software fuera de estos países, no aplicarán los derechos otorgados en virtud de este ALUF. Algunos de los Proveedores de contenido utilizan tecnologías para verificar su ubicación geográfica y es posible que no pueda utilizar el Televisor o el Software para acceder a cualquier Contenido fuera del país o la ubicación autorizada por Roku o el Proveedor de contenido. Salvo por lo expresamente previsto en virtud del presente ALUF, usted no adquiere ningún derecho de propiedad intelectual o de otro tipo de propiedad sobre o al Televisor, Software o Contenido, lo cual incluye cualquier derecho de patentes, invenciones, mejoras, diseños, marcas comerciales, derechos de bases de datos o derechos de autor, ni adquiere ningún derecho sobre cualquier información confidencial o secreto comercial. Roku o sus correspondientes licenciantes se reservan todos los derechos que no se le otorgan expresamente por medio del presente ALUF. No podrá eliminar, enmascarar, alterar ni ocultar las marcas comerciales, logotipos, derechos de autor u otro aviso de propiedad en o sobre el Televisor, el Software o el Contenido.

El Software es propiedad de Roku o sus terceros licenciantes y podrá ser utilizado únicamente con el Televisor. Sujeto al presente ALUF y, cuando corresponda, a las licencias de terceros correspondientes, usted posee una licencia no exclusiva e intransferible para ejecutar el Software y cualquiera de sus versiones actualizadas suministradas por Roku, únicamente en el Televisor y tal como se incorporan en este. Esto constituye una licencia y no una venta. No podrá (a) copiar, ceder, sublicenciar, alquilar, vender o rentar el Software, (b) distribuir o de otra manera transferir el Software salvo como se encuentra incorporado en el Televisor, quedando establecido que usted no conserva ninguna copia del Software y el receptor lee y acepta el presente ALUF (con sus enmiendas); (c) modificar, adaptar, traducir o crear obras derivadas del Software (salvo en la medida en que cualquiera de las restricciones mencionadas esté prohibida por la ley aplicable o en la medida en que lo permitan los términos de la licencia que rigen cualquier Código con licencia separada incluido con el Software); (d) descompilar, desensamblar, realizar ingeniería inversa o de otra manera derivar el código fuente del Software, salvo en la medida en que dichas acciones no se puedan prohibir en virtud de la ley aplicable por ser esenciales para alcanzar la interoperabilidad del Software con otro programa de software y siempre que la información que usted obtenga durante dichas actividades (i) se utilice únicamente para alcanzar dicha interoperabilidad; (ii) no sea divulgada sin el consentimiento previo por escrito de Roku; y (iii) no se utilice para crear cualquier software que sea sustancialmente similar al Software; (e) anular, evitar, eludir o interferir en los mecanismos de seguridad o las medidas de control del acceso, u (f) ordenar a un tercero que realice alguna de estas acciones. Esta licencia no incluye el derecho a recibir renovaciones o actualizaciones del Software. Su derecho a utilizar el Televisor y el Software finalizará inmediatamente ante su incumplimiento del presente ALUF.

## Actualizaciones del Software

A SU CRITERIO EXCLUSIVO, ROKU PODRÁ PROPORCIONAR ACTUALIZACIONES PARA SU TELEVISOR A TRAVÉS DE INTERNET, LO CUAL INCLUYE CORRECCIONES DE FALLOS (BUG FIXES) Y ACTUALIZACIONES, CAMBIOS EN LA INTERFAZ DE USUARIO O EN CÓMO USTED ACCEDE AL CONTENIDO Y OTROS CAMBIOS QUE PUEDEN AGREGAR, ALTERAR O ELIMINAR FUNCIONALIDADES Y CARACTERÍSTICAS. USTED ACEPTA QUE ESTAS ACTUALIZACIONES: (A) PUEDEN OCURRIR AUTOMÁTICAMENTE EN SEGUNDO PLANO EN CUALQUIER MOMENTO (Y QUE USTED NO PUEDE DESACTIVARLAS); Y (B) QUE PARA RECIBIRLAS ES NECESARIO DISPONER DE CONEXIÓN A INTERNET Y ES POSIBLE QUE INCURRA EN CARGOS DE DATOS ADICIONALES POR PARTE DEL PROVEEDOR DE LA CONEXIÓN A INTERNET. USTED COMPRENDE QUE ESTAS ACTUALIZACIONES SON NECESARIAS PARA MANTENER LA COMPATIBILIDAD CON OTRAS ACTUALIZACIONES DE PRODUCTOS O SERVICIOS DE ROKU Y QUE PUEDEN SER NECESARIAS POR MOTIVOS DE SEGURIDAD. AL UTILIZAR EL TELEVISOR, USTED ACEPTA, POR MEDIO DEL PRESENTE, RECIBIR DICHAS ACTUALIZACIONES.

## Código con licencia separada

Determinados componentes del Software se suministran con términos de licencia separada de terceros ( “**Código con licencia separada**”) y su derecho a usar dichos componentes está regido por dichos términos de licencia. Visite <https://www.roku.com/separatelylicensedcode> para obtener más información.

## Servicios de voz

Puede utilizar su voz para controlar su Televisor (p. ej. buscar contenido, cambiar de entradas, lanzar canales y lanzar Smart Guide) a través de (i) la aplicación móvil de Roku, si ha descargado la aplicación móvil de Roku en su teléfono o dispositivo móvil; o (ii) un control remoto de voz compatible si su Televisor admite servicios de voz en su país de residencia. Cuando elige usar su voz para controlar su Televisor, acepta que Roku y terceros que cumplan con sus solicitudes y/o nos brinden servicios, tengan su consentimiento para grabar, procesar y almacenar sus entradas de voz (p. ej., una grabación y la interpretación de lo que fue dicho), y usar tales entradas de voz con otra información sobre su Televisor (p. ej. identificador de dispositivo) para proporcionarle servicios, mejorar la precisión y calidad del servicio y como se describe en la Política de Privacidad de Roku. Para obtener más información sobre los servicios de voz, visite las páginas de preguntas frecuentes del sitio web de Roku en [www.roku.com/support](http://www.roku.com/support).

## EXCLUSIÓN DE GARANTÍA DE ROKU; LIMITACIÓN DE RESPONSABILIDAD

La garantía que USTED obtiene respecto del Televisor la otorga el FABRICANTE DEL TELEVISOR y no Roku. ROKU NO LE OFRECE GARANTÍA ALGUNA EN VIRTUD DE ESTE ALUF. SIN LIMITAR LA NATURALEZA GENERAL DE LA EXENCIÓN DE RESPONSABILIDAD PRECEDENTE, CON EL MÁXIMO ALCANCE PERMITIDO POR LA LEY APLICABLE:

- (A) EL CÓDIGO CON LICENCIA SEPARADA Y EL SOFTWARE SE PROPORCIONAN “COMO ESTÁN”, CON TODAS LAS FALLAS Y SIN GARANTÍA DE NINGÚN TIPO. ROKU NIEGA TODAS LAS OTRAS GARANTÍAS Y CONDICIONES, LO QUE INCLUYE LA GARANTÍA IMPLÍCITA DE COMERCIABILIDAD, CALIDAD SATISFACTORIA, ADECUACIÓN PARA UN FIN DETERMINADO Y NO INFRACCIÓN. ROKU NO MANIFIESTA NI GARANTIZA QUE EL TELEVISOR, EL CÓDIGO CON LICENCIA SEPARADA Y EL SOFTWARE CUMPLIRÁN CON LO SIGUIENTE: (I) SERÁN SEGUROS, ESTARÁN LIBRES DE VIRUS O DE ERRORES, O BIEN (II) ESTARÁN LIBRES DE ATAQUES O INTRUSIONES DE SEGURIDAD.
- (B) EN NINGÚN CASO, ROKU, SUS DIRECTORES, FUNCIONARIOS O EMPLEADOS SERÁN RESPONSABLES FRENTE A USTED POR LESIONES PERSONALES O DAÑOS A LA PROPIEDAD, O POR CUALQUIER DAÑO Y PERJUICIO ESPECIAL, INCIDENTAL, EJEMPLAR, PUNITIVO, INDIRECTO O CONSECUENTE DE NINGÚN TIPO QUE RESULTE DE CUALQUIER TELEVISOR, EL CÓDIGO CON LICENCIA SEPARADA, EL SOFTWARE O EL USO QUE HAGA DE ELLOS; Y
- (C) USTED ACEPTA QUE LA RESPONSABILIDAD TOTAL ACUMULADA DE ROKU, SUS DIRECTORES, FUNCIONARIOS Y EMPLEADOS EN VIRTUD DEL PRESENTE ALUF, QUE INCLUYE LA RESPONSABILIDAD RELACIONADA CON TODOS LOS TELEVISORES ASOCIADOS A SU CUENTA DE ROKU Y EL CÓDIGO CON LICENCIA SEPARADA Y EL SOFTWARE INSTALADO EN DICHS TELEVISORES, y el uso que haga de ellos, NO EXCEDERÁ EL MONTO ESTABLECIDO EN LOS TÉRMINOS DE LA CUENTA DE ROKU Y LAS CONDICIONES QUE USTED ACEPTÓ PARA SU CUENTA DE ROKU, Y QUE (II) ROKU, SUS DIRECTORES, FUNCIONARIOS Y EMPLEADOS NO SERÁN RESPONSABLES FRENTE A USTED EN VIRTUD DE ESTE ALUF POR LOS DAÑOS DIRECTOS QUE RESULTEN DEL TELEVISOR O SE RELACIONEN CON ÉL. LAS LIMITACIONES MENCIONADAS APLICARÁN AÚN CUANDO EL RECURSO BRINDADO EN EL PRESENTE DOCUMENTO NO CUMPLA CON SU OBJETIVO ESENCIAL Y AÚN CUANDO ROKU, SUS DIRECTORES, FUNCIONARIOS O EMPLEADOS HAYAN SIDO NOTIFICADOS ACERCA DE LA POSIBILIDAD DE DICHA RESPONSABILIDAD.

Algunas jurisdicciones no admiten exclusiones DE DETERMINADAS garantías O LIMITACIONES DE RESPONSABILIDAD PARA DETERMINADOS TIPOS DE DAÑOS Y PERJUICIOS, por lo que ES POSIBLE QUE ALGUNAS DE las LIMITACIONES MENCIONADAS ANTERIORMENTE EN ESTA SECCIÓN NO se le apliquen. NINGUNA DISPOSICIÓN EN ESTOS TÉRMINOS DE USO AFECTARÁ LOS DERECHOS ESTATUTARIOS IRRENUNCIABLES QUE SE LE APLIQUEN Y es posible que tenga otros derechos que varían de una jurisdicción a otra.

## Controles de exportación

Usted acepta no descargar Contenido o Software, ni de otra manera exportar o reexportar ningún Televisor o el Software a (o a un ciudadano o residente de) Cuba, Irak, Libia, Corea del Norte, Irán, Siria o cualquier otro país al que Estados Unidos o su país haya embargado bienes, o bien a cualquier persona incluida en la Lista de Ciudadanos Especialmente Designados del Departamento del Tesoro de Estados Unidos o la Lista de Pedidos Denegados del Departamento de Comercio de EE. UU. o en listas restringidas similares emitidas ocasionalmente por su gobierno. Al utilizar cualquier Televisor o el Software, usted manifiesta y garantiza que no está ubicado en, bajo el control de, ni es ciudadano o residente de, cualquiera de esos países ni se encuentra en esas listas.

## Legislación aplicable; resolución de conflictos

- A. Si es un consumidor y residente de un país del Espacio Económico Europeo en donde la venta del Televisor está expresamente autorizada por su fabricante, este ALUF no se aplica a usted.
- B. En el resto de los casos, incluso si usted es residente de Estados Unidos (y sus posesiones y territorios) o Canadá, acepta que el presente ALUF estará regido por las leyes del estado de California sin perjuicio de



cualquier principio relacionado con un conflicto de leyes que pueda estipular la aplicación de la ley de otra jurisdicción; y

1. Usted y Roku acuerdan estar sujetos a los procedimientos establecidos a continuación para la resolución de cualquier reclamación entre usted y Roku que surja de o esté relacionada con cualquier aspecto del presente ALUF, ya sea que se base en un contrato, agravio, estatuto, fraude, declaración falsa o cualquier teoría jurídica, lo cual incluye, sin carácter limitativo, las reclamaciones entre usted y Roku relacionadas con el Televisor y el Software. Cada una de estas reclamaciones se denomina individualmente “**Reclamación**” y en su conjunto “**Reclamaciones**”.
2. **Usted y Roku acuerdan que, salvo por LAS reclamaciones identificadas en el párrafo 4 de la siguiente sección, cualquier RECLAMACIÓN ENTRE USTED Y ROKU será, en última instancia, resuelta mediante un proceso de arbitraje vinculante.** El arbitraje tendrá lugar en el condado de Santa Clara, California, y será administrado por la Asociación Americana de Arbitraje (“AAA”) de conformidad con las normas que rijan a la AAA en ese momento, lo cual incluye (si correspondiera) los Procedimientos complementarios de la AAA para disputas relacionadas con los consumidores. Tenga en cuenta que no existen jueces ni jurados en el arbitraje. Los procedimientos de arbitraje son más simples y más limitados que las normas aplicables por un tribunal y la revisión de la decisión del árbitro por parte de un tribunal es limitada. **ASIMISMO, USTED Y ROKU ACUERDAN QUE CADA UNO PUEDE PRESENTAR UNA RECLAMACIÓN EN CONTRA DEL OTRO SOLO EN FORMA INDIVIDUAL Y NO COMO DEMANDANTE O MIEMBRO DE UNA DEMANDA COLECTIVA EN UN SUPUESTO PROCEDIMIENTO O ACCIÓN JUDICIAL COLECTIVA O DE REPRESENTACIÓN. El árbitro no podrá consolidar o unir la reclamación de más de una persona, y no podrá presidir cualquier procedimiento consolidado, de representación o colectivo. Asimismo, el árbitro puede otorgar una compensación (lo cual incluye una compensación monetaria, medida cautelar o compensación declaratoria) solo en forma individual y no puede otorgar ningún tipo de compensación consolidada, de representación o colectiva.** Sin perjuicio de cualquier declaración en contrario incluida en estos términos, si la exención de acción judicial colectiva incluida en esta disposición se considera inválida o no ejecutable, o bien si se permite que un arbitraje prosiga como acción colectiva, entonces ni usted ni Roku tendrán derecho a someter las Reclamaciones a arbitraje. Esta disposición de arbitraje está sujeta a la Ley de Arbitraje Federal. El laudo del árbitro será vinculante para usted y para Roku, y podrá presentarse ante cualquier tribunal de jurisdicción competente.
3. La información acerca de la AAA y de cómo se inicia un proceso de arbitraje puede encontrarse en [www.adr.org](http://www.adr.org) o llamando al 800-778-7879. Para Reclamaciones entre Usted y Roku de USD 75.000 o menos, usted será responsable de la tasa inicial de presentación de una disputa en un proceso de arbitraje, hasta el monto de la tasa inicial de presentación que debería pagar si iniciara una demanda legal en contra de Roku y ante un tribunal judicial en función de dichas Reclamaciones. Si el árbitro determina que dichas Reclamaciones no son infundadas, Roku pagará cualquier diferencia en dichas tasas de presentación más los honorarios del árbitro. Para las Reclamaciones entre Usted y Roku que superen los USD 75.000, si usted puede demostrar que los costos de arbitraje serán prohibitivos en comparación con los costos de litigar, Roku abonará el monto de las tasas de presentación reales y los honorarios del árbitro para el arbitraje, según el árbitro lo considere necesario, a fin de evitar que el arbitraje sea prohibitivo en cuanto a costo en comparación con el costo de litigar.
4. Este acuerdo de arbitraje no aplica a cualquier Reclamación (a) en la cual una parte intente proteger sus derechos de propiedad intelectual (como su patente, derecho de autor, marca comercial, secreto comercial o derechos morales, pero sin incluir sus derechos de privacidad o publicidad), o(b) que pueda ser presentada ante un tribunal de reclamaciones menores.
5. Si el acuerdo de arbitrar incluido en esta disposición se considerara inválido, no ejecutable o no aplicable para una Reclamación en particular entre Usted y Roku, entonces cualquier procedimiento para resolver dicha Reclamación debe presentarse exclusivamente ante un tribunal federal de jurisdicción competente en el Distrito del Norte de California o ante un tribunal estatal del condado de Santa Clara, California. Por medio del presente, usted presta su consentimiento irrevocable a la competencia y jurisdicción exclusiva de dichos tribunales.
6. **Derecho de desistimiento de 30 días:** Usted tiene el derecho de desistir del presente acuerdo de arbitraje enviando una notificación escrita de su decisión de desistimiento a la siguiente dirección: Legal Department, Roku, Inc., 150 Winchester Circle Los Gatos, California 95032, EE. UU.; quedando establecido que la fecha del sello postal en la notificación no debe superar los 30 días desde la producción de uno de los siguientes eventos, el que ocurra primero, si todavía no tiene una Cuenta de Roku: (a) la fecha de compra de su Televisor o (b) la fecha de creación de su Cuenta de Roku. Si tiene una Cuenta de Roku existente, todos los dispositivos que decida asociar a su Cuenta de Roku y todos los servicios suministrados por Roku a los que acceda mediante estos dispositivos, estarán sujetos al presente acuerdo de arbitraje. La notificación debe incluir su nombre completo, dirección postal actual, número de teléfono y dirección de correo electrónico, el nombre del producto y el número de serie de su Televisor, más una copia del comprobante original de compra de su Televisor. Si envía la notificación de forma oportuna de conformidad con el presente párrafo 6, el acuerdo de arbitraje no se aplicará a usted ni a Roku. Si no envía esta notificación de manera oportuna, entonces se considerará que se ha comprometido a regirse por el presente acuerdo de arbitraje.
7. Sin perjuicio de cualquier disposición en contrario incluida en el presente ALUF, usted acuerda que, si Roku procura borrar o modificar materialmente el acuerdo de arbitraje descrito en el presente, dicha eliminación o modificación no aplicará a ninguna Reclamación individual respecto de la cual usted haya notificado a Roku antes de dicha modificación.

## Disposiciones generales

Roku podrá transferir sus derechos y obligaciones en virtud del presente ALUF a otra organización. Usted solo podrá transferir sus derechos u obligaciones en virtud del presente ALUF a otra persona previa aceptación por escrito de Roku. Este ALUF se constituye entre usted y Roku. Ninguna otra persona tendrá derecho a hacer cumplir estos términos. Cada uno de los párrafos del presente ALUF opera de manera separada. Si cualquier tribunal o autoridad relevante decide que cualquiera de ellos es ilegal, el resto de los párrafos continuará en plena vigencia y efecto. Si Roku no le insiste en que cumpla con alguna de sus obligaciones en virtud del presente ALUF o si Roku no ejerce sus derechos en contra de usted o bien se demora en hacerlo, eso no constituirá una renuncia de Roku a sus derechos contra usted ni significará que usted no está obligado a cumplir con esas obligaciones. Si Roku lo exonera de un incumplimiento, Roku lo hará solo por escrito pero eso no constituirá una exoneración automática por parte de Roku de cualquier otro incumplimiento en el que usted pueda incurrir en el futuro.

## Información de contacto

Si desea comunicarse con Roku, envíe su correspondencia por correo a Roku, Inc., 150 Winchester Circle Los Gatos, CA 95032, EE. UU., o por correo electrónico a [customerservice@roku.com](mailto:customerservice@roku.com).

Última actualización: 20 de ago de 2018

### Dolby Audio™

Manufactured under license from Dolby Laboratories. Dolby, Dolby Audio, and the double-D symbol are trademarks of Dolby Laboratories. Copyright 1992-2015 Dolby Laboratories. All rights reserved.



### Dolby Vision™

Dolby, Dolby Vision, and the double-D symbol are trademarks of Dolby Laboratories. Manufactured under license from Dolby Laboratories. Confidential unpublished works. Copyright © 2013-2015 Dolby Laboratories. All rights reserved.



### HDMI®

The terms HDMI® and HDMI® High-Definition Multimedia Interface, and the HDMI® Logo are trademarks or registered trademarks of HDMI® Licensing LLC in the United States and other countries.



### Roku

ROKU, ROKU TV and the ROKU logo are the trademarks or registered trademarks of Roku, Inc. All other trademarks and logos herein are the property of their respective owners.



# Limited warranty

## LIMITED WARRANTY ONE (1) YEAR

PRODUCT IMPORTED AND MARKETED BY:  
P&F MEXICANA S.A.DE C.V.  
AV. JAIME BALMES NO.11, TORRE A PISO1,  
COL. POLANCO I SECCION. MIGUEL HIDALGO.  
CD DE MEXICO, MEXICO C.P. 11510

TECHNICAL ASSISTANCE:  
P&F MEXICANA S.A.DE C.V.  
AV. JAIME BALMES NO.11, TORRE A PISO1,  
COL. POLANCO I SECCION. MIGUEL HIDALGO.  
CD DE MEXICO, MEXICO C.P. 11510  
TEL: (55 ) 1328 5220

Customer Information Center:

Mexico City (55) 5887 9736

Other Cities (800) 8391 989

Hours: Monday through Saturday from 8:00 to 20:00

Email: [serviciophilips@pnfmex.com](mailto:serviciophilips@pnfmex.com)

Model \_\_\_\_\_ Serial Number \_\_\_\_\_

The warranty period for this product begins on: DAY \_\_\_\_\_ MONTH \_\_\_\_\_ YEAR \_\_\_\_\_

For repair assistance, please go to the service center closest to your home (according to the attached list of authorized service centers) if you have any questions or concerns, please call our Customer Information Center, where we will gladly assist you in everything related to:

- Service for your Philips devices.
- Product information and Philips authorized service centers.
- Assistance with setup and use of your Philips brand product.
- Information where you can buy Philips parts, components, consumables and accessories.

To make a warranty claim for this product, it is necessary to present this warranty policy (signed and sealed by place of purchase) or otherwise, present your purchase invoice.

## AUTHORIZED SERVICE CENTERS

CITY	AREA CODE	PHONE NUMBER	EMAIL
ACAPULCO, GRO	744	483-20-30	<a href="mailto:serproa@yahoo.com.mx">serproa@yahoo.com.mx</a>
AGUASCALIENTES, AGS	449	915- 81 -00	<a href="mailto:jimsags@hotmail.com">jimsags@hotmail.com</a>
CAMPECHE, CAMP	981	816 -04- 71	<a href="mailto:alex_jorge81@hotmail.com">alex_jorge81@hotmail.com</a>
PLAYA DEL CARMEN, Q ROO	894	267-27-27	<a href="mailto:servicioee@hotmail.com">servicioee@hotmail.com</a>
CD.VICTORIA, TAMPS	834	184-56-07	<a href="mailto:eeii_smiller@yahoo.com.mx">eeii_smiller@yahoo.com.mx</a>
CUERNAVACA, MOR	777	313-90-92* 313-00-49	<a href="mailto:centrodeservicio_hertz2@hotmail.com">centrodeservicio_hertz2@hotmail.com</a>
LOS MOCHIS, SIN	668	812 -05- 88	<a href="mailto:electromorelos@gmail.com">electromorelos@gmail.com</a>
CULIACAN, SIN	667	716 -51- 45	<a href="mailto:padilla_carrascoestela@hotmail.com">padilla_carrascoestela@hotmail.com</a>
GUADALAJARA, JAL	333	615-72-62 * 616-83-27	<a href="mailto:leecom1@hotmail.com">leecom1@hotmail.com</a>
HERMOSILLO, SON	662	302 85 61	<a href="mailto:mayra_s@megared.net.mx">mayra_s@megared.net.mx</a> ;
MAZATLAN, SIN	669	982 42 21	<a href="mailto:e_santel@yahoo.com.mx">e_santel@yahoo.com.mx</a>
MERIDA, YUC	999	928 59 05	<a href="mailto:aevia2_007@hotmail.com">aevia2_007@hotmail.com</a>
PACHUCA, HGO	771	153 36 99	<a href="mailto:zarateelec@gmail.com">zarateelec@gmail.com</a> ;
PUEBLA, PUE	222	248 97 74	<a href="mailto:centroelectronicopuebla@gmail.com">centroelectronicopuebla@gmail.com</a>
CDMX, ZONA ARAGON	55	94 06 34	<a href="mailto:philipservicio@hotmail.com">philipservicio@hotmail.com</a>
CDMX, ZONA NORTE	55	67-26-10-90	<a href="mailto:seguimiento1@tecdata.com.mx">seguimiento1@tecdata.com.mx</a>
CDMX, ZONA ORIENTE	55	5544 16 00	<a href="mailto:cselectromex@hotmail.com">cselectromex@hotmail.com</a> ;
CDMX, ZONA PONIENTE	55	58 12 44 12	<a href="mailto:sca.serviciotv@gmail.com">sca.serviciotv@gmail.com</a>
MONTERREY, N.L.	818	375 16 17 * 400 54 03	<a href="mailto:citlalyamatamoros@prodigy.net.mx">citlalyamatamoros@prodigy.net.mx</a> ;
OAXACA, OAX	287	875 09 04	<a href="mailto:zener10@prodigy.net.mx">zener10@prodigy.net.mx</a>
ORIZABA, VER	272	724 38 53	<a href="mailto:orizaba_electronics@yahoo.com.mx">orizaba_electronics@yahoo.com.mx</a>
VERACRUZ, VER	229	334 26 72	<a href="mailto:jvl680304@gmail.com">jvl680304@gmail.com</a>
QUERETARO, QRO	442	216 10 09	<a href="mailto:zenersaulphilips@yahoo.com.mx">zenersaulphilips@yahoo.com.mx</a>
SALTILLO, COAH	844	284 40 65	<a href="mailto:electronicadigital_07@hotmail.com">electronicadigital_07@hotmail.com</a>
MEXICALI, BC	686	561-98-08 * 561-98-18	<a href="mailto:bajaelectronics2@gmail.com">bajaelectronics2@gmail.com</a>
TOLUCA, EDO.MEX	722	207 11 26	<a href="mailto:radioytv@hotmail.com">radioytv@hotmail.com</a>
TUXTLA GUTIERREZ, CHIS	961	224 0630	<a href="mailto:supervisor1.rst@gmail.com">supervisor1.rst@gmail.com</a> ;
URUAPAN, MICH	452	524 08 38	<a href="mailto:centro_electronico_philips@yahoo.com.mx">centro_electronico_philips@yahoo.com.mx</a>

## WARRANTY POLICY

### THIS POLICY IS FREE

This device has been carefully designed and manufactured with the best materials under strict quality control, guaranteeing its proper functioning for the established time period for each device (see list at the bottom) **from the time the customer receives the product.**

**This warranty includes the repair or free replacement of any part or component that eventually fails and the labor necessary for its repair, as well as transportation expenses reasonably incurred from our service center,** which will be effective in any of our Authorized service centers in the country.

If your device requires our warranty service, go to the service center closest to your home, have any questions, please call our **CUSTOMER INFORMATION CENTER** toll free throughout the republic at **(800) 839 1989** where we will gladly indicate the authorized service center closest to your home.

P&F MEXICANA S.A. de C.V. Through its authorized service centers, will **repair and return your device to you within a period not exceeding 20 business days** from the date of entry, printed on the service order of any of our authorized service centers.

**The warranty policy covers any damage or damage possibly caused by the repair and / or transporting of the device inside our authorized service centers.**

**This policy will only be valid if it is filled out and sealed by the retailer,** in case this policy is lost, you can make a warranty claim by presenting your purchase invoice

### THIS POLICY WILL NOT BE HONORED IN THE FOLLOWING CASES:

- When the device is used in conditions other than normal.
- When the device has not been operated in accordance with the accompanying instructions for use.
- When the cause of the failure or malfunction is the result of improper repair or alteration caused by persons not authorized by P&F MEXICANA S.A. de C.V

### WARRANTY PERIODS:

12 months- TVs with and without DVD digital video player, DVD digital video disc players, BLU-RAY digital video disc players, DVD digital video disc players, home theater systems, radio recorders with and without compact disc player, video projector (except lamp), mini audio systems, modular equipment, satellite reception antennas, telephones, cordless telephones, auto stereos, electronic tablets, iPod dock and wireless speakers (Bluetooth).

6 months- Radio clocks, A.M./F.M radios, rechargeable batteries and MP3 digital audio players (internet)

90 days- Accessories, remote controls, speakers, microphones, headphones and reconstructed devices of LCD TV, DVD, Blu-ray, Audio Bars and Home Theater Systems.

## WARRANTY

### License

P&F MEXICANA S.A. de C.V. hereby offers to provide, upon request, a copy of the complete source code corresponding to the open source copyrighted code, on an "AS-IS" basis, used in this product for which such offer is requested by the respective licences. This offer is valid up to three years after the purchase of the product to anyone who receives this information. To obtain the source code, contact P&F MEXICANA S.A. de C.V. You must write to P&F MEXICANA S.A. de C.V. OSS Request, Av. Jaime Balmes # 11 Tower A Floor 1 Col. Polanco I Section, Miguel Hidalgo, CDMX, C.P. 11510. P&F MEXICANA S.A. de C.V. disclaims all warranties and representations with respect to such software and related source code, including quality, reliability, usability and accuracy, and also disclaims all express, implied, legal or otherwise, including without limitation, any implied warranties of title, non-infringement, merchantability or suitability for a particular purpose. P&F MEXICANA S.A. de C.V. is not obligated to make any correction to the source code or to the source code of the open source or to provide any support or assistance with respect to it. P&F MEXICANA S.A. from C.V. disclaims all liability arising from or related to the use of the software and / or source code.

### TO OBTAIN ASSISTANCE...

Contact the customer care center at:

CD de Mexico (55) 5887 9736  
Otras Ciudades (800) 8391 989



P&F Mexicana, S.A. de C.V.  
Av. Jaime Balmes No.11 Torre A Piso 1 Col. Polanco I Seccion,  
Miguel Hidalgo, CDMX. C.P.11510

This product has been manufactured by and is sold under the responsibility of P&F Mexicana, S.A. de C.V., and P&F Mexicana, S.A. de C.V. is the warrantor in relation to this product.

The Philips trademark and the Philips Shield Emblem are registered trademarks of Koninklijke Philips N.V. used under license.