

Register your product and get support at
www.philips.com/welcome

6200 series

User Manual

50PFT6200
55PFT6200

PHILIPS

Contents

1 TV Tour	4	
1.1 Philips Android TV	4	
1.2 Using Apps	4	
1.3 FreeviewPlus	4	
1.4 Playing Games	4	
1.5 Movies and missed programmes	4	4
1.6 Pause TV and Recordings	4	
1.7 Smartphones and Tablets	5	
1.8 Social Networks	5	
1.9 Bluetooth Connection	5	
2 Setting Up	6	
2.1 Read Safety	6	
2.2 TV Stand and Wall Mounting	6	6
2.3 Tips on Placement	6	
2.4 Power Cable	6	
2.5 Antenna Cable	6	
3 Connect your Android TV	8	
3.1 Network and Internet	8	
3.2 Google Account	11	
3.3 Philips App Gallery	11	
4 Connect Devices	13	
4.1 About Connections	13	
4.2 Receiver - Set-Top Box	15	
4.3 Home Theatre System - HTS	15	
4.4 Smartphones and Tablets	17	
4.5 Blu-ray Disc Player	17	
4.6 DVD Player	18	
4.7 Bluetooth - Speakers and Gamepads	18	18
4.8 Headphones	19	
4.9 Game Console	19	
4.10 Gamepad	19	
4.11 USB Hard Drive	20	
4.12 USB Keyboard	21	
4.13 USB Flash Drive	21	
4.14 Photo Camera	22	
4.15 Camcorder	22	
4.16 Computer	22	
5 Switching On and Off	24	
5.1 On or standby	24	
5.2 Keys on TV	24	
5.3 Sleep Timer	24	
5.4 Switch Off Timer	24	
6 Remote Control	25	
6.1 Key overview	25	
6.2 Voice search	26	
6.3 IR Sensor	27	
6.4 Batteries	27	
6.5 Cleaning	27	
7 Channels	28	
7.1 Install Channels	28	
7.2 Channel Lists	28	
7.3 Watching channels	29	
7.4 Favourite Channels	31	
7.5 Text / Teletext	32	
7.6 Interactive TV	33	
8 TV Guide	35	
8.1 What You Need	35	
8.2 TV Guide Data	35	
8.3 Using the TV Guide	35	
9 Recording and Pause TV	37	
9.1 Recording	37	
9.2 Pause TV	38	
10 Top Picks	40	
10.1 About Top Picks	40	
10.2 Now on TV	40	
10.3 TV on Demand	40	
10.4 Video on Demand	41	
11 Home Menu	42	
11.1 About the Home Menu	42	
11.2 Open the Home Menu	42	
11.3 Search and Voice Search	42	42
11.4 Restricted Profile	42	
12 TV Menu	43	
12.1 About TV Menu	43	
12.2 Open TV Menu	43	
13 Netflix	44	
14 FreeviewPlus	45	
15 Sources	46	
15.1 Switch to a device	46	
15.2 Options for a TV Input	46	
15.3 Device Name and Type	46	
15.4 Game or Computer	46	
15.5 Rescan Connections	47	
16 Apps	48	
16.1 About Apps	48	
16.2 Google Play	48	
16.3 App Gallery	49	
16.4 Start or Stop an App	49	49
16.5 Lock Apps	49	
16.6 Manage Apps	51	
16.7 Storage	51	
17 Games	52	
17.1 What You Need	52	
17.2 Gamepads	52	
17.3 Play a Game	52	
18 Internet	53	
18.1 Start Internet	53	
18.2 Options on Internet	53	
19 Videos, Photos and Music	54	
19.1 From a USB Connection	54	
19.2 From a Computer or NAS	54	
19.3 From a Cloud Storage Service	54	54
19.4 Play your Videos	54	
19.5 View your Photos	55	
19.6 Play your Music	55	
20 Smartphones and Tablets	57	
20.1 Philips TV Remote App	57	
20.2 Google Cast	57	
20.3 Miracast	57	
20.4 AirPlay	58	
20.5 MHL	58	
21 Multi View	60	
21.1 About Multi View	60	

21.2	Text and TV	60	
21.3	Nettv and TV	60	
21.4	HDMI and TV	60	
22	Settings	61	
22.1	Picture	61	
22.2	Sound	64	
22.3	Eco Settings	67	
22.4	General Settings	68	
22.5	Clock, Region and Language	70	
22.6	Universal Access	73	
23	Wireless and Networks	75	
23.1	Network	75	
23.2	Bluetooth	75	
24	Android Settings	76	
25	Channel Installation	77	
25.1	Antenna/Cable Installation	77	
25.2	Channel List Copy	79	
26	Software	81	
26.1	Update Software	81	
26.2	Software Version	81	
26.3	Open Source Software	81	
26.4	Open Source License	81	
26.5	Announcements	114	
27	Specifications	116	
27.1	Environmental	116	
27.2	Power	116	
27.3	Operating System	116	
27.4	Reception	116	
27.5	Display Type	116	
27.6	Display Input Resolution	116	
27.7	Dimensions and Weights	117	
27.8	Connectivity	117	
27.9	Multimedia	117	
28	Help and Support	118	
28.1	Register your TV	118	
28.2	Using Help	118	
28.3	Troubleshooting	118	
28.4	Online Help	120	
28.5	Support and Repair	120	
29	Safety and Care	121	
29.1	Safety	121	
29.2	Screen Care	122	
30	Terms of Use	123	
30.1	Terms of Use - TV	123	
30.2	Terms of Use - Smart TV	123	
30.3	Terms of Use - Philips App Gallery	123	
31	Copyrights	124	
31.1	MHL	124	
31.2	HDMI	124	
31.3	Dolby Digital Plus	124	
31.4	DTS Premium Sound™	124	
31.5	Microsoft	124	
31.6	Wi-Fi Alliance	124	
31.7	Kensington	125	
31.8	Other Trademarks	125	
Index		126	

TV Tour

1.1

Philips Android TV

This is a Philips Android TV™.

Android TV offers thousands of movies, shows and games from Google Play, YouTube and your favourite apps.*

Voice search and personalised recommendations mean more time being entertained and less time hunting for something good. With Google Cast built in, you can easily cast movies, shows and photos from your Chromebook or Android device to your TV.**

With the **Philips TV Remote App** on your smartphone or tablet, you have your TV channels at your fingertips. Send a photo to the large TV screen or follow your favourite cooking show on your tablet in the kitchen. From now on your TV is part of your mobile household.

Connect the TV to your home network and the Internet.

* The TV must be connected to the Internet. Subscriptions might be required for certain content providers.

** Casting optimized for selected services only. Streaming quality for other content might vary. Supported operating systems and devices: Android 2.3 and higher, iOS® 7 and higher, Windows® 7 and higher, Mac OS® 10.7 and higher and Chrome OS (version 38 or higher).

Google, Android, Google Play and other marks are trademarks of Google Inc. The Android robot is reproduced or modified from work created and shared by Google and used according to terms described in the Creative Commons 3.0 Attribution License.

<http://creativecommons.org/licenses/by/3.0/legalcode>

1.2

Using Apps

To get you started, some practical **Apps** are pre-installed on your TV.

The Apps pages show the collection of Apps (Applications) on your TV. Like Apps on your smartphone or tablet, the Apps on your TV offer specific functions for an enriched TV experience. Apps like TV games or weather forecasts (a.o.). Or start an Internet Browser App, like Google Chrome, to surf the Internet.

For more information, in **Help**, press the colour key **— Keywords** and look up **Apps**.

1.3

FreeviewPlus

This TV is certified by FreeviewPlus.

FreeviewPlus* provides access to content and services from the Freeview networks. The FreeviewPlus service provides a 7+ day Electronic Program Guide, all available Catch Up TV on the TV, recommendations and the ability to set reminders and favourites. FreeviewPlus is available by pressing the Green button on the remote control.

*FreeviewPlus uses HbbTV technology which combines broadcast and broadband. Internet connection is required. Data usage charges and conditions apply.

1.4

Playing Games

This TV is your big screen for **gaming**. Big enough for two.

You can play a game from a connected Game Console, a game from an installed App or simply an online game on a website. You can set the TV to the ideal settings for gaming, to allow quick and responsive action. If you play a multi-player game with split screens, you can set the TV to show each screen as a full screen simultaneously. Each player can focus on his own game to play.

1.5

Movies and missed programmes

To get a **rental video**, you don't need to leave the house.

Open **Video on Demand** and get that latest movie streamed to your TV directly. Open the video store App, create your personal account, select the movie and press play.

Video on Demand is available in selected countries.

For more information, in **Help**, press the colour key **— Keywords** and look up **Video on Demand**.

1.6

Pause TV and Recordings

If you connect a **USB Hard Drive**, you can pause and record a broadcast from a digital TV channel.

Pause your TV and answer that urgent phone call or simply take a break during a sports match, while the TV stores the broadcast on the USB Hard Drive. You can watch it again later.

With a USB Hard Drive connected, you can also record digital broadcasts. You can record while you are watching a programme or schedule a recording of an upcoming programme.

For more information, in **Help**, press the colour key **— Keywords** and look up **Pause TV** or **Recording**.

1.7

Smartphones and Tablets

The new **Philips TV Remote App** is your new TV buddy.

With the TV Remote App on your smartphone or tablet, you master your media around you. Send photos, music or videos to your big TV screen or watch any of your TV channels live on your tablet or phone. Open the TV Guide and schedule a recording for tomorrow. Your TV at home will do the job. With the TV Remote App you are in control. You might consider to simply lower the TV volume.

Download the Philips TV Remote App from your favourite app store today.

It's free.

The Philips TV Remote App is available for iOS and Android.

1.8

Social Networks

No need to get up to check your friend's messages on your computer.

On this TV you get the messages from your **social network** on your TV screen. You can send a return message from your couch.

For more information, in **Help**, press the colour key **— Keywords** and look up **Apps**.

1.9

Bluetooth Connection

Your TV has **Bluetooth** technology inside.

You can connect extra wireless speakers or a wireless headphone. Forget connecting cables, pairing your device with the TV is enough.

For more information, in **Help**, press the colour key **— Keywords** and look up **Bluetooth** or **Wireless Speakers**.

Setting Up

2.1

Read Safety

Read the safety instructions first before you use the TV.

To read the instructions, in **Help**, press the colour key **— Keywords** and look up **Safety Instructions**.

2.2

TV Stand and Wall Mounting

TV Stand

You can find the instructions for mounting the TV stand in the Quick Start Guide that came with the TV. In case you lost this guide, you can download it from www.philips.com.

Use the product type number of the TV to look for the **Quick Start Guide** to download.

Wall Mounting

Your TV is also prepared for a VESA-compliant wall mount bracket (sold separately).

Use the following VESA code when purchasing the wall mount . . .

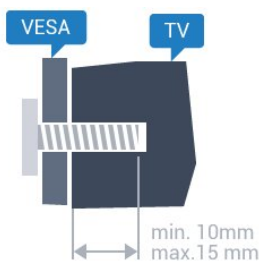

- VESA MIS-F 400x200, M6

Preparation

First remove the 4 plastic screw caps out of the threaded bushes on the back of the TV. Make sure that the metal screws, to mount the TV to the VESA-compliant bracket, go about 10mm deep inside the threaded bushes of the TV.

Caution

Wall mounting the TV requires special skills and should only be performed by qualified personnel. The TV wall mounting should meet safety standards according to the TV's weight. Also read the safety precautions before positioning the TV. TP Vision Europe B.V. bears no responsibility for

improper mounting or any mounting that results in accident or injury.

2.3

Tips on Placement

- Position the TV where light does not shine directly on the screen.
- Position the TV up to 15 cm away from the wall.
- The ideal distance to watch TV is 3 times its diagonal screen size. When seated, your eyes should be level with the centre of the screen.

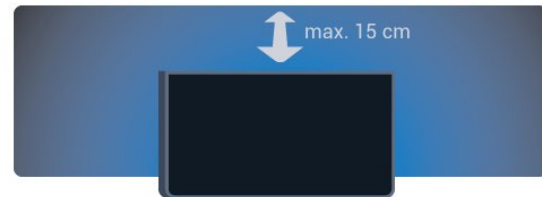

2.4

Power Cable

- Insert the power cable into the **POWER** connector on the back of the TV.
- Make sure the power cable is securely inserted in the connector.
- Make sure that the power plug, in the wall socket, is accessible at all times.
- When you unplug the power cable, always pull the plug, never pull the cable.

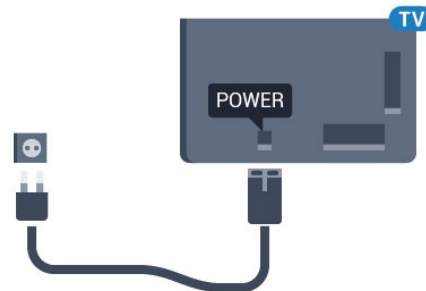

Although this TV has a very low standby power consumption, unplug the power cable to save energy if you do not use the TV for a long period of time.

For more information, in **Help**, press the colour key **— Keywords** and look up **Switching On** for more information on switching the TV on or off.

Antenna Cable

Insert the antenna plug firmly into the **Antenna** socket at the back of the TV.

You can connect your own antenna or an antenna signal from an antenna distribution system. Use an IEC Coax 75 Ohm RF antenna connector.

Use this antenna connection for DVB-T and DVB-C input signals.

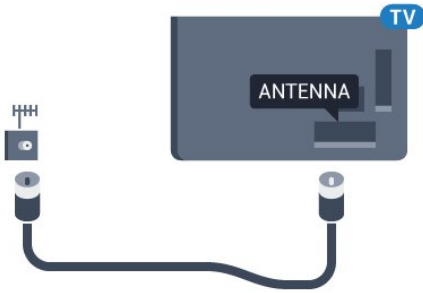

Connect your Android TV

Network and Internet

Home Network

To enjoy the full capabilities of your Philips Android TV, your TV must be connected to the Internet.

Connect the TV to a home network with a high-speed Internet connection. You can connect your TV wirelessly or wired to your network router.

Connect to Network

Wireless Connection

What You Need

To connect the TV to the Internet wirelessly, you need a Wi-Fi router with a connection to the Internet.

Use a high-speed (broadband) connection to the Internet.



Make the Connection

Wireless

To make a wireless connection...

- 1 - Press **⚙**, select **All Settings** and press **OK**.
- 2 - Select **Wireless and Networks** and press **➤** (right) to enter the menu.
- 3 - Select **Wired or Wi-Fi > Connect to Network** and press **OK**.
- 4 - Select **Wireless** and press **OK**.
- 5 - In the list of found networks, select on your wireless network. If your network is not in the list because the network name is hidden (you switched off the SSID broadcast of the router), select **Add New Network** to enter the network name yourself.

- 6 - Depending on the type of router, enter your encryption key - WEP, WPA or WPA2. If you entered the encryption key for this network before, you can select **OK** to make the connection immediately.
- 7 - A message will be shown when the connection is successful.

WPS

If your router has WPS, you can directly connect to the router without scanning for networks. If you have devices in your wireless network that use the WEP security encryption system, you cannot use WPS.

- 1 - Press **⚙**, select **All Settings** and press **OK**.
- 2 - Select **Wireless and Networks** and press **➤** (right) to enter the menu.
- 3 - Select **Wired or Wi-Fi > Connect to Network** and press **OK**.
- 4 - Select **WPS** then press **OK**.
- 5 - Go to the router, press the WPS button and return to the TV within 2 minutes.
- 6 - Select **Connect** to make the connection.
- 7 - A message will be shown when the connection is successful.

WPS with PIN Code

If your router has WPS with a PIN code, you can directly connect to the router without scanning for networks. If you have devices in your wireless network that use the WEP security encryption system, you cannot use WPS.

- 1 - Press **⚙**, select **All Settings** and press **OK**.
- 2 - Select **Wireless and Networks** and press **➤** (right) to enter the menu.
- 3 - Select **Wired or Wi-Fi > Connect to Network** and press **OK**.
- 4 - Select **WPS with PIN code** and press **OK**.
- 5 - Write down the 8-digit PIN code shown on screen and enter it in the router software on your PC. Consult the router manual on where to enter the PIN code in the router software.
- 6 - Select **Connect** to make the connection.
- 7 - A message will be shown when the connection is successful.

Problems

Wireless network not found or distorted

- Microwave ovens, DECT phones or other Wi-Fi 802.11b/g/n devices in your proximity might disturb the wireless network.
- Make sure that the firewalls in your network allow access to the TV's wireless connection.
- If the wireless network does not work properly in your home, try the wired network installation.

Internet does not work

· If the connection to the router is OK, check the router connection to the Internet.

The PC and Internet connection are slow

· Look in your wireless router's user manual for information on indoor range, transfer rate and other factors of signal quality.
· Use a high-speed (broadband) Internet connection for your router.

DHCP

· If the connection fails, you can check the DHCP (Dynamic Host Configuration Protocol) setting of the router. DHCP should be switched on.

Wired Connection

What You Need

To connect the TV to the Internet, you need a network router with a connection to the Internet. Use a high-speed (broadband) connection to the Internet.

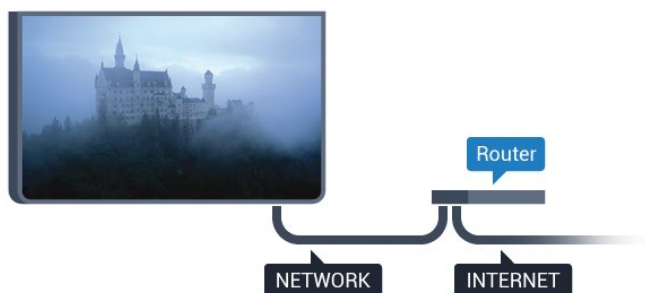

Make the Connection

To make a wired connection...

- 1 - Connect the router to the TV with a network cable (Ethernet cable**).
- 2 - Make sure that the router is switched on.
- 3 - Press **⚙️**, select **All Settings** and press **OK**.
- 4 - Select **Wireless and Networks** and press **➤** (right) to enter the menu.
- 5 - Select **Wired or Wi-Fi > Connect to Network** and press **OK**.
- 6 - Select **Wired** and press **OK**. The TV constantly searches for the network connection.
- 7 - A message will be shown when the connection is successful.

If the connection fails, you can check the DHCP setting of the router. DHCP should be switched on.

**To fulfill EMC regulations, use a shielded FTP Cat. 5E Ethernet cable.

Network Settings

View Network Settings

You can view all current network settings here. The IP and MAC address, signal strength, speed, encryption method, etc.

To view the current network settings...

- 1 - Press **⚙️**, select **All Settings** and press **OK**.
- 2 - Select **Wireless and Networks** and press **➤** (right) to enter the menu.
- 3 - Select **Wired or Wi-Fi > View Network Settings** and press **OK**.
- 4 - Press **◀** (left) repeatedly if necessary, to close the menu.

Network Configuration

If you are an advanced user and want to install your network with Static IP addressing, set the TV to **Static IP**.

To set the TV to Static IP...

- 1 - Press **⚙️**, select **All Settings** and press **OK**.
- 2 - Select **Wireless and Networks** and press **➤** (right) to enter the menu.
- 3 - Select **Wired or Wi-Fi > Network Configuration** and press **OK**.
- 4 - Select **Static IP** and press **OK** to enable **Static IP Configuration**.
- 5 - Select **Static IP Configuration** and configure the connection.
- 6 - You can set the number for **IP Address**, **Netmask**, **Gateway**, **DNS 1**, or **DNS 2**.
- 7 - Press **◀** (left) repeatedly if necessary, to close the menu.

Switch On with Wi-Fi (WoWLAN)

You can switch this TV on from your smartphone or tablet if the TV is in Standby. The setting **Switch On with Wi-Fi (WoWLAN)** must be switched on.

To switch on WoWLAN...

- 1 - Press **⚙️**, select **All Settings** and press **OK**.
- 2 - Select **Wireless and Networks** and press **➤** (right) to enter the menu.
- 3 - Select **Wired or Wi-Fi > Switch On with Wi-Fi (WoWLAN)** and press **OK**.
- 4 - Select **On** and press **OK**.
- 5 - Press **◀** (left) repeatedly if necessary, to close the menu.

Switch on Wi-Fi connection

You can switch on or off Wi-Fi connection on your TV.

To switch on Wi-Fi...

- 1 - Press , select **All Settings** and press **OK**.
- 2 - Select **Wireless and Networks** and press **➤** (right) to enter the menu.
- 3 - Select **Wired or Wi-Fi > Wi-Fi On/Off** and press **OK**.
- 4 - Select **On** and press **OK**.
- 5 - Press **◀** (left) repeatedly if necessary, to close the menu.

Digital Media Renderer - DMR

If your media files do not play on your TV, make sure that the Digital Media Renderer is switched on. As a factory setting, DMR is switched on.

To switch on DMR...

- 1 - Press , select **All Settings** and press **OK**.
- 2 - Select **Wireless and Networks** and press **➤** (right) to enter the menu.
- 3 - Select **Wired or Wi-Fi > Digital Media Renderer - DMR** and press **OK**.
- 4 - Select **On** and press **OK**.
- 5 - Press **◀** (left) repeatedly if necessary, to close the menu.

Switch on Wi-Fi Miracast

Switch on Wi-Fi Miracast to share the screen of your smartphone, tablet or computer on the TV.

To switch on Miracast...

- 1 - Press , select **All Settings** and press **OK**.
- 2 - Select **Wireless and Networks** and press **➤** (right) to enter the menu.
- 3 - Select **Wired or Wi-Fi > Wi-Fi Miracast** and press **OK**.
- 4 - Select **On** and press **OK**.
- 5 - Press **◀** (left) repeatedly if necessary, to close the menu.

For more information, in **Help**, press the colour key  **Keywords** and look up **Miracast™**, switch on.

Clear Wi-Fi Miracast connection

Clear the list of connected and blocked devices that are used with Miracast.

To clear Miracast connections...

- 1 - Press , select **All Settings** and press **OK**.
- 2 - Select **Wireless and Networks** and

press **➤** (right) to enter the menu.

3 - Select **Wired or Wi-Fi > Wi-Fi Miracast Connections** and press **OK**.

4 - Select **Clear All** and press **OK**.

5 - Press **◀** (left) repeatedly if necessary, to close the menu.

Wi-Fi Smart Screen

To watch digital TV channels on your smartphone or tablet with the Philips TV Remote App, you must switch on Wi-Fi Smart Screen. Some scrambled channels might not be available on your mobile device.

To switch on Wi-Fi Smart Screen...

- 1 - Press , select **All Settings** and press **OK**.
- 2 - Select **Wireless and Networks** and press **➤** (right) to enter the menu.
- 3 - Select **Wired or Wi-Fi > Wi-Fi Smart Screen** and press **OK**.
- 4 - Select **On** and press **OK**.
- 5 - Press **◀** (left) repeatedly if necessary, to close the menu.

TV Network Name

If you have more than one TV in your home network, you can give the TV a unique name.

To change the TV name...

- 1 - Press , select **All Settings** and press **OK**.
- 2 - Select **Wireless and Networks** and press **➤** (right) to enter the menu.
- 3 - Select **Wired or Wi-Fi > TV Network Name** and press **OK**.
- 4 - Enter the name with the on-screen keyboard or the remote control keyboard (if available).
- 5 - Select **✓** to confirm the change.
- 6 - Press **◀** (left) repeatedly if necessary, to close the menu.

Clear Internet Memory

With **Clear Internet Memory**, you can clear all Internet files and logins stored on your TV, such as passwords, cookies, and history.

To clear the Internet memory...

- 1 - Press , select **All Settings** and press **OK**.
- 2 - Select **Wireless and Networks** and press **➤** (right) to enter the menu.
- 3 - Select **Wired or Wi-Fi > Clear Internet Memory** and press **OK**.
- 4 - Select **OK** to confirm.
- 5 - Press **◀** (left) repeatedly if necessary, to close the menu.

File Sharing

The TV can connect to other devices in your wireless network, like your computer or smartphone. You can use a computer with Microsoft Windows or Apple OS X.

On this TV, you can open photos, music and videos stored on your computer.

3.2

Google Account

Sign In

To enjoy the full capabilities of your Philips Android TV, you can sign in to Google with your Google Account.

By signing in you'll be able to play your favourite games across phone, tablet and TV. You'll also get customised video and music recommendations on your TV home screen as well as access to YouTube, Google Play and other apps.

Sign In

Use your existing **Google Account** to sign in to Google on your TV. A Google Account consists of an email address and a password. If you don't have an Google Account yet, use your computer or tablet to create one (accounts.google.com). To play games with Google Play, you need a Google+ profile. If you did not sign in during the first TV installation, you can always sign in later.

To sign in after you did the TV installation...

- 1 - Press **⚙️**, select **All Settings** and press **OK**.
- 2 - Select **Android Settings** and press **OK**.
- 3 - Press **▼** (down) and select **Personal > Add account** and press **OK**.
- 4 - Press **OK** on **SIGN IN**.
- 5 - With the remote control keyboard, enter your email address and press the small **OK** key at the right of the keyboard.
- 6 - Enter your password and press the same small **OK** key to sign in.
- 7 - Press **◀** (left) repeatedly if necessary, to close the menu.

If you want to sign in with another Google Account, first sign out and sign in with the other account.

Android Settings

You can set or view several Android specific settings or information. You can find the list of apps installed on your TV and the storage space they need. You can set the language you like to use with Voice Search. You can configure the onscreen keyboard or allow apps to use your location. Explore the different Android settings. You can go to www.support.google.com/androidtv for more information on these settings.

To open these settings...

- 1 - Press **⚙️**, select **All Settings** and press **OK**.
- 2 - Select **Android Settings**, and press **OK**.
- 3 - Explore the different Android settings.
- 4 - Press **◀** **BACK** if necessary, to close the menu.

3.3

Philips App Gallery

Philips Apps

Connect the TV to the Internet to enjoy apps selected by Philips. These apps are made specially for TV. The **Philips App Gallery** offers a wide diversity of apps. For some countries, you can install apps of a local Videostore or apps from TV broadcasters in your country. The latter can offer Catch-Up TV services.

The Philips App Gallery collection of apps can differ per country or region.

Some App Gallery apps are pre-installed on your TV. To install other apps from the App Gallery, you will be asked to agree to the Terms of Use. You can set the Privacy Settings according to your preference.

Terms of Use

To install and use the Philips App Gallery apps, you must agree to the Terms of Use. If you did not agree to these terms during the first TV installation, you can always agree to them later. The moment you agree to the Terms of Use, some apps will be available immediately and you can browse the Philips App Gallery to install other apps.

To agree on the Terms of Use after you did the TV installation...

- 1 - Press **🏠** **HOME** and select **Philips Collection > App Gallery** and press **OK** to open the App Gallery.
- 2 - You can select **Terms of Use**, then press **OK** to read.
- 3 - Select **Accept** and press **OK**. You cannot undo this approval.
- 4 - Press **◀** **BACK** to close the menu.

Privacy Settings

You can set some privacy settings for the Philips App Gallery apps.

- You can allow technical statistics to be send to Philips.
- You can allow personal recommendations.
- You can allow cookies.
- You can switch on the Child Lock for 18+ rated apps.

To set the Philips App Gallery privacy settings...

1 - Press  HOME and select **Philips Collection** > **App Gallery** and press **OK** to open the App Gallery.

2 - You can select **Privacy Policy**, then press **OK** to read.

3 - Select **Accept** and press **OK**. You cannot undo this approval.

4 - Press  BACK to close the menu.

Connect Devices

About Connections

Connectivity Guide

Always connect a device to the TV with the highest quality connection available. Also, use good quality cables to ensure a good transfer of picture and sound.

When you connect a device, the TV recognizes its type and gives each device a correct type name. You can change the type name if you wish. If a correct type name for a device is set, the TV automatically switches to the ideal TV settings when you switch to this device in the Sources menu.

If you need help to connect several devices to the TV, you can visit the Philips TV connectivity guide. The guide offers information on how to connect and which cables to use.

Go to www.connectivityguide.philips.com

Antenna port

If you have a Set-top box (a digital receiver) or Recorder, connect the antenna cables to run the antenna signal through the Set-top box and/or Recorder first before it enters the TV. In this way, the antenna and the Set-top box can send possible additional channels to the Recorder to record.

HDMI ports

HDMI Quality

An HDMI connection has the best picture and sound quality. One HDMI cable combines video and audio signals. Use an HDMI cable for TV signal.

For best signal quality transfer, use a High speed HDMI cable and do not use an HDMI cable longer than 5 m.

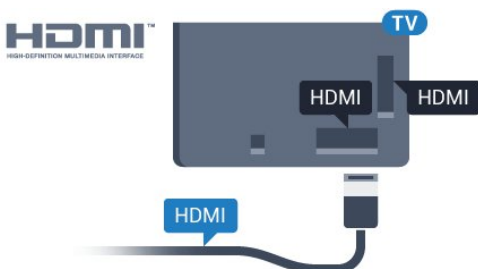

Copy protection

HDMI cables support HDCP (High-bandwidth Digital Content Protection). HDCP is a copy protection signal that prevents copying content from a DVD disc or Blu-ray Disc. Also referred to as DRM (Digital Rights Management).

HDMI ARC

All of the HDMI connections on the TV have **HDMI ARC** (Audio Return Channel).

If the device, typically a Home Theatre System (HTS), also has the HDMI ARC connection, connect it to any of the HDMI connections on this TV. With the HDMI ARC connection, you do not need to connect the extra audio cable that sends the sound of the TV picture to the HTS. The HDMI ARC connection combines both signals.

You can use any HDMI connection on this TV to connect the HTS but ARC is only available for 1 device/connection at a time.

HDMI MHL

With **HDMI MHL**, you can send what you see on your Android smartphone or tablet to a TV screen.

The **HDMI 4** connection on this TV incorporates **MHL 2.0** (Mobile High-Definition Link).

This wired connection offers great stability and bandwidth, low latency, no wireless interference and good quality sound reproduction. On top of that, the MHL connection will charge the battery of your smartphone or tablet. Although connected, your mobile device will not be charging when the TV is on standby.

Inform yourself about what passive MHL cable is suited for your mobile device. In particular, with the HDMI connector for the TV on one side, the type of connector you need to connect to your smartphone or tablet.

MHL, Mobile High-Definition Link and the MHL Logo are trademarks or registered trademarks of the MHL, LLC.

HDMI CEC - EasyLink

EasyLink

An HDMI connection has the best picture and sound quality. One HDMI cable combines video and audio signals. Use an HDMI cable for High Definition (HD) TV signals. For best signal quality transfer, use a High speed HDMI cable and do not use an HDMI cable longer than 5 m.

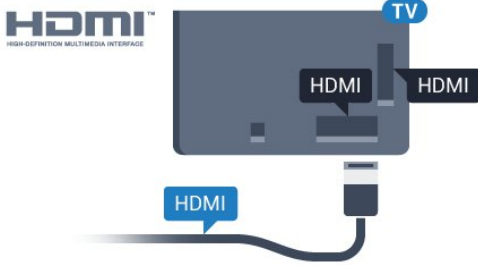

EasyLink HDMI CEC

If your devices are connected with HDMI and have EasyLink, you can operate them with the TV remote control. EasyLink HDMI CEC must be switched On on the TV and the connected device.

With EasyLink you can operate a connected device with the TV remote control. EasyLink uses HDMI CEC (Consumer Electronics Control) to communicate with the connected devices. Devices must support HDMI CEC and must be connected with an HDMI connection.

EasyLink setup

The TV comes with EasyLink switched on. Make sure that all HDMI CEC settings are properly set up on the connected EasyLink devices. EasyLink might not work with devices from other brands.

HDMI CEC on other brands

The HDMI CEC functionality has different names on different brands. Some examples are: Anynet, Aquos Link, Bravia Theatre Sync, Kuro Link, Simplink and Viera Link. Not all brands are fully compatible with EasyLink.

Example HDMI CEC branding names are property of their respective owners.

Operate Devices

To operate a device connected to HDMI and set up with EasyLink, select the device or its activity in the list of TV connections. Press **SOURCES**, select a device connected to an HDMI connection and press **OK**.

Once the device is selected, the TV remote control can control the device. However the keys **HOME** and **OPTIONS** and some other TV keys, are not forwarded to the device.

If the key you need is not on the TV remote control, you can select the key in the Options menu.

Press **OPTIONS** and select **Controls** in the menu bar. On the screen, select the device key you need and press **OK**.

Some very specific device keys might not be available in the Controls menu.

Only devices that support **EasyLink Remote Control** function will respond to the TV remote

control.

EasyLink On or Off

You can switch EasyLink on or off. The TV comes with the EasyLink settings switched on.

To switch off EasyLink completely...

- 1 - Press **Settings**, select **All Settings** and press **OK**.
- 2 - Select **General Settings** and press **Right** to enter the menu.
- 3 - Select **EasyLink**, press **Right** and select **EasyLink** one step further.
- 4 - Select **Off**.
- 5 - Press **Left** repeatedly if necessary, to close the menu.

EasyLink Remote Control

If you want devices to communicate but you don't want to operate them with the TV remote control, you can switch off EasyLink Remote Control separately.

To switch EasyLink Remote Control on or off...

- 1 - Press **Settings**, select **All Settings** and press **OK**.
- 2 - Select **General Settings** and press **Right** to enter the menu.
- 3 - Select **EasyLink > EasyLink Remote Control** and press **OK**.
- 4 - Select **On** or **Off** and press **OK**.
- 5 - Press **Left** repeatedly if necessary, to close the menu.

DVI to HDMI

If you still own a device that only has a DVI connection, you can connect the device to any of the **HDMI** connection with a DVI to HDMI adapter.

Use a DVI to HDMI adapter if your device only has a DVI connection. Use one of the HDMI connections and add an Audio L/R cable (mini-jack 3.5mm) to Audio In for sound, on the back of the TV.

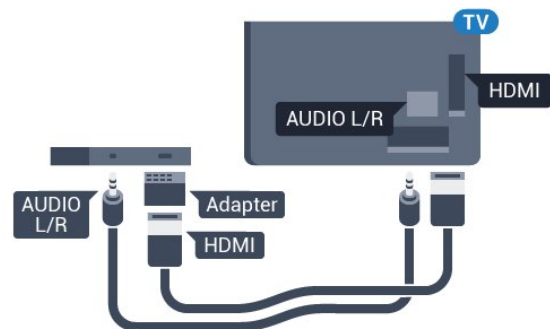

Copy protection

DVI and HDMI cables support HDCP (High-bandwidth Digital Content Protection). HDCP is a copy protection signal that prevents copying content from a DVD disc or Blu-ray Disc. Also referred to as DRM (Digital Rights Management).

Y Pb Pr – Component

Y Pb Pr – Component Video is a high quality connection.

The YPbPr connection can be used for High Definition (HD) TV signals. Next to the Y, Pb and Pr signals add the Audio Left and Right signals for sound.

Match the YPbPr (green, blue, red) connector colours with the cable plugs when you connect.

Use an Audio L/R cinch cable if your device also has sound.

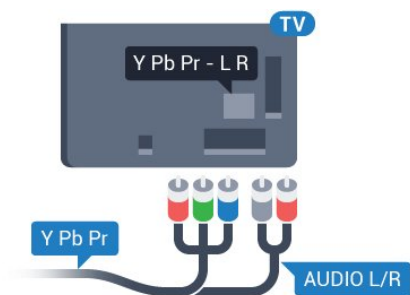

Audio Out – Optical

Audio Out – Optical is a high quality sound connection.

This optical connection can carry 5.1 audio channels. If your device, typically a Home Theatre System (HTS), has no HDMI ARC connection, you can use this connection with the Audio In – Optical connection on the HTS. The Audio Out – Optical connection sends the sound from the TV to the HTS.

You can set the type of the audio out signal to fit the audio capabilities of your Home Theatre System. For more information, in **Help**, press the colour key **— Keywords** and look up **Audio Out Settings**.

If the sound does not match the video on screen, you can adjust the audio to video synchronisation. For more information, in **Help**, press the colour key **— Keywords** and look up **Audio to Video Sync**.

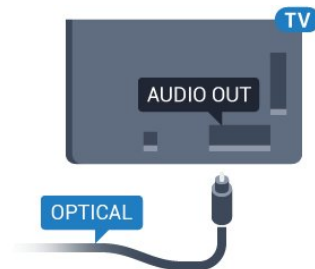

4.2

Receiver – Set-Top Box

Cable Box

Use 2 antenna cables to connect the antenna to the Set-top box (a digital receiver) and the TV.

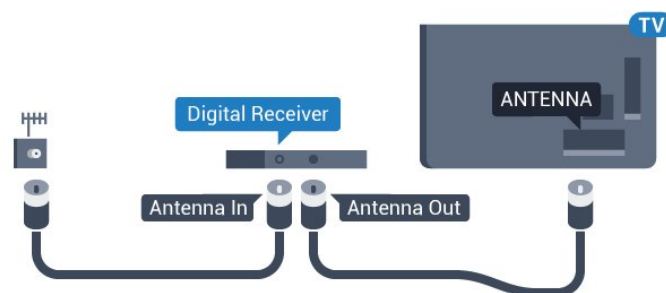

Next to the antenna connections, add an HDMI cable to connect the Set-top box to the TV.

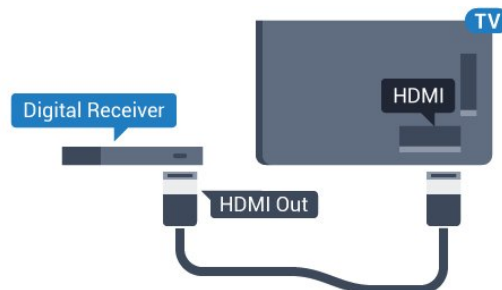

Switch Off Timer

Switch off this automatic timer, if you only use the remote control of the Set-top box. Switch this timer off to prevent the TV from switching off automatically after a 4 hour period without a key press on the remote control of the TV.

For more information, in **Help**, press the colour key **— Keywords** and look up **Switch Off Timer** for more information.

Home Theatre System - HTS

Connect with HDMI ARC

Use an HDMI cable to connect a Home Theatre System (HTS) to the TV. You can connect a Philips Soundbar or an HTS with a built-in disc player.

HDMI ARC

If your Home Theatre System has an HDMI ARC connection, you can use any HDMI connection on the TV to connect. With HDMI ARC, you do not need to connect the extra audio cable. The HDMI ARC connection combines both signals.

All HDMI connections on the TV can offer the Audio Return Channel (ARC) signal. But once you have connected the Home Theatre System, the TV can only send the ARC signal to this HDMI connection.

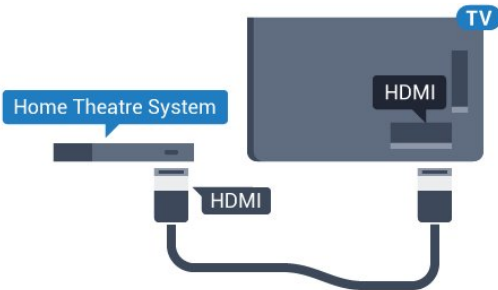

Audio to video synchronisation (sync)

If the sound does not match the video on screen, you can set a delay on most Home Theatre Systems with a disc player to match the sound with the video.

For more information, in **Help**, press the colour key **— Keywords** and look up **Audio to Video Sync**.

Connect with HDMI

Use an HDMI cable to connect a Home Theatre System (HTS) to the TV. You can connect a Philips Soundbar or an HTS with a built-in disc player.

If the Home Theatre System has no HDMI ARC connection, add an optical audio cable (Toslink) to send the sound of the TV picture to the Home Theatre System.

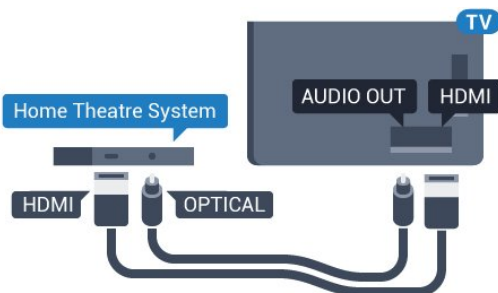

Audio to video synchronisation (sync)

If the sound does not match the video on screen, you can set a delay on most Home Theatre Systems with a disc player to match the sound with the video.

For more information, in **Help**, press the colour key **— Keywords** and look up **Audio to Video Sync**.

Audio Out Settings

Audio Out Delay

With a Home Theatre System (HTS) connected to the TV, the picture on TV and the sound from the HTS should be synchronised.

Automatic audio to video sync

With recent Philips Home Theatre Systems, the audio to video sync is done automatically and always correct.

Audio sync delay

For some Home Theatre Systems you might need to adjust the audio sync delay to synchronise the audio to the video. On the HTS, increase the delay value until there is a match between picture and sound. A delay value of 180ms may be required. Read the user manual of the HTS. With a delay value set up on the HTS, you need to switch off Audio Out Delay on the TV.

To switch off Audio Out Delay...

- 1 - Press **⚙️**, select **All Settings** and press **OK**.
- 2 - Select **Sound** and press **➤** (right) to enter the menu.
- 3 - Select **Advanced > Audio Out Delay** and press **OK**.
- 4 - Select **Off**.
- 5 - Press **⬅️** (left) repeatedly if necessary, to close the menu.

Audio Out Offset

If you cannot set a delay on the Home Theatre System, you can set the TV to sync the sound. You can set an offset that compensates for the time necessary for the Home Theatre System to process the sound of the TV picture. You can set the value in steps of 5ms. Maximum setting is -60ms.

The **Audio Out Delay** setting should be switched on.

To synchronise the sound on the TV...

- 1 - Press **⚙️**, select **All Settings** and press **OK**.
- 2 - Select **Sound** and press **➤** (right) to enter the menu.
- 3 - Select **Advanced > Audio Out Offset** and

press **OK**.

4 - Use the slider bar to set the sound offset and press **OK**.

5 - Press **◀** (left) repeatedly if necessary, to close the menu.

Audio Out Format

If you have a Home Theatre System (HTS) with multichannel sound processing capabilities like Dolby Digital, DTS® or similar, set the Audio Out Format to Multichannel. With Multichannel, the TV can send the compressed multichannel sound signal from a TV channel or connected player to the Home Theatre System. If you have a Home Theatre System without multichannel sound processing, select Stereo.

To set **Audio Out Format**...

1 - Press **⚙**, select **All Settings** and press **OK**.

2 - Select **Sound** and press **▶** (right) to enter the menu.

3 - Select **Advanced > Audio Out Format** and press **OK**.

4 - Select **Multichannel** or **Stereo (uncompressed)**, then press **OK**.

5 - Press **◀** (left) repeatedly if necessary, to close the menu.

Audio Out Levelling

Use the Audio Out Levelling setting to level the volume (loudness) of the TV and the Home Theatre System when you switch over from one to another. Volume differences can be caused by differences in sound processing.

To level the difference in volume...

1 - Press **⚙**, select **All Settings** and press **OK**.

2 - Select **Sound** and press **▶** (right) to enter the menu.

3 - Select **Advanced > Audio Out Levelling** and press **OK**.

4 - Select **More**, **Medium**, or **Less**, then press **OK**.

5 - If the volume difference is large, select **More**. If the volume difference is small, select **Less**.

6 - Press **◀** (left) repeatedly if necessary, to close the menu.

Audio Out Levelling affects both the Audio Out - Optical and HDMI ARC sound signals.

Problems with HTS sound

Sound with loud noise

If you watch a video from a plugged in USB flash drive or connected computer, the sound from your Home Theatre System might be distorted. This noise is heard when the audio or video file has DTS sound but the Home Theatre System has no DTS sound processing. You can fix this by setting the **Audio Out Format** of the TV to **Stereo (uncompressed)**.

Press **⚙** for **All**

Settings > Sound > Advanced > Audio Out Format.

No sound

If you cannot hear the sound from the TV on your Home Theatre System, check if you connected the HDMI cable to an **HDMI ARC** connection on the Home Theatre System. All HDMI connections on the TV are HDMI ARC connections.

4.4

Smartphones and Tablets

To connect a smartphone or tablet to the TV, you can use a wireless or wired connection.

Wireless

For a wireless connection, on your smartphone or tablet download the Philips TV Remote App from your favourite app store.

Wired

For a wired connection, use the **HDMI 4 MHL** connection on the back of the TV. In **Help**, press the colour key **■ Keywords** and look up **HDMI MHL** for more information.

4.5

Blu-ray Disc Player

Use a **High speed HDMI** cable to connect the Blu-ray Disc player to the TV.

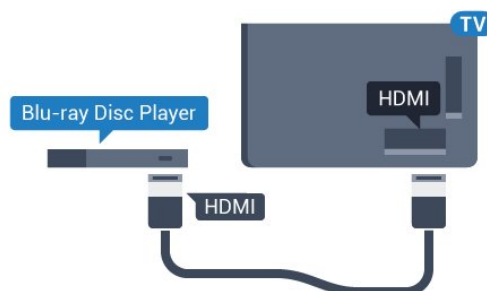

If the Blu-ray Disc player has EasyLink HDMI CEC, you can operate the player with the TV remote

control.

4.6

DVD Player

Use an HDMI cable to connect the DVD player to the TV.

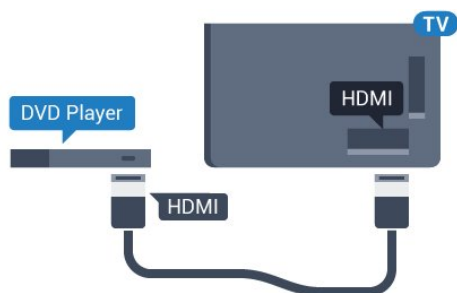

If the DVD player is connected with HDMI and has EasyLink CEC, you can operate the player with the TV remote control.

For more information on EasyLink, in **Help**, press the colour key **Red** **Keywords** and look up **EasyLink HDMI CEC**.

4.7

Bluetooth - Speakers and Gamepads

What You Need

You can connect a wireless device with Bluetooth® to this TV – a wireless speaker, a subwoofer, a sound bar or headphones. You can also connect a wireless gamepad with Bluetooth LE.

To play the TV sound on a wireless speaker, you must pair the wireless speaker with the TV. You can pair some wireless speakers and a maximum of 4 Bluetooth LE (low energy) devices. The TV can only play the sound on one speaker at a time. If you connect a subwoofer, the sound is played on the TV and the subwoofer. If you connect a sound bar the sound is played on the sound bar only.

Attention - Audio to Video synchronisation

Many Bluetooth speaker systems have a high, so called, 'latency'. High latency means that the audio lags behind the video, causing unsynchronised 'lip sync'. Before you purchase a wireless Bluetooth speaker system, inform yourself about the newest models and look for a device with a low latency rating. Ask your dealer for advice.

For more information on how to pair a wireless speaker, in **Help**, press the colour key **Red** **Keywords** and look up **Bluetooth, Pairing**.

Pairing a Device

Position the wireless speaker within a distance of 5 meters from the TV. Read the user manual of the device for specific information on pairing and on wireless range. Make sure the Bluetooth setting on TV is switched on.

Once a wireless gamepad is paired, you can use it. When a wireless speaker is paired, you can select it to play the TV sound. When a device is paired, you do not need to pair it again unless you remove the device.

To pair a wireless speaker with the TV...

- 1 - Switch on the wireless speaker and place it within range of the TV.
- 2 - Press **Settings**, select **All Settings** and press **OK**.
- 3 - Select **Wireless and Networks** and press **Right** to enter the menu.
- 4 - Select **Bluetooth** > **Search Bluetooth Device**, and press **OK**.
- 5 - Select **Search** and press **OK**. Follow the instructions on screen. You will pair the device with the TV and the TV will store the connection.
- 6 - Select the type of device (headphone, subwoofer, ...), select **Next** and press **OK**.
- 7 - Press **Left** repeatedly if necessary, to close the menu.

For more information on how to select the wireless speaker, in **Help**, press the colour key **Red** **Keywords** and look up **Speakers, Select**.

For more information on the Bluetooth On or Off setting, in **Help**, press the colour key **Red** **Keywords** and look up **Bluetooth, On or Off**.

Select a Device

Once a wireless Bluetooth speaker is paired, you can select it to play the TV sound.

To select a speaker to play the TV sound...

- 1 - Press **Settings**, select **Speakers** and press **OK**.
- 2 - Select the loudspeaker system you want and press **OK**.
- 3 - Press **Left** repeatedly if necessary, to close the menu.

Remove a Device

You can connect or disconnect a wireless Bluetooth device. When a Bluetooth device is connected, you can use the gamepad or hear the TV sound through the wireless speaker. You can also remove a wireless Bluetooth device. If you remove a Bluetooth device, the device will be unpaired.

To remove or disconnect a wireless device...

- 1 - Press , select **All Settings** and press **OK**.
- 2 - Select **Wireless and Networks** and press **OK**.
- 3 - Select **Bluetooth > Remove Device** and press **OK**.
- 4 - In the list, select the wireless device and press **OK**.
- 5 - Select **Disconnect** or **Remove** and press **OK**.
- 6 - Select **OK** and press **OK** to confirm.
- 7 - Press **<** (left) repeatedly if necessary, to close the menu.

4.8

Headphones

You can connect a set of headphones to the  connection on the back of the TV. The connection is a mini-jack 3.5mm. You can adjust the volume of the headphones separately.

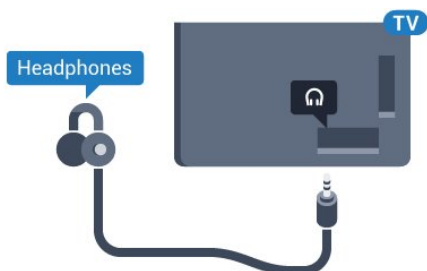

To adjust the volume...

- 1 - Press , select **Headphone Volume** and press **OK**.
- 2 - Press the arrows **^** (up) or **v** (down) to adjust the value.
- 3 - Press **<** (left) repeatedly if necessary, to close the menu.

4.9

Game Console

HDMI

For best quality, connect the game console with a High speed HDMI cable to the TV.

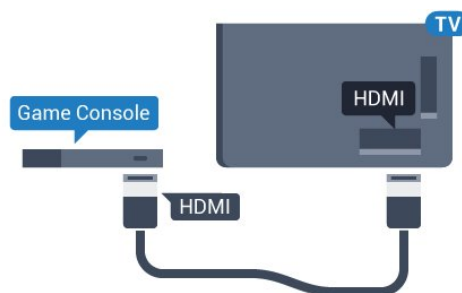

Y Pb Pr

Connect the game console with a component video cable (Y Pb Pr) and an audio L/R cable to the TV.

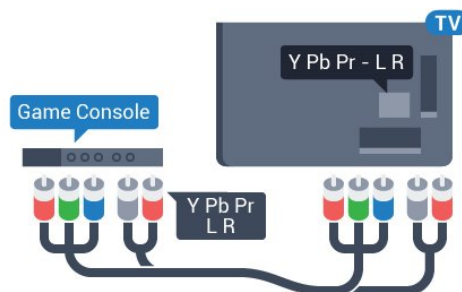

Best Setting

Before you start playing a game from a connected game console, we advise you to set the TV in the ideal setting **Game**.

When you finish playing a game and start watching TV again, remember to switch the **Game** or **Computer** setting back to **Off**.

To set the TV to the ideal setting...

- 1 - Press , select **All Settings** and press **OK**.
- 2 - Select **Picture** and press **>** (right) to enter the menu.
- 3 - Select **Advanced > Game or Computer**, and select the device type you want to use. To switch back to TV, select **Off**.
- 4 - Press **<** (left) repeatedly if necessary, to close the menu.

Gamepad

Connect a Gamepad

To play games from the Internet on this TV, you can connect a selected range of wireless Gamepads. You can use Gamepads with a USB nano receiver or gamepads with Bluetooth.

To connect a Gamepad with a USB nano receiver...

- 1 - Plug in the small nano receiver in one of the USB connections on the side of the TV. The wireless nano receiver comes with the Gamepad.
- 2 - If the Gamepad is switched on, you can use the Gamepad.

You can connect a second Gamepad in the second USB connection on the side of the TV.

Bluetooth

To connect a wireless gamepad with Bluetooth, in **Help**, press the colour key **Keywords** and look up **Bluetooth, Pairing**.

Suitable Gamepads

A selected range of wireless Gamepads are suited and tested for use on this TV. Other Gamepads might not be fully compatible.

The suited Gamepads are...

- Logitech F710
- Logitech F510
- Xbox 360 Wireless Controller for Windows
- Speedlink Strike FX Wireless Gamepad
- Sony Play Station wired
- Mad Catz C.T.R.L. Mobile Gamepad for Android
- Ipega, PG-9023
- Ipega, PG-9025
- PhoneJoy gamepad

Problems

To solve possible interference with other wireless devices on TV...

- Use a USB extension cord and move the nano receiver about 1 meter away from the TV.
- Alternatively, you can use a powered USB hub connected to the TV and plug in the nano receivers in the USB hub.

USB Hard Drive

What You Need

If you connect a USB Hard Drive, you can pause or record a TV broadcast. The TV broadcast must be a digital broadcast (DVB broadcast or similar).

To Pause

To pause a broadcast, you need a USB 2.0 compatible Hard Drive with a minimum of 4GB disk space.

To Record

To pause and record a broadcast, you need a minimum of 250GB disk space. If you want to record a broadcast with TV guide data from the Internet, you need to have the Internet connection installed on your TV before you install the USB Hard Drive.

For more information on how to install a USB Hard Drive, in **Help**, press the colour key **Keywords** and look up **USB Hard Drive, installation**.

Installation

Before you can pause or record a broadcast, you must connect and format a USB Hard Drive. Formatting removes all files from the USB Hard Drive.

- 1 - Connect the USB Hard Drive to one of the **USB** connections on the TV. Do not connect another USB device to the other USB ports when formatting.
- 2 - Switch on the USB Hard Drive and the TV.
- 3 - When the TV is tuned to a digital TV channel, press **||** (Pause). Trying to pause will start the formatting.

Follow the instructions on screen.

When the USB Hard Drive is formatted, leave it connected permanently.

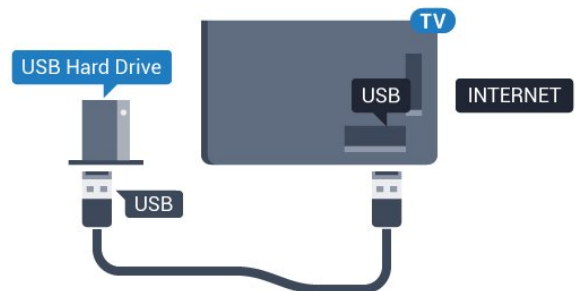

Warning

The USB Hard Drive is formatted exclusively for this TV, you cannot use the stored recordings on another TV or PC. Do not copy or change recording files on

the USB Hard Drive with any PC application. This will corrupt your recordings. When you format another USB Hard Drive, the content on the former will be lost. A USB Hard Drive installed on your TV will need reformatting for use with a computer.

Formatting

Before you can pause or record a broadcast, or store apps, you must connect and format a USB Hard Drive. Formatting removes all files from the USB Hard Drive. If you want to record broadcasts with TV Guide data from the Internet, you must setup the Internet connection first before you install the USB Hard Drive.

Warning

The USB Hard Drive is formatted exclusively for this TV, you cannot use the stored recordings on another TV or PC. Do not copy or change recording files on the USB Hard Drive with any PC application. This will corrupt your recordings. When you format another USB Hard Drive, the content on the former will be lost. A USB Hard Drive installed on your TV will need reformatting for use with a computer.

To format a USB Hard Drive...

- 1 - Connect the USB Hard Drive to one of the **USB** connections on the TV. Do not connect another USB device to the other USB ports when formatting.
- 2 - Switch on the USB Hard Drive and the TV.
- 3 - When the TV is tuned to a digital TV channel, press **||** (Pause). Trying to pause will start the formatting. Follow the instructions on screen.
- 4 - The TV will ask if you want to use the USB Hard Drive to store apps, agree to the question if you do.
- 5 - When the USB Hard Drive is formatted, leave it connected permanently.

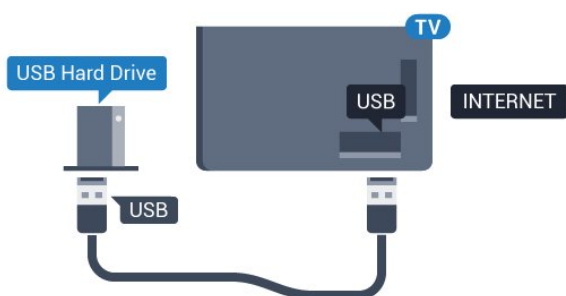

4.12

USB Keyboard

Connect

Connect a USB keyboard (USB-HID type) to enter text on your TV.

Use one of the **USB** connections to connect.

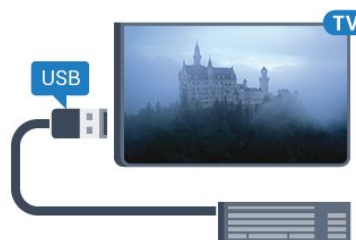

Configure

To install the USB keyboard, switch on the TV and connect the USB keyboard to one of the **USB** connections on the TV. When the TV detects the keyboard for the first time, you can select your keyboard lay-out and test your selection. If you select a Cyrillic or Greek keyboard layout first, you can select a secondary Latin keyboard layout.

To change the keyboard layout setting when a layout was selected...

- 1 - Press **⚙**, select **All Settings** and press **OK**.
- 2 - Select **General Settings** and press **➤** (right) to enter the menu.
- 3 - Select **USB Keyboard Settings**, and press **OK** to start the keyboard setup.

Special Keys

Keys for entering text

- Enter key = OK
- Backspace = delete character before cursor
- Arrow keys = navigate within a text field
- To switch between keyboard layouts, if a secondary layout is set, press the **Ctrl + Spacebar** keys simultaneously.

Keys for apps and Internet pages

- Tab and Shift + Tab = Next and Previous
- Home = scroll to the top of the page
- End = scroll to the bottom of the page
- Page Up = jump one page up
- Page Down = jump one page down
- + = zoom in one step
- - = zoom out one step
- * = fit the web page to the screen width

USB Flash Drive

You can view photos or play your music and videos from a connected USB flash drive.

Insert a USB flash drive in one of the USB connections on the TV while the TV is switched on.



The TV detects the flash drive and opens a list showing its content.

If the contents list does not appear automatically, press **SOURCES** and select **USB**.

To stop watching the USB flash drive content, press **EXIT** or select another activity.

To disconnect the USB flash drive, you can pull out the flash drive anytime.

For more information on watching or playing content from a USB flash drive, in **Help**, press the colour key **Keywords** and look up **Photos, Videos and Music**.

Photo Camera

To view photos stored on your digital photo camera, you can connect the camera directly to the TV.

Use one of the USB connections on the TV to connect. Switch on the camera after you made the connection.

If the contents list does not appear automatically, press **SOURCES**, and select **USB**.

Your camera might need to be set to transfer its content with PTP (Picture Transfer Protocol). Read the user manual of the digital photo camera.

For more information on viewing photos, in **Help**, press the colour key **Keywords** and look up **Photos, Videos and Music**.

Camcorder

HDMI

For best quality, use an HDMI cable to connect the camcorder to the TV.

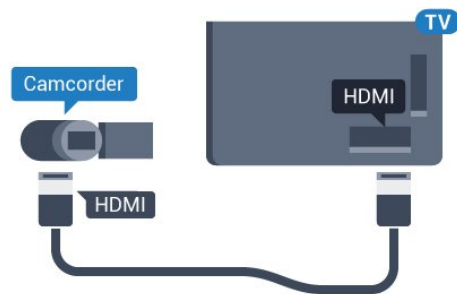

Computer

Connect

You can connect your computer to the TV and use the TV as a PC monitor.

With HDMI

Use an HDMI cable to connect the computer to the TV.

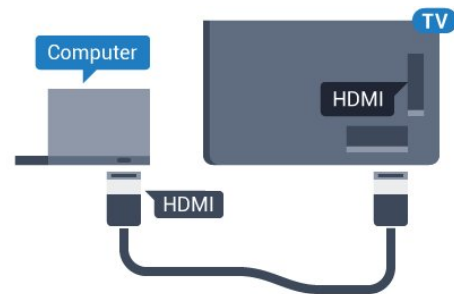

With DVI to HDMI

Alternatively, you can use a DVI to HDMI adapter (sold separately) to connect the PC to HDMI and an audio L/R cable (mini-jack 3.5mm) to AUDIO IN L/R on the back of the TV.

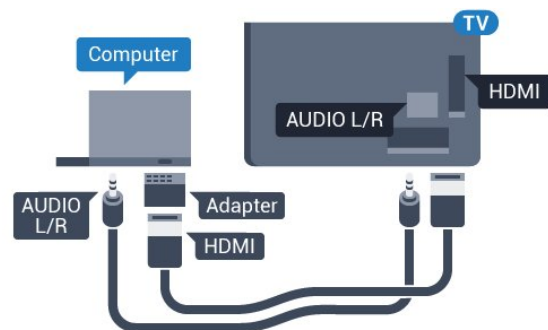

Ideal Setting

If you connect a computer, we advise you to give the connection, on which the computer is connected, the correct device type name in the Source menu. If you then switch to **Computer** in the Source menu, the TV is set to the ideal Computer setting automatically.

You can manually switch the ideal setting to **Off** for watching TV or **Game** for playing a game from a connected game console (remember to switch back to **Off** when you stop playing a game).

If you switch to a source and change the **Game or Computer** setting, it will be stored for this selected source.

To set the TV to the ideal setting...

- 1 - Press , select **All Settings** and press **OK**.
- 2 - Select **Picture** and press **➤** (right) to enter the menu.
- 3 - Select **Advanced > Game or Computer**, and press **OK**.
- 4 - Select **Game** (for gaming) or select **Computer** (for watching a movie).
- 5 - Press **◀** (left) repeatedly if necessary, to close the menu.

Remember to set **Game or Computer** setting to **Off** when you stop playing the game.



Switching On and Off

5.1

On or standby

Make sure the TV is connected to the mains AC power. Connect the supplied power cord to the AC in connector at the back of the TV. The indicator light at the bottom of the TV lights up.

Switch on

Press  on the remote control to switch the TV on. Alternatively, press  HOME. You can also press the small joystick key on the back of the TV to switch the TV on in case you can't find the remote control or its batteries are empty.

Switch to standby

To switch the TV to standby, press  on the remote control. You can also press the small joystick key on the back of the TV.



In standby mode, the TV is still connected to the mains power but consumes very little energy.

To switch off the TV completely, disconnect the power plug.





When disconnecting the power plug, always pull the power plug, never the cord. Ensure that you have full access to the power plug, power cord and outlet socket at all times.

5.2

Keys on TV

If you lost the remote control or its batteries are empty, you can still do some basic TV operations.

To open the basic menu...

- 1 - With the TV switched on, press the joystick key on the back of the TV to bring up the basic menu.
- 2 - Press left or right to select  Volume,  Channel or  Sources. Select  Demo, to start a demo movie.
- 3 - Press up or down to adjust the volume or tune to the next or previous channel. Press up or down to go through the list of sources, including the tuner selection. Press the joystick key to start the demo

movie.

- 4 - The menu will disappear automatically.

To switch the TV on standby, select  and press the joystick key.





5.3

Sleep Timer

With the **Sleep Timer**, you can set the TV to switch to Standby automatically after a preset time.

To set the Sleep Timer...

- 1 - Press , select **Sleep Timer** and press .
- 2 - With the slider bar you can set the time to up to 180 minutes in increments of 5 minutes. If set to 0 minutes, the Sleep Timer is switched off. You can always switch off your TV earlier or reset the time during the countdown.
- 3 - Press  BACK to close the menu.







5.4

Switch Off Timer

If the TV receives a TV signal but you don't press a key on the remote control during a 4 hour period, the TV switches off automatically to save energy. Also, if the TV does not receive a TV signal nor a remote control command for 10 minutes, the TV switches off automatically.

If you use the TV as a monitor or use a digital receiver to watch TV (a Set-Top Box - STB) and you do not use the remote control of the TV, you should deactivate this automatic switch off.

To deactivate the Switch Off Timer ...

- 1 - Press , select **All Settings** and press .
- 2 - Select **Eco Settings** and press  (right) to enter the menu.
- 3 - Select **Switch Off Timer** and press .
- 4 - Press the arrows  (up) or  (down) to adjust the value. The value 0 deactivates the automatic switch off.
- 5 - Press  (left) repeatedly if necessary, to close the menu.

For more information on environmentally friendly TV settings, in **Help**, press the colour key  **Keywords** and look up **Eco Settings**.

Remote Control

Key overview

Top

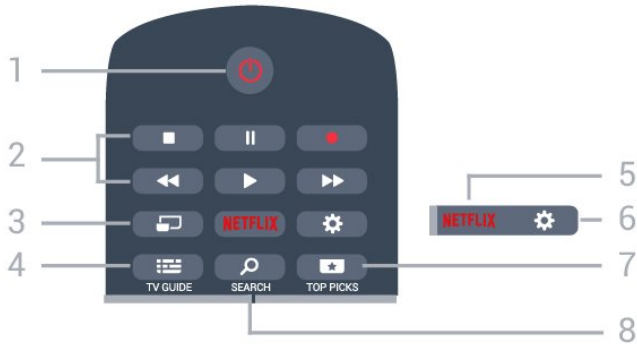

1 - Standby / On

To switch the TV on or back to Standby.

2 - Playback and Record

- Play , to playback.
- Pause , to pause playback
- Stop , to stop playback
- Rewind , to rewind
- Fast forward , to go fast forward
- Record , to start recording

3 - MULTIVIEW

To open a small screen in the big screen.

4 - TV GUIDE

To open or close the TV Guide.

5 - **NETFLIX**

To open the Netflix App directly. With the TV switched on or from standby.

6 - Settings

To open the Frequent Settings menu and All Settings.

7 - TOP PICKS

To open the menu with recommended programmes, Video on Demand (Rental Videos) or Online TV (Catch Up TV).

8 - SEARCH

To open the searches page.

Middle



1 -

To open the TV Menu with typical TV functions.

2 - SOURCES

To open the Sources menu.

3 - Colour keys

Direct selection of options. Blue key , opens Help.

4 - INFO

To open or close programme info.

5 - BACK

To switch back to the previous channel you selected.

To close a menu without changing a setting.

To go back to the previous App/Internet page.

6 - - EXIT

To switch back to watch TV. To stop an interactive TV application.

7 - OPTIONS

To open or close the Options menu.

8 - OK key

To confirm a selection or setting. To open the channel list while watching TV.

9 - Arrow / navigation keys

To navigate up, down, left or right.

10 - HOME

To open the Home menu.

Bottom



- 1 - **🔇 Mute**
To mute the sound or to restore it.
- 2 - **🔊 Volume**
To adjust the volume level.
- 3 - **Number keys**
To select a channel directly.
- 4 - **SUBTITLE**
To switch subtitles on, off or to show automatically.
- 5 - **≡ Channel**
To switch to the next or previous channel in the channel list. To open the next or previous page in Text/Teletext. To start the next or previous chapter on a disc.
- 6 - **TEXT**
To open or close Text/Teletext.

6.2

Voice search

Download App from Google play

Use your Android smartphone or tablet as a remote for your Android TV. Easily switch between d-pad, touchpad, and gamepad modes to navigate content and play games on your Android TV device. Tap the microphone to start a voice search, or use the keyboard to input text on Android TV.

To get started, connect your Android phone or tablet to the same network as your Android TV device or find your Android TV via bluetooth.

Works with all Android TV devices.

*You need an Android phone or tablet running Android 4.3 or higher to use the Android TV Remote Control app.

Voice Search

Pairing with your TV

There is no microphone on your remote control, if you want to use voice search, you must install **Android TV Remote Control app** on your Android smartphone or tablet first.

- 1 - On your Android smartphone or tablet, search "Android TV Remote Control" in Google Play store.
- 2 - Download and install **Android TV Remote Control app*** on your Android smartphone or tablet .
- 3 - Connect your Android smartphone or tablet to the same network as your Android TV device.
- 4 - Select "PhilipsTv"*** on your Android smartphone or tablet, then your Android TV will show a code on the screen.
- 5 - Enter the code on your Android smartphone or tablet to pair to your Android TV.

*You need an Android phone or tablet running Android 4.3 or higher to use the Android TV Remote Control app.

**The name of your Android TV is depends on the name you set in TV Network Name. The pre-set name is model name of this TV.

For more information, in **Help**, press the colour key **Keywords** and look up **Network, TV Network Name**.

Using Voice search

You can search for videos, music or anything else on the Internet with the **🔊** icon at the top of the Home menu. You can start using Voice Search any time. Alternatively, you can use the remote control keyboard to enter text.

To use Voice Search...





- 1 - Tap **🔊** icon on your smartphone to start a voice search.
- 2 - The **🔊** icon is red on screen, the microphone is active.
- 3 - Speak out clearly what you are looking for. It might take some time for the results to appear.
- 4 - In the screen with search results, you can select the item you want.

See also www.support.google.com/androidtv

Voice Search settings

You can set the language you like to use with Voice Search.

To set the language for Voice Search...

- 1 - Press , select **All Settings** and press **OK**.
- 2 - Select **Android Settings** and press **OK**.
- 3 - Select **Preferences >  Speech** and press **OK**.
- 4 - Select the language you want to use and press **OK**.
- 5 - Press  **BACK** to go back one step or press  **EXIT** to close the menu.

6.3

IR Sensor

The TV can receive commands from a remote control that uses IR (infrared) to send commands. If you use such a remote control, always make sure you point the remote control at the infrared sensor on the front of the TV.

6.4

Batteries

If the TV does not react on a key press on the remote control, the batteries might be empty.

To replace the batteries, open the battery compartment on the back of the remote control.

- 1 - Slide the battery door in the direction shown by the arrow.
- 2 - Replace the old batteries with 2 type **AAA-R03-1.5V** batteries. Make sure the + and the - ends of the batteries line up correctly.
- 3 - Reposition the battery door and slide it back until it clicks.

Remove the batteries if you are not using the remote control for a long time.

Safely dispose of your old batteries according to the end of use directions.

For more information, in **Help**, press the colour key  **Keywords** and look up **End of use**.

6.5

Cleaning

Your remote control is treated with a scratch-resistant coating.

To clean the remote control, use a soft damp cloth. Never use substances such as alcohol, chemicals or household cleaners on the remote control.

Channels

7.1

Install Channels

For more information, in **Help**, press the colour key **Red** **Keywords** and look up **Channel, Antenna Installation** or **Channel, Cable Installation**.

7.2

Channel Lists

About Channel Lists

After a channel installation, all channels appear on the channel list. Channels are shown with their name and logo if this information is available.

There is a channel list with all installed channels. You can only filter this list to show TV or only Radio channels.

With a channel list selected, press the arrows **▲** (up) or **▼** (down) to select a channel, then press **OK** to watch the selected channel. You only tune to the channels in that list when using **≡ +** or **≡ -** keys.

Channel icons

After an Automatic Channel Update of the channel list, newly found channels are marked with a **★** (star).

If you lock a channel, it will be marked with a **🔒** (lock).

The 3 most popular channels being watched by others at this moment are marked with a **1**, **2** or **3**.

Radio stations

If digital broadcasting is available, digital radio stations are installed during installation. Switch to a radio channel just like you switch to a TV channel. A Cable (DVB-C) channel installation usually places radio stations from channel number 1001 onwards.

* This TV can receive digital television standard DVB. TV may not work properly with some operators of digital television, non-compliance with requirements of the standard in full.

Open a Channel List

Next to the list with all channels, you can select a filtered list or you can select one of the favourite lists you created.

To open the current channel list...

- 1 - Press **TV**, to switch to TV.
- 2 - Press **OK** to open the current channel list.
- 3 - Press **← BACK** to close the channel list.

To select one of the channel lists...

- 1 - With a channel list open on screen, press **≡ OPTIONS**.
- 2 - Select **Select Channel List** and press **OK**.
- 3 - In the list menu, select one of the available channel lists and press **OK**.

Alternatively, you can select the list name at the top of the channel list and press **OK** to open the list menu.

Filter a Channel List

You can filter a list with all channels. You can set the channel list to show only TV channels or only Radio stations. For Antenna/Cable channels you can set the list to show the Free-to-Air or the Scrambled channels.

To set a filter on a list with all channels...

- 1 - Press **TV**.
- 2 - Press **OK** to open the current channel list.
- 3 - Press **≡ OPTIONS**.
- 4 - Select **Select Channel List** and press **OK**.
- 5 - Select **Filter Antenna Channels** or **Filter Cable Channels** according to the list you want to filter.
- 6 - In the **Options** menu, select the filter you want and press **OK** to activate. The name of the filter appears as part of the channel list name on top of the channel list.
- 7 - Press **◀** (left) to go back one step or press **←** to close the menu.

Search for a Channel

You can search for a channel to find it in a long list of channels.

The TV can search for a channel within one of the 2 main channel lists - the Antenna or Cable channel list.

To search for a channel...

- 1 - Press **TV**.
- 2 - Press **OK** to open the current channel list.
- 3 - Press **≡ OPTIONS**.
- 4 - Select **Select Channel List** and press **OK**.
- 5 - Select **Filter Antenna Channels** or **Filter Cable**

Channels and press **OK**.

6 - Select **Search Channel** and press **OK** to open a text field. You can use the remote control keyboard (if available) or the on-screen keyboard to enter text.

7 - Enter a number, a name or part of a name and select **Apply** and press **OK**. The TV will search for matching channel names in the list you selected.

Search results are listed as a channel list - see the list name at the top. The search results disappear once you select another channel list or close the list with search results.

7.3

Watching channels

Tune to a Channel

To start watching TV channels, press **TV**. The TV tunes to the channel you last watched.

Switch Channels

To switch channels, press **≡ +** or **≡ -**.

If you know the channel number, type in the number with the number keys. Press **OK** after you entered the number to switch immediately.

Now and next

While you're watching a TV channel, you can quickly scroll through the rest of the channels and see what's on.

Press **▲** (up) or **▼** (down) to open a scrolling list of channels. If the information is available, the TV shows the current programme name and details followed by the next programme name and details.

Previous channel

To switch back to the previously tuned channel, press **← BACK**.

Lock a Channel

Lock and Unlock a Channel

To prevent children from watching a channel, you can lock a channel. To watch a locked channel, you must enter the 4 digit **Child Lock** PIN code first. You cannot lock programmes from connected devices.

To lock a channel...

1 - Press **TV**.

2 - Press **OK** to open the channel list. If necessary change the channel list.

3 - Select the channel you want to lock.

4 - Press **≡ OPTIONS** and select **Lock Channel** and press **OK**.

5 - Enter your 4 digit PIN code if the TV asks for it. A

locked channel is marked with a **🔒** (lock).

6 - Press **◀** (left) to go back one step or press **←** to close the menu.

To unlock a channel...

1 - Press **TV**.

2 - Press **OK** to open the channel list. If necessary change the channel list.

3 - Select the channel you want to unlock.

4 - Press **≡ OPTIONS** and select **Unlock Channel** and press **OK**.

5 - Enter your 4 digit PIN code if the TV asks for it.

6 - Press **◀** (left) to go back one step or press **←** to close the menu.

If you lock or unlock channels in a channel list, you only have to enter the PIN code just once until you close the channel list.

For more information, in **Help**, press the colour key **— Keywords** and look up **Child Lock** for more information.

Parental Rating

To prevent children from watching a programme not suitable for their age, you can set an age rating.

Digital channels can have their programmes age rated. When the age rating of a programme is equal to or higher than the age you have set as age rating for your child, the programme will be locked. To watch a locked programme, you must enter the **Parental Rating** code first.

To set an age rating...

1 - Press **⚙️**, select **All Settings** and press **OK**.

2 - Select **Child Lock > Parental Rating** and press **OK**.

3 - Enter a 4-digit Child lock code. If you did not set a code yet, select **Set Code** in **Child Lock**. Enter a 4-digit Child lock code and confirm. Now you can set an age rating.

4 - Back in **Parental Rating**, select the age and press **OK**.

5 - Press **◀** (left) repeatedly if necessary, to close the menu.

To switch off the parental age rating, select **None**. However, in some countries you must set an age rating.

For some broadcasters/operators, the TV only locks programmes with a higher rating. The parental age rating is set for all channels.

Channel Options

Open Options

While watching a channel, you can set some options.

Depending on the type of channel you are watching (analogue or digital) or depending on the TV settings you made, some options are available.

To open the options menu...

- 1 - While watching a channel, press  **OPTIONS**.
- 2 - Press  **OPTIONS** again to close.

Subtitles

Switch On

To switch on Subtitles, press **SUBTITLE**.

You can switch subtitles **On** or **Off**. Alternatively you can select **Automatic**.

Automatic

If language information is part of the digital broadcast and the broadcasted programme is not in your language (the language set on TV), the TV can show subtitles automatically in one of your preferred subtitle languages. One of these subtitle languages must also be part of the broadcast.

You can select your preferred subtitle languages in **Subtitle Language**.

Subtitles from Text

If you tune to an analogue channel, you need to make the subtitles available for each channel manually.

- 1 - Switch to a channel and press **TEXT** to open Text.
- 2 - Enter the page number for subtitles, usually **888**.
- 3 - Press **TEXT** again, to close Text.

If you select **On** in the Subtitle menu when watching this analogue channel, subtitles will be shown if available.

To know if a channel is analogue or digital, switch to the channel and open **Channel Info** in  **OPTIONS**.

Subtitle Language

Preferred Subtitle Languages

A digital broadcast can offer several subtitle languages for a programme. You can set a preferred primary and secondary subtitle language. If subtitles

in one of these languages are available, the TV will show the subtitles you selected.

To set the primary and secondary subtitle language...

- 1 - Press , select **All Settings** and press **OK**.
- 2 - Select **Region and Language** > **Languages** > **Primary Subtitles** or **Secondary Subtitles**.
- 3 - Select the language you need and press **OK**.
- 4 - Press **<** (left) to go back one step or press **<** to close the menu.

Select a Subtitle Language

If none of the preferred subtitle languages are available, you can select another subtitle language if available. If no subtitle languages are available, you cannot select this option.

To select a subtitle language when none of your preferred languages are available...

- 1 - Press  **OPTIONS**.
- 2 - Select **Subtitle Language** and select one of the languages as subtitles temporarily.

Audio Language

Preferred Audio Language

A digital broadcast can offer several audio languages (spoken languages) for a programme. You can set a preferred primary and secondary audio language. If audio in one of these languages is available, the TV will switch to the audio language.

To set the primary and secondary audio language...

- 1 - Press , select **All Settings** and press **OK**.
- 2 - Select **Region and Language** and select **Languages** > **Primary Audio** or **Secondary Audio**.
- 3 - Select the language you need and press **OK**.
- 4 - Press **<** (left) to go back one step or press **<** to close the menu.

Select an Audio Language

If none of the preferred audio languages are available, you can select another audio language if available. If no audio languages are available, you cannot select this option.

To select an audio language when none of your preferred languages are available...

- 1 - Press  **OPTIONS**.
- 2 - Select **Audio Language** and select one of the languages as audio temporarily.

HbbTV on this Channel

If you want to avoid access to HbbTV pages on a specific channel, you can block the HbbTV pages for this channel only.

1 - Tune to the channel of which you want to block the HbbTV pages.

2 - Press **≡** **OPTIONS** and select **HbbTV on this Channel** and press **➤** (right).

3 - Select **Off** and press **OK**.

4 - Press **◀** (left) to go back one step or press **←** **BACK** to close the menu.

To block HbbTV on TV completely...

1 - Press **⚙**, select **All Settings** and press **OK**.

2 - Select **General Settings > Advanced > HbbTV**.

3 - Select **Off** and press **OK**.

4 - Press **◀** (left) to go back one step or press **←** **BACK** to close the menu.

Channel Info

You can view the technical characteristics of a particular channel, like digital or analogue, sound type, etc.

To view the technical information on a channel...

1 - Tune to the channel.

2 - Press **≡** **OPTIONS**, select **Channel Info** and press **OK**.

3 - To close this screen, press **OK**.

Mono / Stereo

You can switch the sound of an analogue channel to Mono or Stereo.

To switch to Mono or Stereo...

1 - Tune to an analogue channel.

2 - Press **≡** **OPTIONS**, select **Mono/Stereo** and press **➤** (right).

3 - Select **Mono** or **Stereo** and press **OK**.

4 - Press **◀** (left) to go back one step or press **←** **BACK** to close the menu.

Video Selection

Digital TV channels can offer multi video signals (multi-feed broadcast), different camera viewpoints or angles of the same event or different programmes on one TV channel. The TV shows a message if any such TV channels are available.

Dual I-II

If an audio signal contains two audio languages but one language or both has no language indication, this option is available.

Reorder Channels

Only in a Favourites List you can change the sequence of channels (reorder).

To change the sequence of channels...

1 - Open the Favourites List you want to reorder.

2 - Press **≡** **OPTIONS**, select **Reorder Channels** and press **OK**.

3 - In the Favourites List, select the channel you want to reorder and press **OK**.

4 - With the **▲** (up) or **▼** (down) keys move the channel where you want it.

5 - Press **OK** to confirm the new location.

6 - You can reorder channels with the same method until you close the Favourites List with

the **←** **BACK** key.

7.4

Favourite Channels

About Favourite Channels

In a favourite channel list, you can collect the channels you like.

You can create 4 different lists of favourite channels for easy channel zapping. You can name each Favourites List individually. Only in a Favourites List you can reorder channels.

With a Favourites List selected, press the arrows **▲** (up) or **▼** (down) to select a channel, then press **OK** to watch the selected channel. You only tune to the channels in that list when using **≡ +** or **≡ -** keys.

Create a Favourites List

To create a favourite channels list...

1 - Press **TV**, to switch to TV.

2 - Press **OK** to open the current channel list.

3 - Press **≡** **OPTIONS**.

4 - Select **Create Favourites List** and press **OK**.

5 - In the list at the left, select a channel you want as a favourite and press **OK**. Channels come in the list at the right in the order you add them. To undo, select the channel in the list at the left and press **OK** again.

6 - If necessary, you can go on selecting and adding

channels as favourites.

7 - To finish adding channels, press **← BACK**.

The TV will ask to rename the Favourites List. You can use the on screen keyboard or use the keyboard on the back of the remote control.

- 1 - Press **← BACK** to hide the on screen keyboard.
- 2 - Use the keyboard on the back of the remote control to delete the current name and enter a new name.
- 3 - When done, turn the remote control, select **Close** and press **OK**.

The TV will switch to the newly created Favourites List.

You can add a range of channels in one go or start a Favourites List by duplicating the channel list with all channels and removing the channels you do not want.

The channels in the Favourites List are renumbered.

Add a Range of Channels

To add a consecutive range of channels to a Favourites List in one go, you can use Select Range.

To add a range of channels...

- 1 - Open the Favourites List where you want to add a range of channels.
- 2 - Press **≡ OPTIONS**, select **Select Range** and press **OK**.
- 3 - In the list at the left select the first channel of the range you want to add and press **OK**.
- 4 - Press **▼** (down) to select the last channel of the range you want to add. The channels are marked at the left.
- 5 - Press **OK** to add this range of channels and confirm.

You can also start creating a Favourites List from Select Range.

Rename a Favourites List

You can only rename a Favourites List.

To rename a Favourites List...

- 1 - Open the Favourite List you want to rename.
- 2 - Press **≡ OPTIONS**, select **Rename Favourites List** and press **OK**.
- 3 - Press **← BACK** to hide the on screen keyboard.
- 4 - Use the keyboard on the back of the remote control to delete the current name and enter a new name.
- 5 - When done, turn the remote control, select **Close** and press **OK**.
- 6 - Press **← BACK** to close the channel list.

Remove a Favourites List

You can only remove a Favourites List.

To remove a Favourites List...

- 1 - Open the Favourites List you want to remove.
- 2 - Press **≡ OPTIONS**, select **Remove Favourites List** and press **OK**.
- 3 - Confirm to remove the list.
- 4 - Press **← BACK** to close the channel list.

Reorder Channels

Only in a Favourites List you can change the sequence of channels (reorder).

To change the sequence of channels...

- 1 - Open the Favourites List you want to reorder.
- 2 - Press **≡ OPTIONS**, select **Reorder Channels** and press **OK**.
- 3 - In the Favourites List, select the channel you want to reorder and press **OK**.
- 4 - With the **▲** (up) or **▼** (down) keys move the channel where you want it.
- 5 - Press **OK** to confirm the new location.
- 6 - You can reorder channels with the same method until you close the Favourites List with the **← BACK** key.

7.5

Text / Teletext

Text Pages

To open Text/Teletext press **TEXT**, while you are watching TV channels.

To close Text, press **TEXT** again.

Select a Text page

To select a page . . .

- 1 - Enter the page number with the number keys.
- 2 - Use the arrow keys to navigate.
- 3 - Press a colour key to select a colour-coded subject at the bottom of the screen.

Text sub-pages

A Text page number can hold several subpages. The subpage numbers are shown on a bar next to the main page number.

To select a subpage, press **◀** or **▶**.

T.O.P. Text pages

Some broadcasters offer T.O.P. Text.

To open T.O.P. Text pages within Text, press **≡ OPTIONS** and select **T.O.P. overview**.

Favourite pages

The TV makes a list of the last 10 Text pages you opened. You can easily reopen them again in the Favourite Text pages column.

1 - In Text, select the star in the top left corner of the screen to show the column of favourite pages.

2 - Press **▼** (down) or **▲** (up) to select a page number and press **OK** to open the page.

You can clear the list with the option **Clear favourite pages**.

Search Text

You can select a word and scan Text for all occurrences of this word.

1 - Open a Text page and press **OK**.

2 - Select a word or number with the arrow keys.

3 - Press **OK** again to jump immediately to the next occurrence of this word or number.

4 - Press **OK** again to jump to the subsequent occurrence.

5 - To stop searching, press **▲** (up) until nothing is selected.

Text from a connected device

Some devices that receive TV channels can also offer Text.

To open Text from a connected device . . .

1 - Press **☑ SOURCES** select the device and press **OK**.

2 - While watching a channel on the device, press **≡ OPTIONS**, select **Show device keys** and select the **☑** key and press **OK**.

3 - Press **← BACK** to hide the device keys.

4 - To close Text, press **← BACK** again.

Digital Text (UK only)

Some digital broadcasters offer dedicated Digital Text or interactive TV on their digital TV channels. This includes normal Text using the number, colour and arrow keys to select and navigate.

To close Digital Text, press **← BACK**.

Text Options

In Text/Teletext, press **≡ OPTIONS** to select the following...

- **Freeze page**

To stop the automatic rotation of subpages.

- **Dual screen / Full screen**

To show the TV channel and Text alongside each other.

- **T.O.P. overview**

To open T.O.P. Text.

- **Enlarge**

To enlarge the Text page for comfortable reading.

- **Reveal**

To unhide hidden information on a page.

- **Cycle subpages**

To cycle subpages when these are available.

- **Language**

To switch the group of characters that Text uses to display correctly.

- **Text 2.5**

To activate the Text 2.5 for more colours and better graphics.

Text Setup

Text language

Some digital TV broadcasters have several Text languages available.

To set your primary and secondary Text language . . .

1 - Press **⚙**, select **All Settings** and press **OK**.

2 - Select **Region and Language** and press **▶** (right) to enter the menu.

3 - Select **Language > Primary Text** or **Secondary Text** and press **OK**.

4 - Select your preferred Text languages.

5 - Press **◀** (left) repeatedly if necessary, to close the menu.

Text 2.5

If available, Text 2.5 offers more colours and better graphics. Text 2.5 is activated as a standard factory setting.

To switch off Text 2.5...

1 - Press **TEXT**.

2 - With Text/Teletext open on screen, press **≡ OPTIONS**.

3 - Select **Text 2.5 > Off**.

4 - Press **◀** (left) repeatedly if necessary, to close the menu.

7.6

Interactive TV

About iTV

With interactive TV, some digital broadcasters combine their normal TV programme with information or entertainment pages. On some pages, you can respond to a programme or vote, do online shopping or pay for a video-on-demand programme.

HbbTV, MHEG, . . .

Broadcasters use various interactive TV systems : HbbTV (Hybrid Broadcast Broadband TV) or iTV (Interactive TV - MHEG). Interactive TV is sometimes referred to as Digital Text or Red button. But each system is distinct.

Visit the broadcaster's Internet website for more information.

What You Need

Interactive TV is only available on digital TV channels. To enjoy the full benefits of Interactive TV, you need a high-speed (broadband) Internet connection to the TV.

HbbTV

If a TV channel offers HbbTV pages, you must first switch on HbbTV in the TV settings to view the pages.

- 1 - Press , select **All Settings** and press **OK**.
- 2 - Select **General Settings > Advanced > HbbTV** and press **OK**.
- 3 - Select **On**.
- 4 - Press **◀** (left) repeatedly if necessary, to close the menu.

If you want to avoid access to HbbTV pages on a specific channel, you can block the HbbTV pages for this channel only.

- 1 - Tune to the channel of which you want to block the HbbTV pages.
- 2 - Press  **OPTIONS** and select **HbbTV on This Channel**.
- 3 - Select **Off**.

Use iTV

Open iTV pages

Most channels that offer HbbTV or iTV invite you to press the colour key  (red) or **OK** key to open their interactive programme.

Navigate iTV pages

You can use the arrow and colour keys, the number keys and the **← BACK** key to navigate the iTV pages.

You can use the **▶** (Play), **⏸** (Pause) and **■** (Stop) keys to watch videos within iTV pages.

Digital Text (UK only)

To open Digital Text, press **TEXT**. To close, press **← BACK**.

Close iTV pages

Most iTV pages inform you which key to use to close. To force an iTV page to close, switch to the next TV channel and press **← BACK**.

TV Guide

8.1

What You Need

With the TV Guide you can view a list of the current and scheduled TV programmes of your channels. Depending on where the TV guide information (data) is coming from, analogue and digital channels or only digital channels are shown. Not all channels offer TV Guide information.

The TV can collect TV Guide information for the channels that are installed on the TV. The TV cannot collect the TV Guide information for channels viewed from a digital receiver or decoder.

8.2

TV Guide Data

The TV Guide receives information (data) from broadcasters or from the Internet. In some regions and for some channels, TV Guide information might not be available. The TV can collect TV Guide information for the channels that are installed on the TV. The TV cannot collect the TV Guide information from channels viewed from a digital receiver or decoder.

The TV comes with the information set to **From the Broadcaster**.

If TV Guide information comes from the Internet, the TV Guide can also list analogue channels next to the digital channels. The TV Guide menu also shows a small screen with the current channel.

From the Internet

If the TV is connected to the Internet, you can set the TV to receive the TV Guide information from the Internet.

To set the TV Guide information...

- 1 - Press , select **All Settings** and press **OK**.
- 2 - Select **General Settings** and press **➤** (right) to enter the menu.
- 3 - Select **Advanced > TV Guide > From the Internet** and press **OK**.
- 4 - Press **◀** (left) repeatedly if necessary, to close the menu.

Missing recordings

When some recordings seem to have disappeared from the list of recordings, the TV Guide info (data) might have changed. Recordings made with the setting **From the Broadcaster** become invisible in the list if you switch the setting to **From the**

Internet or vice versa. The TV might have switched to **From the Internet** automatically.

To make the recordings available in the list of recordings, switch to the setting that was selected when the recordings were made.

8.3

Using the TV Guide

Open the TV Guide

To open the TV Guide, press  **TV GUIDE**. The TV Guide shows the channels of the selected tuner.

Press  **TV GUIDE** again to close.

The first time you open the TV Guide, the TV scans all TV channels for programme information. This may take several minutes. TV Guide data is stored on TV.

Tune to a Programme

From the TV Guide, you can tune to a current programme.

To switch to the programme (channel), select the programme and press **OK**.

View programme details

To call up the details of the selected programme...

- 1 - Press  **INFO**.
- 2 - Press  **BACK** to close.

Change Day

The TV Guide can show the scheduled programmes for the upcoming days (maximum up to 8 days).



Press the colour key  **Day** and select the day you need.

Set a Reminder



You can set a reminder for a programme. A message will alert you at the start of the programme. You can tune to this channel immediately.

In the TV Guide a programme with a reminder is marked with a  (clock).

To set a reminder...

- 1 - Press  **TV GUIDE** and select an upcoming programme.
- 2 - Press  **OPTIONS**.
- 3 - Select **Set Reminder** and press **OK**.
- 4 - Press  **BACK** to close the menu.



To clear a reminder...

- 1 - Press  TV GUIDE and select a programme with the reminder.
- 2 - Press  OPTIONS.
- 3 - Select **Clear Reminder** and press **OK**.
- 4 - Press  BACK to close the menu.

Search by Genre

If the information is available, you can look up scheduled programmes by genre like movies, sports, etc.

To search for programmes by genre...







- 1 - Press  TV GUIDE.
- 2 - Press  OPTIONS.
- 3 - Select **Search by Genre** and press **OK**.
- 4 - Select the genre you want and press **OK**. A list with the found programmes appears.
- 5 - You can set reminders or schedule a recording on a selected programme.
- 6 - Press  BACK to close the menu.

List of Reminders

You can view a list of the reminders you have set.

List of Reminders



To open the list of reminders...

- 1 - Press  TV GUIDE.
- 2 - Press the colour key  Recordings .
- 3 - At the top of the screen, select  Scheduled and press **OK**.
- 4 - In the list of scheduled recordings and reminders, select the tab **Reminders** and press **OK** to view the reminders only.
- 5 - Press the colour key  Remove to remove the selected reminder. Press the colour key  Record to record the selected programme.
- 6 - Press  BACK to close the menu.



Set a Recording

You can set a recording in the TV Guide*.

In the TV Guide, a programme set to be recorded is marked with  .



To see the recording list, press  Recordings , a programme set to be recorded is marked with a  (red dot) on the front of the programme name.

To record a programme...

- 1 - Press  TV GUIDE and select a future or ongoing programme.
- 2 - Press the colour key  Record .

- 3 - Press  BACK to close the menu.

To cancel a recording...

- 1 - Press  TV GUIDE and select the programme set for recording.
- 2 - Press the colour key  Clear Recording .
- 3 - Press  BACK to close the menu.

* See chapter **Recording and Pause TV** for more information.

Recording and Pause TV

Recording

What You Need

You can record a digital TV broadcast and watch it later.

To record a TV programme you need...

- a connected USB Hard Drive formatted on this TV
- digital TV channels installed on this TV
- to receive channel information for the on screen TV Guide
- a reliable TV clock setting. If you reset the TV clock manually, recordings may fail.

You cannot record when you are using Pause TV.

In terms enforcement of copyright legislation, some DVB providers can apply different restriction by means of DRM (Digital Right Management) technology. In case of broadcasting protected channels, recording, record validity or number of views may be restricted. Recording may be completely prohibited. In case of trying to record a protected broadcasting or play back an expired recording, an error message can appear.

For more information on installing a USB Hard Drive, in **Help**, press the colour key **Keywords** and look up **USB Hard Drive, installation**.

Record a Programme

Record Now

To record the programme you are watching right now, press **Record** on the remote control. The recording will start immediately.

To stop the recording, press **Stop**.

When TV Guide data is available, the programme you are watching will be recorded from the moment you pressed the recording key until the programme ends. If no TV Guide data is available, the recording will only last 30 minutes. You can adjust the end time of the recording in the list of **Recordings**.

Schedule a Recording

You can schedule a recording of an upcoming programme for today or a few days from today (maximum of 8 days away). The TV will use the data from the TV Guide to start and end the recording.

To record a programme...

- 1 - Press **TV GUIDE**.
- 2 - On the TV Guide, select the channel and programme you wish to record. Press **Right** or **Left** to scroll through the programmes of a channel. Use the colour key **Day** to select the day you need.
- 3 - With the programme highlighted, press the colour key **Record**. The programme is scheduled for recording. A warning will show automatically when overlapping recordings are scheduled. If you plan to record a programme in your absence, remember to leave the TV switched to Standby and the USB Hard Drive switched on.
- 4 - The TV adds some time margin at the end of the programme. You can adjust this margin with **Auto End Margin**.
- 5 - Press **BACK** to close the menu.

List of Recordings

You can view and manage your recordings in the list of recordings. Next to the list of recordings, there is a separate list for scheduled recordings and reminders.

To open the list or recordings...

- 1 - Press **TV GUIDE**.
- 2 - Press the colour key **Recordings**.
- 3 - In the list of recordings, select the tabs **New**, **Watched** or **Expired** and press **OK** to filter your view.
- 4 - With a recording selected in the list, you can remove the recording with the colour key **Remove** or stop an ongoing recording with the colour key **Stop Recording**. You can rename a recording with the colour key **Rename**.
- 5 - Press **BACK** to close the menu.

Broadcasters can limit the number of days a recording can be viewed. When this period expires, the recording will be marked as expired. A recording in the list can show the number of days before it expires.

When a scheduled recording was prevented by the broadcaster or when the broadcast was interrupted, a recording is marked as **Failed**.

Recording Conflicts

When two scheduled recordings are overlapping in time, there is a recording conflict. To solve a recording conflict, you can adjust the start and end time of one

or both scheduled recordings.

To adjust the start or end time of a scheduled recording...

- 1 - Press **TV GUIDE**.
- 2 - Press the colour key **Recordings**.
- 3 - At the top of the screen, select **Scheduled** and press **OK**.
- 4 - In the list of scheduled recordings and reminders, select the tab **Recordings** and press **OK** to view the scheduled recordings only.
- 5 - Select the scheduled recording that conflicts with another scheduled recording and press the colour key **Adjust Time**.
- 6 - Select the start or end time and change the time with the **▲** (up) or **▼** (down) keys. Select **Apply** and press **OK**.
- 7 - Press **← BACK** to close the menu.

Auto End Margin

You can set the time margin that the TV will add automatically at the end of each scheduled recording.

To set the automatic end time margin...

- 1 - Press **TV GUIDE**.
- 2 - Press **OPTIONS** and select **Auto End Margin** and press **OK**.
- 3 - Press **▲** (up) or **▼** (down) and press **OK** to set the time margin added to a recording automatically. You can add up to 45 minutes to a recording.
- 4 - Press **← BACK** to close the menu.

Manual Recording

You can schedule a recording that is not linked to a TV programme. You set the tuner type, channel and the start and end time yourself.

To schedule a recording manually...

- 1 - Press **TV GUIDE**.
- 2 - Press the colour key **Recordings**.
- 3 - At the top of the screen, select **Scheduled** and press **OK**.
- 4 - Press **OPTIONS**, select **Schedule** and press **OK**.
- 5 - Select the tuner from where you want to record and press **OK**.
- 6 - Select the channel to record from and press **OK**.
- 7 - Select the day of the recording and press **OK**.
- 8 - Set the start and end time of the recording. Select a button and use the **▲** (up) or **▼** (down) keys to set the hours and minutes.
- 9 - Select **Schedule** and press **OK** to schedule the manual recording.

The recording will appear in the list of scheduled recordings and reminders.

Watch a Recording

To watch a recording...

- 1 - Press **TV GUIDE**.
- 2 - Press the colour key **Recordings**.
- 3 - In the list of recordings, select the recording you need and press **OK** to start watching.
- 4 - You can use the keys **||** (pause), **▶** (play), **◀◀** (rewind), **▶▶** (fast forward) or **■** (stop).
- 5 - To switch back to watch TV, press **TV EXIT**.

9.2

Pause TV

What You Need

You can pause a digital TV broadcast and resume watching it a bit later.

To pause a TV programme you need...

- a connected USB Hard Drive formatted on this TV
- digital TV channels installed on this TV
- to receive channel information for the on screen TV Guide

With the USB Hard Drive connected and formatted, the TV continuously stores the TV broadcast you are watching. When you switch to another channel, the broadcast of the former channel is cleared. Also when you switch the TV to standby the broadcast is cleared.

You cannot use Pause TV when you are recording.

For more information, in **Help**, press the colour key **Keywords** and look up **USB Hard Drive, installation**.

Pause a Programme

To pause and resume a broadcast...

To pause a broadcast, press **||** (Pause). A progress bar at the bottom of the screen appears briefly. To call up the progress bar, press **||** (Pause) again. To resume watching, press **▶** (Play).

With the progress bar on screen, press **◀◀** (Rewind) or press **▶▶** (Forward) to select from where you want to start viewing the paused broadcast. Press these keys repeatedly to change speed.

You can pause a broadcast for a maximum time span of 90 minutes.

To switch back to the live TV broadcast, press **■** (Stop).

Replay

Since the TV stores the broadcast you are watching, you can mostly replay the broadcast for a few seconds.

To replay a current broadcast...

1 - Press **⏸** (Pause)

2 - Press **⏮** (Rewind). You can press **⏮** repeatedly to select from where you want to start viewing the paused broadcast. Press these keys repeatedly to change speed. At one point you will reach the start of the broadcast storage or the maximum time span.

3 - Press **▶** (Play) to watch the broadcast again.

4 - Press **■** (Stop) to watch the broadcast live.

Top Picks

10.1

About Top Picks



With  TOP PICKS your TV recommends current TV programmes, the latest rental videos and Online TV services for you to watch. Make sure you agree to the Terms of Use. To enjoy Top Picks connect your TV to the Internet.

The Top Picks information and services are only available in selected countries.

Terms of Use

To allow the TV to make these recommendations, you must agree to the Terms of Use. To get personalised recommendations based on your viewing habits, make sure you checked the tick box for **Personal Recommendations Consent**.

To agree to the Terms of Use and agree to the Personal Recommendations Consent...

- 1 - Press  TOP PICKS.
- 2 - Press  OPTIONS, select **Terms of Use** and press **OK**.
- 3 - Select (... ..) and press **OK**.
- 4 - Press  BACK.

10.2

Now on TV

About Now on TV

With  Now on TV , the TV recommends the 10 most popular programmes to watch at this moment.

The TV recommends programmes on TV now or starting within 15 minutes. The recommended programmes are selected from the channels you installed. The selection is made from channels of your country. Also, you can let **Now on TV** do some personalised recommendations for you, based on programmes you watch regularly.

To make the Now on TV information available...

- the Now on TV information must be available in your country.
- the TV must have channels installed.
- the TV must be connected to the Internet.
- the TV Clock must be set to Automatic or Country Dependent.
- you must accept the Terms of Use (You might have accepted already when you connected to the Internet.).



The icon  will only appear at the top of the screen

when Now on TV is available.

The TV does not store former recommendations.

Using Now on TV

To open Now on TV...

- 1 - Press  TOP PICKS to open the Top Picks menu.
- 2 - Select  Now on TV at the top of the screen and press **OK**.
- 3 - Press  BACK to close.

When you open **Now on TV**, the TV may need a few seconds to refresh the page information.

In Now on TV you can...

- select and press **OK** on a programme icon to tune to the ongoing programme.
- select and press **OK** on a scheduled programme icon to tune to the channel already.

You can use the colour keys on the remote control to start, stop or clear a scheduled recording. You can also set or remove a reminder that warns you when a programme starts.

To leave Now on TV without tuning to another channel, press  BACK.

10.3

TV on Demand

About TV on Demand



With  TV on Demand , you can watch TV programmes you missed or watch your favourite programmes whenever it suits you best. This service is also called Catch Up TV, Replay TV or Online TV. Programmes available on TV on Demand are free to watch.

You can let TV on Demand do some personalised recommendations of programmes, based on the TV installation and the programmes you watch regularly.

The icon  will only appear at the top of the screen when TV on Demand is available.

Using TV on Demand

To open TV on Demand...

- 1 - Press  TOP PICKS to open the Top Picks menu.
- 2 - Select  TV on Demand at the top of the screen and press **OK**.
- 3 - Press  (down) to open the page full screen.
- 4 - You can select a specific broadcaster if more than

one is available.

5 - Select a programme icon and press **OK** to start watching.

6 - Press **←** **BACK** to close.

When you open **TV on Demand**, the TV may need a few seconds to refresh the page information.

Once a programme started, you can use the **▶** (Play) and **⏸** (Pause) keys.

4 - Make the payment on TV.

5 - Start watching. You can use the **▶** (Play) and **⏸** (Pause) keys.

10.4

Video on Demand

About Video on Demand

With  **Video on Demand**, you can rent movies from an online rental video store.

You can let Video on Demand do some personalised recommendations of movies, based on your country, the TV installation and the programmes you watch regularly.

The icon  will only appear at the top of the screen when Video on Demand is available.

Payment

When you rent or buy a movie, you can pay the video store securely with your credit card. Most video stores ask you to create a login account the first time you rent a movie.

Internet Traffic

Streaming a lot of videos may cause you to exceed your monthly Internet traffic limit.

Using Video on Demand

To open Video on Demand...

1 - Press  **TOP PICKS** to open the Top Picks menu.

2 - Select  **Video on Demand** at the top of the screen and press **OK**.

3 - Use the navigation keys to select a movie poster.

4 - Press **←** **BACK** to close.

When you open **Video on Demand**, the TV may need a few seconds to refresh the page information.

You can select a specific video store if more than one is available.

To rent a movie...

1 - Navigate the highlight on a movie poster. Limited info will show after some seconds.

2 - Press **OK** to open the movie page of the video store for a synopsis of the movie.

3 - Confirm your order.

Home Menu

11.1

About the Home Menu

To enjoy the benefits of your Android TV, connect the TV to the Internet.

Like on your Android smartphone or tablet, the Home menu is the centre of your TV. From the Home menu you can start any application, switch to a TV channel, rent a movie, open a website or switch to a connected device. Depending on your TV setup and your country the Home menu can contain different items.

The Home menu is organised in rows...

Recommendations

The first row suggests popular videos, music videos or Internet hits. You can set the Privacy settings in Terms of Use to allow suggestions based on your personal viewing habits.

Philips Collection

This row contains suggestions from Apps.

Apps

The row of Apps contain all Apps that come with the TV and the Apps you download from the Google Play store yourself. In this row you will also find the Apps for TV, like **Watch TV**, **Sources**, **Media** and others. Apps you started recently will appear in front of the row.

Games

From here, you can start a game on TV. If you download a game, it will appear in this row.

Settings



From here, you can open a selection of settings. However, to find all settings, press  **SETTINGS** and select **All Settings**. You can also open **Help** here.

See also www.support.google.com/androidtv

11.2

Open the Home Menu

To open the Home menu and open an item...

- 1 - Press  **HOME**.
- 2 - Select an item and press **OK** to open or start it.
- 3 - Press  **BACK** to close the Home menu without starting anything.

Search and Voice Search

You can search for videos, music or anything else on the Internet with the  icon in the Home menu. You can use the speak out or type what you are looking for.

For more information, in **Help**, press the colour key  **Keywords** and look up **Voice Search** for more information.

11.4

Restricted Profile

You can restrict the use of certain apps by switching the TV to a restricted profile. This restricted profile will only allow the use of apps which you have selected. You can only switch out of this profile with a PIN code.

With the TV switched to a restricted profile you cannot...

- Find or open apps which are marked as Not allowed
- Access the Google Play Store
- Purchase through Google Play Movies & TV, nor Google Play Games
- Use third-party apps that don't use the Google sign-in

With the TV switched to a restricted profile you can...

- Watch content already rented or purchased from Google Play Movies & TV
- Play games already purchased and installed from Google Play Games
- Access the following settings: Wi-Fi network, Speech and Accessibility
- Add Bluetooth accessories

The Google Account on TV will stay logged in. Using a restricted profile doesn't change the Google Account.

TV Menu



About TV Menu

If the TV cannot be connected with the Internet, you can use the **TV Menu** as your Home menu.

In the TV Menu, you will find every TV function.

Open TV Menu

To open TV Menu and open an item...

- 1 - Press  to open TV Menu.
- 2 - Select an item and press **OK** to open or start it.
- 3 - Press  **BACK** to close TV Menu without starting anything.

Netflix

If you have a Netflix membership subscription, you can enjoy Netflix on this TV. Your TV must be connected to the Internet.

To open Netflix, press **NETFLIX** to open the Netflix App. You can open Netflix immediately from a TV in standby.

www.netflix.com

FreeviewPlus

FreeviewPlus* is a new television service which provides a state of the art EPG and seamless access to Catch Up TV from free-to-air networks with the simple press of a button. FreeviewPlus provides an unrivalled user experience and places free to air television at the forefront of innovation, with services that include:

- A 7-day, easy-to-use EPG
- All available Catch Up TV on the TV screen
- Featured recommendations
- Ability to browse by genre and search programs for the next 7 days
- A Favourites function with reminders for live and Catch Up programs

What You Need

- you need a high-speed (broadband) Internet connection to the TV

To launch FreeviewPlus

When you are watching TV, you will briefly see a prompt at the top left of the screen.

- Press the colour key  on the remote control to launch FreeviewPlus.
- Follow the on-screen instructions and use the colour keys, arrow keys, and OK button to navigate.

*FreeviewPlus uses HbbTV technology which combines broadcast and broadband. Internet connection is required. Data usage charges and conditions apply.

Find more information on www.freeview.com.au



Sources

15.1

Switch to a device

From the list of Sources, you can switch to any of the connected devices. You can switch to a tuner to watch TV, open the content of a connected USB Flash Drive or see the recordings you made on a connected USB Hard Drive. You can switch to your connected devices to watch their programme, a digital receiver or a Blu-ray Disc player.

To switch to a connected device...

- 1 - Press  SOURCES to open the Sources menu.
- 2 - Select one of the item in the source list and press **OK**. The TV will show the programme or content of the device.
- 3 - Press  SOURCES again to close the menu.

One Touch Play

With the TV in standby, you can switch on a disc player with your TV remote control.



To switch on both disc player and TV from standby and start playing the disc immediately, press  (play) on the TV remote control. The device must be connected with an HDMI cable and both TV and device must have HDMI CEC switched on.

15.2

Options for a TV Input

Some TV input devices offer specific settings.

To set the options for a specific TV input...

- 1 - Press  SOURCES.
- 2 - Select the TV input in the list and press **OK**.
- 3 - Press  OPTIONS. You can set the options for the selected TV input here.
- 4 - Press  OPTIONS again to close the Options menu.

Possible options...

Controls

With this option you can operate the connected device with the TV remote control. The device must be connected with an HDMI cable and both TV and device must have HDMI CEC switched on.

Device Info

Open this option to view information on the connected device.

Device Name and Type





When you connect a new device to the TV and the TV detects the device, you can assign an icon that fits the device type. If you connect a device with an HDMI cable and HDMI CEC, the TV detects the device type automatically and the device gets an appropriate icon.

The device type determines picture and sound styles, resolution values, specific settings or the position within the Sources menu. You don't have to worry about the ideal settings.

Rename or Change Type





You can always change the name or change the type of a connected device. Look for the  icon at the right of the device name in the Sources menu. Some TV input sources do not allow a name change.

To change the device type...

- 1 - Select the device in the Sources menu.
- 2 - Press  (right) to select the  icon and press **OK**.
- 3 - Press  **BACK** to hide the onscreen keyboard.
- 4 - Press  (down) to find all available device types. Select the type you want and press **OK**.

- 5 - If you want to reset the type of the device to the original connector type, select **Reset** and press **OK**.
- 6 - Select **Close** and press **OK** to close this menu.

To change the device name...

- 1 - Select the device in the Sources menu.
- 2 - Press  (right) to select the  icon and press **OK**.
- 3 - Use the on-screen Keyboard to delete the current name and enter a new one. Press  to confirm.
- 4 - Press  **BACK** to hide the on-screen keyboard.
- 5 - If you want to reset the name of the device to the original connector name, select **Reset** and press **OK**.
- 6 - Select **Close** and press **OK** to close this menu.

Game or Computer

The device type determines picture and sound styles, resolution values and other specifics. You don't have to worry about the ideal settings.

For some devices the type of the device is not that clear. A game console can have a built-in Blu-ray Disc player and the type is set to Player because it is used as a disc player most of the time. For this kind of devices, you can temporarily switch to the ideal settings for gaming. Or alternatively, switch to the

ideal settings for a connected computer.

You can only use the setting **Game or Computer** when you switch to a connected device in the Sources menu. The Game or Computer setting is stored for the selected device.

To switch to the ideal settings for gaming or computer manually...

- 1 - Press  **SETTINGS**, select **All Settings** and press **OK**.
- 2 - Select **Picture > Advanced** and press **OK**.
- 3 - Select **Game, Computer or Off**.
- 4 - Press **<** (left) to go back one step or press **<** **BACK** to close the menu.



Remember to set this setting back to **Off** when you stop playing the game.

15.5

Rescan Connections

You can rescan all TV connections to update the Sources menu with recently connected devices.

To rescan the connections...

- 1 - Press  **SOURCES** to open the Sources menu.
- 2 - Press **^** (up) to select the  icon at the top right of the Sources menu.
- 3 - Press **OK** to start scanning the connections. Newly connected devices will be added to the Sources menu.

Apps

16.1

About Apps

You can find all installed apps in the **Apps** section of the Home menu.

Like apps on your smartphone or tablet, the apps on your TV offer specific functions for an enriched TV experience. Apps like YouTube, games, video stores or weather forecasts (a.o.). You can use the Internet app to surf the Internet.

Apps can come from the **Philips App Gallery** or the **Google Play™ Store**. To get you started, some practical apps are pre-installed on your TV.

To install apps from the Philips App Gallery or the Google Play Store, the TV must be connected to the Internet. You must agree to the Terms of Use to use apps from the App Gallery. You must sign in with a Google Account to use the Google Play apps and Google Play Store.

For more information, in **Help**, press the colour key **Keywords** and look up **App Gallery**, **Terms of Use** or **App Gallery**, **Privacy Settings** for more information.

16.2

Google Play

Movies and TV

With **Google Play Movies & TV**, you can rent or buy movies and TV shows to watch on TV.

What You Need

- your TV must be connected with the Internet
- you must sign in with your Google Account on TV
- add a credit card to your Google Account to purchase movies and TV shows

To rent or buy a movie or TV show...

- 1 - Press **HOME**.
- 2 - Scroll down and select **Apps** > **Google Play Movies & TV** and press **OK**.
- 3 - Select a movie or TV show and press **OK**.
- 4 - Select the purchase you want and press **OK**. You will be taken through the purchase procedure.
- 5 - Alternatively, press **▶** (right) and select **Add to wishlist** and press **OK**. This video will be added to **My wishlist**.

To watch a rented or bought movie or TV show...

- 1 - Press **HOME**.
- 2 - Scroll down and select **Apps** > **Google Play**

Movies & TV and press **OK**.

3 - Select **My library** and select **My Movies** or **My TV Shows** and press **OK**.

4 - Select what you want to watch and press **OK**. You can use the **■** (stop), **||** (pause), **◀** (rewind) or **▶** (fast forward) keys on the remote control.

5 - To stop the **Movies & TV** app, press **← BACK** repeatedly or press **TV EXIT**.

Some Google Play products and features aren't available in all countries.

Find more information on support.google.com/androidtv

Music

With **Google Play Music**, you can play your favourite music on TV.

With **Google Play Music** you can buy new music on your computer or mobile device. Or, on your TV, you can sign up for **All Access**, the **Google Play Music** subscription. Alternatively, you can play the music you already own, stored on your computer.

What You Need

- your TV must be connected with the Internet
- you must sign in with your Google Account on TV
- add a credit card to your Google Account to take a music subscription

To start **Google Play Music**...

- 1 - Press **HOME**.
- 2 - Scroll down and select **Apps** > **Google Play Music** and press **OK**.
- 3 - Select the music you want and press **OK**.
- 4 - To stop the **Music** app, press **← BACK** repeatedly or press **TV EXIT**.

Some Google Play products and features aren't available in all countries.

Find more information on support.google.com/androidtv

Games

With **Google Play Games**, you can play games on TV. Online or offline.

You can see what your friends are playing currently or you can join the game and compete. You can track your achievements or start wherever you left off.





What You Need

- your TV must be connected with the Internet
- you must sign in with your Google Account on TV
- add a credit card to your Google Account to purchase new games

Start the **Google Play Games** app to select and install

new game apps on your TV. Some games are free of charge. A message appears if a particular game needs a gamepad to play the game.

To start or stop a Google Play Game...

- 1 - Press  HOME.
- 2 - Scroll down and select  Apps > **Google Play Games** and press OK.
- 3 - Select a game to play or select a new game to install and press OK.
- 4 - When done, press  BACK repeatedly or press  EXIT or stop the app with its dedicated exit/stop button.

The games you install will also appear in the row of  Games in the Home menu

Some Google Play products and features aren't available in all countries.

Find more information on support.google.com/androidtv



Google Play Store

From the Google Play Store you can download and install new apps. Some apps are free of charge.

What You Need

- your TV must be connected with the Internet
- you must sign in with your Google Account on TV
- add a credit card to your Google Account to purchase apps





To install a new app...

- 1 - Press  HOME.
- 2 - Scroll down and select  Apps > **Google Play Store** and press OK.
- 3 - Select the app you want to install and press OK.
- 4 - To close the **Google Play Store**, press  BACK repeatedly or press  EXIT.

Content Filtering (Parental controls)

In the Google Play Store, you can hide apps according to users/buyers maturity. You need to enter a PIN code to select or change the level of maturity.

To set the parental control...

- 1 - Press  HOME.
- 2 - Scroll down and select  Apps > **Google Play Store** and press OK.
- 3 - Select **Settings** > **Content Filtering** and press OK.
- 4 - Select the level of maturity you want.
- 5 - On request, enter the PIN code.
- 6 - To close the **Google Play Store**, press  BACK repeatedly or press  EXIT.

Some Google Play products and features aren't available in all countries.

Find more information on support.google.com/androidtv

Payments

To make a payment on Google Play on TV, you must add a form of payment - a credit card (outside the United States) - to your Google Account. When you purchase a movie or TV show, you will be charged on this credit card.

To add a credit card ...

- 1 - On your computer, go to accounts.google.com and sign in with the Google Account you will use with Google Play on TV.
- 2 - Go to wallet.google.com to add a card to your Google Account.
- 3 - Enter your credit card data and accept the terms and conditions.

16.3



App Gallery

Connect the TV to the Internet to enjoy apps selected by Philips. These apps are made specially for TV. The **Philips App Gallery** offers a wide diversity of apps. For some countries, you can install apps of a local Videostore or apps from TV broadcasters in your country. The latter can offer Catch-Up TV services. Downloading and installing App Gallery apps is free of charge.

The Philips App Gallery collection of apps can differ per country or region.

Some App Gallery apps are pre-installed on your TV. To install other apps from the App Gallery, you will be asked to agree to the Terms of Use. You can set the Privacy Settings according to your preference.

To install an app from the App Gallery...





- 1 - Press  HOME.
- 2 - Scroll down and select  Philips Collection >  App Gallery and press OK.
- 3 - Select an app icon and press OK.
- 4 - Select **Install** and press OK.

16.4

Start or Stop an App

You can start an app from the Home menu.

To start an app...

- 1 - Press  HOME.
- 2 - Scroll down to  Apps and select the app you want and press OK.
- 3 - To stop an app, press  BACK or press  EXIT or stop the app with its dedicated exit/stop button.

Lock Apps

About App Locks

You can lock apps unsuited for children. You can lock 18+ rated apps from the App Gallery or set up a restricted profile in the Home menu.

18+

The 18+ app lock will ask for a PIN code when you try to start an 18+ rated app. This lock is only valid for 18+ rated apps from the Philips App Gallery.

Restricted profile

You can set up a restricted profile for the Home menu where only the apps you allow are available. You need to enter a PIN code to set up and switch on the restricted profile.

Google Play Store - Maturity

In the Google Play Store, you can hide apps according to users/buyers maturity. You need to enter a PIN code to select or change the level of maturity. The level of maturity will determine which apps are available for installation.

For more information, in **Help**, press the colour key **— Keywords** and look up **Google Play Store** for more information.

Lock 18+ rated apps

You can lock 18+ rated apps from the Philips App Gallery. This setting controls the 18+ setting in the Philips App Gallery Privacy Settings.

To lock 18+ rated apps...

- 1 - Press **⚙**, select **All Settings** and press **OK**.
- 2 - Select **Child Lock**, select **App Lock** and press **OK**.
- 3 - Select **On** and press **OK**.
- 4 - Press **←** (left) repeatedly if necessary, to close the menu.

For more information, in **Help**, press the colour key **— Keywords** and look up **Child Lock, Set PIN code** for more information.

Restricted Profile

About Restricted Profile

You can restrict the use of certain apps by switching the TV to a restricted profile. The Home menu will only show the apps you allowed. You need a PIN code to switch out of the restricted profile.

With the TV switched to a restricted profile you

cannot...

- Find or open apps which are marked as Not allowed
- Access the Google Play Store
- Purchase through Google Play Movies & TV, nor Google Play Games
- Use third-party apps that don't use the Google sign-in

With the TV switched to a restricted profile you can...

- Watch content already rented or purchased from Google Play Movies & TV
- Play games already purchased and installed from Google Play Games
- Access the following settings: Wi-Fi network, Speech and Accessibility
- Add Bluetooth accessories

The Google Account on TV will stay logged in. Using a restricted profile doesn't change the Google Account.

Set Up

To set up the restricted profile...

- 1 - Press **⚙**, select **All Settings** and press **OK**.
- 2 - Select **Android Settings** and press **OK**.
- 3 - Press **▼** (down) and select **Personal > Security & restrictions** and press **OK**.
- 4 - Select **Restricted Profile** and press **OK**.
- 5 - Select **Settings** and press **OK**.
- 6 - Enter a PIN code with the remote control.
- 7 - Select **Allowed apps** and press **OK**.
- 8 - In the list of available apps, select an app and press **OK** to allow or not allow this app.
- 9 - Press **← BACK** to go back one step or press **TV EXIT** to close the menu.

Now you can enter the restricted profile.

With the PIN code, you can always change the PIN code or edit the list of allowed or not allowed apps.

Enter



To enter (switch to) the restricted profile...

- 1 - Press **⚙**, select **All Settings** and press **OK**.
- 2 - Select **Android Settings** and press **OK**.
- 3 - Press **▼** (down) and select **Personal > Security & restrictions** and press **OK**.
- 4 - Select **Enter restricted profile** and press **OK**.
- 5 - Enter a PIN code with the remote control.
- 6 - Press **← BACK** to go back one step or press **TV EXIT** to close the menu.

You can see when a restricted profile is entered if an icon appears in the Home screen. Scroll down to **⚙ Settings** and scroll to the far right.

Exit

To exit the restricted profile...

- 1 - Press  HOME, scroll down to  Settings and scroll far right.
- 2 - Select **Restricted Profile** and press **OK**.
- 3 - Select **Exit restricted profile** and press **OK**.
- 4 - Enter the PIN code. The TV will exit the restricted profile.



If you connect a USB Hard Drive, you can use the drive to extend the TV memory to store more apps. Allow the USB Hard Drive to be used as an additional TV memory during the formatting process. The TV will try to store new apps on the USB Hard Drive first. Some apps do not allow to be stored on a USB Hard Drive.

16.6

Manage Apps

If you stop an app and return to the Home menu, the app is not really stopped. The app is still running in the background to be readily available when you start it again. To run fluently, most apps need to save some data in the cache memory of the TV. It might be good to stop an app completely or clear the cache data of a particular app to optimise the overall performance of apps and to keep memory usage low on your Android TV. Also, it is best to uninstall apps that you are not using anymore.

To open the list of downloaded and system apps...

- 1 - Press , select **All Settings** and press **OK**.
- 2 - Select **Android Settings** and press **OK**.
- 3 - Select **Device > Apps** and press **OK**.
- 4 - Select an app and press **OK**. If the app is still running, you can force it to stop or you can clear the cache data. You can uninstall apps you downloaded.
- 5 - Press  BACK to go back one step or press  EXIT to close the menu.



If you are using a USB Hard Drive to store apps, you can move the app from the USB Hard Drive to the TV memory or vice versa.

16.7

Storage

You can see how much storage space - the internal TV memory - you are using for your apps, videos, music, etc. You can see how much free space you still have available for installing new apps. Check your storage if apps start to run slow or in case of app trouble.

To see how much storage you are using...

- 1 - Press , select **All Settings** and press **OK**.
- 2 - Select **Android Settings** and press **OK**.
- 3 - Select **Device > Storage & reset** and press **OK**.
- 4 - View the storage usage of the TV memory.
- 5 - Press  BACK to go back one step or press  EXIT to close the menu.

USB Hard Drive

Games

17.1

What You Need

On this TV, you can play games...

- from the App Gallery in the Home menu
- from the Google Play Store in the Home menu
- from a connected Game Console

Games from the App Gallery or the Google Play Store must be downloaded and installed on TV before you can play them. Some games need a gamepad to play.

To install game apps from the Philips App Gallery or the Google Play Store, the TV must be connected to the Internet. You must agree to the Terms of Use to use apps from the App Gallery. You must sign in with a Google Account to use the Google Play apps and Google Play Store.

For more information, in **Help**, press the colour key **— Keywords** and look up **App Gallery**, **Terms of Use** or **App Gallery**, **Privacy Settings** for more information.

For more information on connecting to the Internet, in **Help**, press the colour key **— Keywords** and look up **Network Installation**.

17.2

Gamepads

To play games from the Internet on this TV, you can connect a selected range of wireless Gamepads. The TV can support 2 connected Gamepads at a time. When you connect the Gamepad, you can use it immediately.





For more information on connecting a gamepad, in **Help**, press the colour key **— Keywords** and look up **Gamepad**, connect.

17.3

Play a Game



From the Home menu

To start a game from the Home menu...

- 1 - Press  HOME.
- 2 - Scroll down to  Games, select a game and press OK.
- 3 - Press  BACK repeatedly or press  EXIT or stop the app with its dedicated exit/stop button.

From a Game Console

To start a game from a Game Console...

- 1 - Switch on the Game Console.
- 2 - Press  SOURCES and select a game console or the name of the connection.
- 3 - Start the game.
- 4 - Press  BACK repeatedly or press  EXIT or stop the app with its dedicated exit/stop button.

For more information on connecting a Game Console, in **Help**, press the colour key **— Keywords** and look up **Game Console**, connect.

Internet





18.1

Start Internet

You can browse the Internet on your TV. You can view any Internet website but most of them are not prepared for a TV screen.

- Some plug-ins (e.g. to view pages or videos) are not available on your TV.
- You cannot send or download files.
- Internet pages are shown one page at a time and full screen.

To start the Internet browser...



- 1 - Press  HOME.
- 2 - Scroll down and select **Apps** >  **Internet** and press **OK**.
- 3 - Enter an Internet address and select , press **OK**.
- 4 - To close Internet, press  HOME or  EXIT.

18.2

Options on Internet

Some extras are available for the Internet.

To open the extras...

- 1 - With the website open, press  **OPTIONS**.
- 2 - Select one of the items and press **OK**.
- 3 - Press  (left) repeatedly if necessary, to close the menu.

Enter Address

To enter a new Internet address.

Show Favourites

To view the pages you marked as favourites.

Reload Page

To load the Internet page again.

Zoom Page

Use the slider bar to set the zoom percentage.

Security Info

To view the security level of the current page.

Mark as Favourite

To mark the current page as a favourite.

Subtitles

To select subtitles if available.

Videos, Photos and Music





19.1

From a USB Connection

You can view your photos or play your music and videos from a connected USB flash drive or USB Hard Drive.

With the TV switched on, plug in a USB flash drive or a USB Hard Drive to one of the USB connections. The TV detects the device and will list your media files.

If the list of files does not appear automatically...

- 1 - Press  SOURCES, select  USB and press OK.
- 2 - Select  USB Devices and press  (right) to select the USB device you need.
- 3 - You can browse your files in the folder structure you have organised on the drive.
- 4 - To stop playing videos, photos and music, press  EXIT.

Warning

If you try to pause or record a programme with a USB Hard Drive connected, the TV will ask you to format the USB Hard Drive. This formatting will delete all current files on the USB Hard Drive.

19.2

From a Computer or NAS





You can view your photos or play your music and videos from a computer or a NAS (Network Attached Storage) in your home network.

The TV and computer or NAS must be in the same home network. On your computer or NAS, you need to install Media Server Software. Your Media Server must be set to share your files with the TV. The TV shows your files and folders as they are organised by the Media Server or as they are structured on your computer or NAS.

The TV does not support subtitles on video streams from a computer or NAS.

If the Media Server supports searching for files, a search field is available.

To browse and play the files on your computer...

- 1 - Press  SOURCES, select  Network and press OK.
- 2 - Select  SimplyShare Devices and press  (right) to select the device you need.





- 3 - You can browse and play your files.
- 4 - To stop playing videos, photos and music, press  EXIT.

19.3

From a Cloud Storage Service

You can view photos or play music and videos you uploaded on a storage service in the online cloud*.

With the  Cloud Explorer app you can connect to Cloud Hosting Services. You can use your login and password to connect.

- 1 - Press  HOME.
- 2 - Scroll down and select  Apps >  Cloud Explorer and press OK.
- 3 - Select the hosting service you need.
- 4 - Connect and sign in to the hosting service with your login and password.
- 5 - Select the photo or video you want to play and press OK.
- 6 - Press  (left) to go back one step or press  BACK to close the menu.

* A storage service like Dropbox™.

19.4





Play your Videos

Play Videos

How you open the list of your media files on TV depends on the type of device where the files are stored. See the chapters above.

To play a video on TV...

Select  Videos, and select the file name and press OK.

- To pause the video, press OK. Press OK again to continue.
- To rewind or go fast forward, press  or . Press the keys several times to speed up - 2x, 4x, 8x, 16x, 32x.
- To jump to the next video in a folder, press OK to pause and select  on screen and press OK.
- To stop the video playback, press  (Stop).
- To go back to the folder, press  BACK.

Progress Bar

To show the progress bar when a video is playing (playhead position, duration, title, date, etc.), press  INFO. Press again to hide the info.

Video Options

During the video playback, press  **OPTIONS** to...

- **Mark as Favourite** – Set the selected video as favourite.
- **Play All** – Play all video files in this folder.
- **Play One** – Play this video only.

- **Subtitles** – If available, you can switch subtitles **On**, **Off** or **On During Mute**.
- **Audio Language** – If available, select an Audio Language.
- **Shuffle** – Play your files in a random order.
- **Repeat** – Plays all videos in this folder once or continuously.

19.5

View your Photos

View Photos

How you open the list of your media files on TV depends on the type of device where the files are stored. See the chapters above.

To view all photos on TV...

Select  **Photos** , and select **All** and press **OK**.

To view a photo on TV...

Select  **Photos** , and select the file name and press **OK**.

To start a slide show on TV...

If there are several photos in a folder, you can start a slide show.

To start a slide show...

- 1 - Select the folder with photos.
 - 2 - Press the colour key  **Slide Show** .
- To jump to the next or previous photo, press **>** (right - next) or **<** (left - previous).
 - To pause the slide show, press **OK**. To start again, press **OK** again.
 - To stop the slide show, press **OK** and press **<** **BACK**.

Info

To view info on a photo (size, creation date, file path, etc.), select a photo and press  **INFO**. Press again to hide the info.

Slideshow with Music

You can watch a slideshow of your photos and listen to your music at the same time. You must start the music before you start the photo slideshow.

To play music with the slide show...



- 1 - Select a song or a folder with songs and press **OK**.
- 2 - Press  **INFO** to hide file info and progress bar.
- 3 - Press **<** **BACK**.
- 4 - Now use the navigation arrows to select the folder with photos.
- 5 - Select the folder with photos and press  **Slide Show**.
- 6 - To stop the slideshow, press **<** **BACK**.

Photo Options

With a photo on screen, press  **OPTIONS** to...

- **Mark as Favourite** – Set the selected photo as favourite.
- **Slide Show** – Show photos one after the other.

- **Rotate** – Rotate the photo to landscape or portrait format.
- **Shuffle** – Play your files in a random order.
- **Repeat** – Play the slide show once or continuously.

- **Stop Music** – Stop the music playing in the background.
- **Slide Show Speed** – Set the speed of the slide show.
- **Slide Show Transition** – Set the style of the photo transitions.

19.6

Play your Music

Play Music

How you open the list of your media files on TV depends on the type of device where the files are stored. See the chapters above.

To play a song on TV...

Select  **Music** , and select the file name and press **OK**

If there are several songs in a folder, you can listen to them one after the other.

- To pause a song, press **OK**. Press **OK** again to continue.
- To rewind or go fast forward, press **>>** or **<<**. Press the keys several times to speed up - 2x, 4x, 8x, 16x, 32x.

- To jump to the next song in a folder, press **OK** to pause and select **▶** on screen and press **OK**.
- To go back to the folder, press **← BACK**, the music will keep on playing.
- To stop the music playback, press **■** (Stop).

Progress Bar

To show the progress bar when a song is playing (playhead position, duration, title, date, etc.), press **ⓘ INFO** .
Press again to hide the info.

Music Options

Options for playing music...

- **Mark as Favourite** – Set the selected song as favourite.
- **Play All** – Play all songs in this folder.
- **Play One** – Play this song only.

- **Shuffle** – Play your files in a random order.

- **Repeat** – Plays all songs in this folder once or continuously.

Smartphones and Tablets

20.1

Philips TV Remote App

The new Philips TV Remote App on your smartphone or tablet is your new TV buddy.

With the TV Remote App, you master your media around you. Send photos, music or videos to your big TV screen or watch any of your TV channels live on your tablet or phone. Look up what you want to watch on the TV Guide and watch it on your phone or TV. With the TV Remote App you can use your phone as a remote control.

Download the Philips TV Remote App from your favourite app store today.

The Philips TV Remote App is available for iOS and Android and is free of charge.

Wi-Fi Smart Screen

To watch digital TV channels on your smartphone or tablet with the Philips TV Remote App, you must switch on Wi-Fi Smart Screen. For more information, in **Help**, press the colour key  **Keywords** and look up **Wi-Fi Smart Screen**.

20.2

Google Cast

What You Need

If an app on your mobile device has Google Cast, you can cast your app on this TV. On the mobile app, look for the Google Cast icon. You can use your mobile device to control what's on TV. Google Cast works on Android and iOS.

Your mobile device must be connected to the same Wi-Fi home network as your TV.

Apps with Google Cast

New Google Cast apps come available every day. You can already try it with YouTube, Chrome, Netflix, Photowall ... or Big Web Quiz for Chromecast. See also google.com/cast

Some Google Play products and features aren't available in all countries.

Find more information on support.google.com/androidtv

Cast to Your TV

To cast an app to the TV screen...

- 1 - On your smartphone or tablet, open an app that supports Google Cast.
- 2 - Tab the Google Cast icon.
- 3 - Select the TV you would like to cast to.
- 4 - Press play on your smartphone or tablet. What you selected should start playing on TV.

20.3

Miracast

About Wi-Fi Miracast

You can view your photos or play your music and videos from a mobile device on your TV with Wi-Fi Miracast™. The mobile device and the TV should be within range, which usually means being in the same room.

Check if your mobile device is ready for Miracast.

Your TV is a **Wi-Fi CERTIFIED Miracast™** device. With Miracast™, you can watch and share the screen of your smartphone, tablet or computer on your TV screen wirelessly. You can stream videos (audio and video), share photos or anything else that's on screen of the device. No need to connect the device to your home network. Both the TV and the device must be Wi-Fi CERTIFIED Miracast™ devices and have Miracast switched on.

Miracast on this TV is subject to the HDCP protocol and cannot display copy-protected premium content sent by a device. The maximum video resolution supported is 720p for 2.4GHz Wi-Fi or 1080p for 5GHz Wi-Fi.

For more information on Wi-Fi CERTIFIED Miracast™ go to www.wi-fi.org

Wi-Fi®, the Wi-Fi CERTIFIED logo, the Wi-Fi logo are registered trademarks of the Wi-Fi Alliance. **Wi-Fi CERTIFIED Miracast™**, **Miracast™** are trademarks of the Wi-Fi Alliance.

Switch on Miracast

Make sure Wi-Fi Miracast is switched on.

- 1 - Press , select **All Settings** and press **OK**.
- 2 - Select **Wireless and Networks** and press **▶** (right) to enter the menu.
- 3 - Select **Wired or Wi-Fi > Wi-Fi Miracast** and press **OK**.
- 4 - Select **On** and press **OK**.
- 5 - Press **◀** (left) repeatedly if necessary, to close the menu.

Share a Screen on TV

To share the screen of your smartphone, tablet or computer on the TV...

- 1 - Switch on the TV.
- 2 - On the device, in the settings menu, set the device to cast or mirror its display. Miracast uses Wi-Fi Direct™.
- 3 - On the device scan for the available Miracast devices and select the TV to connect.
- 4 - On the TV, agree to the request to connect. You might be asked to enter a PIN code from the device on the TV - enter the numbers with the digit keys on the remote control. Alternatively, you might be asked to enter a PIN code on the device. If the connection is made, the TV will show the screen of the device.
- 5 - On the device, select the videos, photos or files you want to watch on TV.

* Miracast is supported by WiDi 3.5 onwards.

You might find the Wi-Fi connection (e.g. 'DIRECT_tvname') also in lists of available networks on other network devices, e.g. your laptop computer. However, this connection can only be used by Wi-Fi Miracast devices.

Stop Sharing

You can stop sharing a screen from the TV or from the mobile device.

From the device

With the application you use to start Miracast, you can disconnect and stop watching the screen of the device on TV. The TV will switch back to the last selected programme.

From the TV

To stop watching the screen of the device on TV, you can . . .

- press **TV** EXIT to watch a TV broadcast
- press **HOME** to start another activity on TV
- press **SOURCES** to open the Sources menu and select a connected device.

Block a Device

The first time you receive a request to connect from a device, you can block the device. The request from this device and all its requests in the future, will be ignored.

To block a device...

Select **Block...** and press **OK**.

Unblock all devices

All previously connected and also blocked devices are stored in the Wi-Fi Miracast list of connections. If you clear this list, all blocked devices will be unblocked.

To unblock all blocked devices...

- 1 - Press **⚙**, select **All Settings** and press **OK**.
- 2 - Select **Wireless and Networks > Wired or Wi-Fi** and press **OK**.
- 3 - Select **Wi-Fi Miracast Connections** and press **OK**. The list is cleared.
- 4 - Press **←** (left) repeatedly if necessary, to close the menu.

Blocking a previously connected device

If you want to block a device that you previously connected, you need to clear the Wi-Fi Miracast connections list first. If you clear this list, you will have to confirm or block the connection for every device again.

Screen Delay

The normal delay when sharing a screen with Miracast is about 1 second. The delay might be longer if you are using older devices with less processing power.

20.4

AirPlay

To add the AirPlay functionality to your Android TV, you can download and install one of the several Android apps that do just that. You can find several of these apps in the Google Play Store.

20.5

MHL

This TV is MHL™ compliant.

If your mobile device is also MHL compliant, you can connect your mobile device with a MHL cable to the TV. With the MHL cable connected you can share what's on your mobile device on the TV screen. Your mobile device charges its battery at the same time. The MHL connection is ideal for watching movies or playing games from your mobile device on TV for a longer time.

Charging

With the MHL cable connected, your device will charge while the TV is switched on (not in standby).

MHL Cable

You need a passive MHL cable (HDMI to Micro USB)

to connect your mobile device to the TV. You might need an extra adapter to connect to your mobile device. To connect the MHL cable to the TV use the HDMI 4 MHL connection.



MHL, Mobile High-Definition Link and the MHL Logo are trademarks or registered trademarks of the MHL, LLC.

Multi View

About Multi View

The Multi View screen cannot display video in 3D or in Ultra HD. Multi View is not available for analogue TV channels. Not all Apps support Multi View.

Text and TV

You can watch a TV channel in the small screen of Multi View when you're watching Text.

To watch a TV channel while watching Text...



- 1 - Press  MULTI VIEW .
- 2 - Select **Multi View: On** on screen. The channel you were watching appears in the small screen.

To hide the small screen, press  MULTI VIEW again and select **Multi View: Off** on screen.

Nettv and TV

You can watch a TV channel in the small screen of Multi View when you're watching a Nettv app in App Gallery.

To watch a TV channel while watching a Nettv app in App Gallery*...

- 1 - Press  MULTI VIEW .
- 2 - Select **Multi View: On** on screen. The channel you were watching appears in the small screen.
- 3 - Press  + or  - to switch channels in the small screen

To hide the small screen, press  MULTI VIEW again and select **Multi View: Off** on screen.

* Not every Nettv app can support Multi View with a TV channel, if the app cannot support Multi View, then TV will show a message: **Multi View is not supported**.

HDMI and TV

You can watch a TV channel in the small screen of Multi View when you're watching video from a connected HDMI device.

To watch a TV channel while watching video from connected HDMI device*...

- 1 - Press  MULTI VIEW .

2 - Select **Multi View: On** on screen. The channel you were watching appears in the small screen.

To hide the small screen, press  MULTI VIEW again and select **Multi View: Off** on screen.
 * You can only watch TV channel image in Multi view mode, the audio of TV channel will be mute.

Settings



22.1

Picture

Picture Style

Select a Style

For easy picture adjustment, you can select a preset Picture Style.

- 1 - While watching a TV channel, press .
- 2 - Select **Picture Style**, and select one of the styles in the list.
- 3 - Press  (left) repeatedly if necessary, to close the menu.

The available styles are...

- **Personal** - The picture preferences you set during the first start up.
- **Vivid** - Ideal for daylight viewing
- **Natural** - Natural picture settings
- **Standard** - Most energy conscious setting - Factory setting
- **Movie** - Ideal for watching movies

- **Photo** - Ideal for viewing photos

Customise a Style



Any picture setting you adjust, like Colour or Contrast, is stored in the currently selected **Picture Style**. It allows you to customise each style. Only the style **Personal** can save its settings for each connected device in the Sources menu.

Restore a Style

With a Picture Style selected, you can adjust any picture setting in **All Settings > Picture...**

The selected style will store the changes you made. We recommend to adjust the picture settings for the style **Personal** only. The Picture Style - Personal can save its settings for each individual connected device in Sources menu.

To restore the style to its original setting...



- 1 - While watching a TV channel, press .
- 2 - Select **Picture Style**, and select the Picture Style you want to restore.
- 3 - Press the colour key  **Restore Style**, and press OK. The style is restored.
- 4 - Press  (left) repeatedly if necessary, to close

the menu.

Home or Shop

If the **Picture Style** is switched back to **Vivid** every time you switch on the TV, the TV location is set to **Shop**. A setting meant for in-store promotion.

To set the TV for Home use...







- 1 - Press , select **All Settings** and press **OK**.
- 2 - Select **General Settings** and press  (right) to enter the menu.
- 3 - Select **Location > Home** and press **OK**.
- 4 - Press  (left) repeatedly if necessary, to close the menu.

Picture Settings

Colour

With **Colour**, you can adjust the colour saturation of the picture.







To adjust the colour...

- 1 - Press , select **All Settings** and press **OK**.
- 2 - Select **Picture** and press  (right) to enter the menu.
- 3 - Select **Colour** and press  (right).
- 4 - Press the arrows  (up) or  (down) to adjust the value.
- 5 - Press  (left) repeatedly if necessary, to close the menu.

Contrast

With **Contrast**, you can adjust the contrast of the picture.

To adjust the contrast...

- 1 - Press , select **All Settings** and press **OK**.
- 2 - Select **Picture** and press  (right) to enter the menu.
- 3 - Select **Contrast** and press  (right).
- 4 - Press the arrows  (up) or  (down) to adjust the value.
- 5 - Press  (left) repeatedly if necessary, to close the menu.

Sharpness

With **Sharpness**, you can adjust the level of sharpness in fine detail of the picture.

To adjust the sharpness...

- 1 - Press , select **All Settings** and press **OK**.
- 2 - Select **Picture** and press  (right) to enter the

menu.

- 3 - Select **Sharpness** and press **➤** (right).
- 4 - Press the arrows **▲** (up) or **▼** (down) to adjust the value.
- 5 - Press **◀** (left) repeatedly if necessary, to close the menu.

Advanced Picture Settings

Game or Computer

When you connect a device, the TV recognizes its type and gives each device a correct type name. You can change the type name if you wish. If a correct type name for a device is set, the TV automatically switches to the ideal TV settings when you switch to this device in the Sources menu.

If you have a game console with a built-in Blu-ray Disc player, you might have set the type name to Blu-ray Disc. With **Game or Computer** you can switch to the ideal settings for gaming manually. Don't forget to switch the Game or Computer setting off, when you return to watch TV.

To switch the setting manually...

- 1 - Press **⚙**, select **All Settings** and press **OK**.
- 2 - Select **Picture** and press **➤** (right) to enter the menu.
- 3 - Select **Advanced > Game or Computer**, and select the device type you want to use. To switch back to TV, select **Off**.
- 4 - Press **◀** (left) repeatedly if necessary, to close the menu.

Colour Settings

Colour Enhancement

With **Colour Enhancement**, you can enhance the colour intensity and the details in bright colours.

To adjust the level...

- 1 - Press **⚙**, select **All Settings** and press **OK**.
- 2 - Select **Picture** and press **➤** (right) to enter the menu.
- 3 - Select **Advanced > Colour > Colour Enhancement** and press **OK**.
- 4 - Select **Maximum, Medium, Minimum** or **Off**.
- 5 - Press **◀** (left) repeatedly if necessary, to close the menu.

Colour Temperature

With **Colour Temperature**, you can set the picture to a preset colour temperature or select **Custom** to set a temperature setting yourself with **Custom Colour**

Temperature. **Colour Temperature** and **Custom Colour Temperature** are settings intended for expert users.

To select a preset...

- 1 - Press **⚙**, select **All Settings** and press **OK**.
- 2 - Select **Picture** and press **➤** (right) to enter the menu.
- 3 - Select **Advanced > Colour > Colour Temperature** and press **OK**.
- 4 - Select **Normal, Warm** or **Cool**. Or select **Custom** if you want to customise a colour temperature yourself.
- 5 - Press **◀** (left) repeatedly if necessary, to close the menu.

Custom Colour Temperature

With **Custom Colour Temperature**, you can set a colour temperature yourself. To set a custom colour temperature, first select **Custom** in the **Colour Temperature** menu. **Custom Colour Temperature** is a setting intended for expert users.

To set a custom colour temperature...

- 1 - Press **⚙**, select **All Settings** and press **OK**.
- 2 - Select **Picture** and press **➤** (right) to enter the menu.
- 3 - Select **Advanced > Colour > Custom Colour Temperature** and press **OK**.
- 4 - Press the arrows **▲** (up) or **▼** (down) to adjust the value. WP is white point and BL is black level. You can also select one of the presets in this menu.
- 5 - Press **◀** (left) repeatedly if necessary, to close the menu.

Contrast Settings

Contrast Modes

With **Contrast Mode**, you can set the level at which power consumption can be reduced by dimming the intensity of the screen. Choose for the best power consumption or for the picture with the best intensity.

To adjust the level...

- 1 - Press **⚙**, select **All Settings** and press **OK**.
- 2 - Select **Picture** and press **➤** (right) to enter the menu.
- 3 - Select **Advanced > Contrast > Contrast Mode** and press **OK**.
- 4 - Select **Standard, Best Power, Best Picture**, or **Off**.
- 5 - Press **◀** (left) repeatedly if necessary, to close the menu.

Dynamic Contrast

With **Dynamic Contrast**, you can set the level at which the TV automatically enhances the details in the dark, middle and light areas of the picture.

To adjust the level...

- 1 - Press , select **All Settings** and press **OK**.
- 2 - Select **Picture** and press **➤** (right) to enter the menu.
- 3 - Select **Advanced > Contrast > Dynamic Contrast** and press **OK**.
- 4 - Select **Maximum, Medium, Minimum** or **Off**.
- 5 - Press **◀** (left) repeatedly if necessary, to close the menu.

Perfect Contrast

With **Perfect Contrast**, you can set the level at which the TV automatically enhances the details in the dark, middle and light areas of the picture.

To adjust the level...

- 1 - Press , select **All Settings** and press **OK**.
- 2 - Select **Picture** and press **➤** (right) to enter the menu.
- 3 - Select **Advanced > Contrast > Perfect Contrast**, and press **OK**.
- 4 - Select **Maximum, Medium, Minimum** or **Off**.
- 5 - Press **◀** (left) repeatedly if necessary, to close the menu.

Brightness

With **Brightness**, you can set the level of brightness of the picture signal. Brightness is a setting intended for expert users. We recommend non-expert users to adjust the brightness of the picture with the **Contrast** setting.

To adjust the level...

- 1 - Press , select **All Settings** and press **OK**.
- 2 - Select **Picture** and press **➤** (right) to enter the menu.
- 3 - Select **Advanced > Contrast > Brightness**, and press **OK**.
- 4 - Press the arrows **▲** (up) or **▼** (down) to adjust the value.
- 5 - Press **◀** (left) repeatedly if necessary, to close the menu.

Video Contrast

With **Video Contrast**, you can decrease the range of the video contrast.

To adjust the level...

- 1 - Press , select **All Settings** and press **OK**.
- 2 - Select **Picture** and press **➤** (right) to enter the menu.
- 3 - Select **Advanced > Contrast > Video Contrast**, and press **OK**.
- 4 - Press the arrows **▲** (up) or **▼** (down) to adjust the value.
- 5 - Press **◀** (left) repeatedly if necessary, to close the menu.

Gamma

With **Gamma**, you can set a non-linear setting for picture luminance and contrast. Gamma is a setting intended for expert users.

To adjust the level...

- 1 - Press , select **All Settings** and press **OK**.
- 2 - Select **Picture** and press **➤** (right) to enter the menu.
- 3 - Select **Advanced > Contrast > Gamma**, and press **OK**.
- 4 - Press the arrows **▲** (up) or **▼** (down) to adjust the value.
- 5 - Press **◀** (left) repeatedly if necessary, to close the menu.

Sharpness Settings

Super Resolution

With **Super Resolution**, you switch on a superior sharpness in line edges and contours.

To switch on or off...

- 1 - Press , select **All Settings** and press **OK**.
- 2 - Select **Picture** and press **➤** (right) to enter the menu.
- 3 - Select **Advanced > Sharpness > Super Resolution**, and press **OK**.
- 4 - Select **On** or **Off**.
- 5 - Press **◀** (left) repeatedly if necessary, to close the menu.

Noise Reduction

With **Noise Reduction**, you can filter out and reduce the level of image noise.

To adjust the noise reduction...

- 1 - Press , select **All Settings** and press **OK**.
- 2 - Select **Picture** and press **➤** (right) to enter the menu.
- 3 - Select **Advanced > Sharpness > Noise Reduction**, and press **➤** (right) to enter the menu.
- 4 - Select **Maximum, Medium, Minimum** or **Off**.
- 5 - Press **◀** (left) repeatedly if necessary, to close the menu.

the menu.

MPEG Artefact Reduction

With **MPEG Artefact Reduction**, you can smoothen the digital transitions in the picture. MPEG artefacts are mostly visible as small blocks or jagged edges in images.

To reduce the MPEG artefacts...

- 1 - Press , select **All Settings** and press **OK**.
- 2 - Select **Picture** and press **▶** (right) to enter the menu.
- 3 - Select **Advanced** > **Sharpness** > **MPEG Artefact Reduction**, and press **▶** (right) to enter the menu.
- 4 - Select **Maximum**, **Medium**, **Minimum** or **Off**.
- 5 - Press **◀** (left) repeatedly if necessary, to close the menu.

Picture Format

Basic

If the picture is not filling the whole screen, if black bars are showing on the top or bottom or at both sides, you can adjust the picture to fill the screen completely.

To select one of the basic settings to fill the screen...

- 1 - Press  (Picture Format).
 - 2 - Select **Fill Screen** or **Fit to Screen**, and press **OK**.
 - 3 - Press **← BACK** to close the menu.
- **Fill Screen** – automatically enlarges the picture to fill the screen. Picture distortion is minimal, subtitles remain visible. Not suitable for PC input. Some extreme picture formats can still show black bars.
 - **Fit to Screen** – automatically zooms in the picture to fill the screen without distortion. Black bars may be visible. Not suitable for PC input.

Advanced

If the two basic settings are inadequate to format the picture you want, you can use the advanced settings. With the advanced settings you manually format the picture on your screen.

You can zoom, stretch and shift the picture until it shows what you need – e.g. missing subtitles or scrolling text banners. If you format the picture for a specific Source – like a connected game console – you can return to this setting the next time you use the game console. The TV stores the last setting you did for each connection.

To format the picture manually...

- 1 - Press  (Picture Format).
 - 2 - Select **Advanced** and press **OK**.
 - 3 - Use **Shift**, **Zoom**, **Stretch** or **Original** to adjust the picture. Select **Undo** to return to the setting the picture had when you opened **Picture Format**.
- **Shift** – Select on the arrows to shift the picture. You can only shift the picture when it is zoomed in.
 - **Zoom** – Select on the arrows to zoom in.
 - **Stretch** – Select on the arrows to stretch the picture vertically or horizontally.
 - **Undo** – Select to return to the picture format you started with.
 - **Original** – Shows the original format of the incoming picture. This is a 1:1 pixel on pixel format. Expert mode for HD and PC input.

Quick Picture Setting

During the first installation, you did some picture settings in a few easy steps. You can redo these steps with **Quick Picture Setting**. To do these steps, make sure the TV can tune to a TV channel or can show a programme from a connected device.

To set the picture in a few easy steps...

- 1 - Press , select **All Settings** and press **OK**.
- 2 - Select **Picture** and press **▶** (right) to enter the menu.
- 3 - Select **Advanced** > **Quick Picture Setting**, and press **OK**.
- 4 - Select **Start**.
- 5 - Select the picture setting you prefer and go to the next setting.
- 6 - Finally select **Finish**.
- 7 - Press **◀** (left) repeatedly if necessary, to close the menu.

22.2

Sound

Sound Style

Select a Style

For easy sound adjustment, you can select a preset setting with **Sound Style**.

- 1 - While watching a TV channel, press .
- 2 - Select **Sound** and press **▶** (right) to enter the menu.
- 3 - Select **Sound Style**, and select one of the styles in the list.
- 4 - Press **◀** (left) repeatedly if necessary, to close the menu.

The available styles are...

- **Personal** – The sound preferences you set during

the first start up.

- **Original** - Most neutral sound setting
- **Movie** - Ideal for watching movies
- **Music** - Ideal for listening to music
- **Game** - Ideal for gaming

- **News** - Ideal for speech

Restore a Style

With a Sound Style selected, you can adjust any sound setting in **Setup > Sound...**

The selected style will store the changes you made. We recommend to adjust the sound settings for the style **Personal** only. The Sound Style - Personal can save its settings for each individual connected device in Sources menu.

To restore the style to its original setting...

- 1 - While watching a TV channel, press **⚙️**.
- 2 - Select **Sound** and press **➤** (right) to enter the menu.
- 3 - Select **Sound Style** , and select the Sound Style you want to restore.
- 4 - Press the colour key **— Restore Style** . The style is restored
- 5 - Press **⬅** (left) repeatedly if necessary, to close the menu.

Sound Settings

Bass

With **Bass**, you can adjust the level of low tones in the sound.

To adjust the level...

- 1 - Press **⚙️**, select **All Settings** and press **OK**.
- 2 - Select **Sound** and press **➤** (right) to enter the menu.
- 3 - Select **Bass** and press **➤** (right).
- 4 - Press the arrows **▲** (up) or **▼** (down) to adjust the value.
- 5 - Press **⬅** (left) repeatedly if necessary, to close the menu.

Treble

With **Treble**, you can adjust the level of high tones in the sound.

To adjust the level...

- 1 - Press **⚙️**, select **All Settings** and press **OK**.
- 2 - Select **Sound** and press **➤** (right) to enter the menu.
- 3 - Select **Treble** and press **➤** (right).

4 - Press the arrows **▲** (up) or **▼** (down) to adjust the value.

5 - Press **⬅** (left) repeatedly if necessary, to close the menu.

Surround mode

With **Surround Mode**, you can set the sound effect of the TV speakers.

To set the surround mode...

- 1 - Press **⚙️**, select **All Settings** and press **OK**.
- 2 - Select **Sound** and press **➤** (right) to enter the menu.
- 3 - Select **Surround mode** and press **➤** (right) to enter the menu.
- 4 - Select **Stereo** or **Incredible surround**.
- 5 - Press **⬅** (left) repeatedly if necessary, to close the menu.

Advanced Sound Settings

Auto Volume Levelling

With **Auto Volume Levelling**, you can set the TV to automatically level out sudden volume differences. Typically at the beginning of adverts or when you are switching channels.

To switch on or off...

- 1 - Press **⚙️**, select **All Settings** and press **OK**.
- 2 - Select **Sound** and press **➤** (right) to enter the menu.
- 3 - Select **Advanced** and press **➤** (right) to enter the menu.
- 4 - Select **Auto volume levelling** and press **➤** (right) to enter the menu.
- 5 - Select **On** or **Off**.
- 6 - Press **⬅** (left) repeatedly if necessary, to close the menu.

Clear Sound

With **Clear Sound**, you improve the sound for speech. Ideal for news programmes. You can switch the speech improvement on or off.

To switch on or off...

- 1 - Press **⚙️**, select **All Settings** and press **OK**.
- 2 - Select **Sound** and press **➤** (right) to enter the menu.
- 3 - Select **Advanced > Clear sound** and press **OK**.
- 4 - Select **On** or **Off**, then press **OK**.
- 5 - Press **⬅** (left) repeatedly if necessary, to close the menu.

Audio Out Format

For more information, in **Help**, press the colour key **— Keywords** and look up **Audio Out Format**.

Audio Out Levelling

For more information, in **Help**, press the colour key **— Keywords** and look up **Audio Out Levelling**.

Audio Out Delay

If you set an Audio sync delay on your Home Theatre System, to synchronise the sound with the picture, you must switch off **Audio Out Delay** on the TV.

To switch off Audio Out Delay...

- 1 - Press **⚙**, select **All Settings** and press **OK**.
- 2 - Select **Sound** and press **➤** (right) to enter the menu.
- 3 - Select **Advanced > Audio Out Delay** and press **OK**.
- 4 - Select **Off**.
- 5 - Press **◀** (left) repeatedly if necessary, to close the menu.

For more information, in **Help**, press the colour key **— Keywords** and look up **Audio Out Delay**.

Audio Out Offset

If you cannot set a delay on the Home Theatre System, you can set a delay on the TV with **Audio Out Offset**.

To synchronise the sound on the TV...

- 1 - Press **⚙**, select **All Settings** and press **OK**.
- 2 - Select **Sound** and press **➤** (right) to enter the menu.
- 3 - Select **Advanced > Audio Out Offset** and press **OK**.
- 4 - Use the slider bar to set the sound offset and press **OK**.
- 5 - Press **◀** (left) repeatedly if necessary, to close the menu.

For more information, in **Help**, press the colour key **— Keywords** and look up **Audio Out Offset**.

Headphone volume

With **Headphones Volume**, you can set the volume of a connected headphone separately.

To adjust the volume...

- 1 - Press **⚙**, select **All Settings** and press **OK**.
- 2 - Select **Sound** and press **➤** (right) to enter the

menu.

- 3 - Select **Headphones Volume** and press **OK**.
- 4 - Press the arrows **▲** (up) or **▼** (down) to adjust the value.
- 5 - Press **◀** (left) repeatedly if necessary, to close the menu.

Speakers

TV Speakers

You can send the TV sound to a connected audio device - a Home Theatre System or audio system.

You can select where you want to hear the TV sound and how you want to control it.

- If you select **TV Speakers Off**, you permanently switch off the TV speakers.
- If you select **TV Speakers On**, the TV speakers are always on.

With an audio device connected with HDMI CEC, you can use one of the EasyLink settings.

- If you select **EasyLink**, the TV sends the TV sound to the audio device. The TV will switch off the TV speakers when the device is playing the sound.
- If you select **EasyLink Autostart**, the TV will switch on the audio device, send the TV sound to the device and switch off the TV speakers.

With EasyLink or EasyLink Autostart selected, you can still switch to TV speakers if necessary.

To set the TV speakers...

- 1 - Press **⚙**, select **All Settings** and press **OK**.
- 2 - Select **Sound** and press **➤** (right) to enter the menu.
- 3 - Select **Advanced** and press **➤** (right) to enter the menu.
- 4 - Select **TV Speakers** and press **➤** (right) to enter the menu.
- 5 - Select **TV Speakers On**, **TV Speakers Off**, **EasyLink**, or **EasyLink Autostart**.
- 6 - Press **◀** (left) repeatedly if necessary, to close the menu.

To switch to speakers directly...

- 1 - While watching TV, press **⚙**.
- 2 - Select **Speakers** and select **TV** or **Audio System**.
- 3 - Press **◀** (left) repeatedly if necessary, to close the menu.

Wireless Speakers

What You Need

You can connect a wireless speaker (a subwoofer or a sound bar) to this TV.

A range of selected Philips wireless speaker products

can connect and play the TV sound. Consult the Philips website for suited wireless audio products for this TV - www.philips.com/tv

To play the TV sound on a wireless speaker, you must pair the wireless speaker with the TV. You can pair up to 10 wireless speakers but you can only play the sound on one wireless audio speaker at a time. If you connect a subwoofer, the sound is played on the TV and the subwoofer. If you connect a sound bar the sound is played on the sound bar only.

Select a Speaker

To connect a wireless speaker...

- 1 - Press , select **All Settings** and press **OK**.
- 2 - Select **Sound** and press **➤** (right) to enter the menu.
- 3 - Select **Wireless Speakers > Connect a Speaker** and press **OK**.
- 4 - Press **◀** (left) repeatedly if necessary, to close the menu.

Remove a Speaker

To remove a wireless speaker...

- 1 - Press , select **All Settings** and press **OK**.
- 2 - Select **Sound** and press **➤** (right) to enter the menu.
- 3 - Select **Wireless Speakers > Remove a Speaker** and press **OK**.
- 4 - Press **◀** (left) repeatedly if necessary, to close the menu.

Subwoofer Volume

To adjust the volume of wireless speaker...

- 1 - Press , select **All Settings** and press **OK**.
- 2 - Select **Sound** and press **➤** (right) to enter the menu.
- 3 - Select **Wireless Speakers > Subwoofer Volume** and press **OK**.
- 4 - Press **◀** (left) repeatedly if necessary, to close the menu.

Problems

Lost connection

- Position the wireless speaker within a range of 5 meters from the TV.
- Places with a high amount of wireless activity - apartments with lots of wireless routers - can hamper the wireless connection. Keep the router and wireless speaker as close to the TV as possible.

Audio and video mismatch

- Some wireless speakers systems might have audio and video sync problems. We recommend using Philips wireless audio products.

22.3

Eco Settings

Energy Saving

Eco settings  bundles the settings that help the environment.

Energy Saving

If you select Energy Saving, the TV switches to Picture Style - Standard automatically, the most ideal energy conscious setting for the picture.

To set the TV in Energy Saving...

- 1 - Press , select **All Settings** and press **OK**.
- 2 - Select **Eco Settings** and press **➤** (right) to enter the menu.
- 3 - Select **Energy Saving**, the **Picture Style** is set to **Standard** automatically.
- 4 - Press **◀** (left) repeatedly if necessary, to close the menu.

Screen Off

If you only listen to music, you can switch off the TV screen to save energy.

To only switch off the TV screen...

- 1 - Press , select **All Settings** and press **OK**.
- 2 - Select **Eco Settings** and press **➤** (right) to enter the menu.
- 3 - Select **Screen Off**.
- 4 - Press **◀** (left) repeatedly if necessary, to close the menu.

To switch the screen back on, press any key on the remote control.

Switch Off Timer

If the TV receives a TV signal but you don't press a key on the remote control during a 4 hour period, the TV switches off automatically to save energy. Also, if the TV does not receive a TV signal nor a remote control command for 10 minutes, the TV switches off automatically.

If you use the TV as a monitor or use a digital receiver to watch TV (a Set-Top Box - STB) and you do not use the remote control of the TV, you should deactivate this automatic switch off.

To deactivate the Switch Off Timer ...

- 1 - Press , select **All Settings** and press **OK**.
- 2 - Select **Eco Settings** and press **➤** (right) to enter the menu.
- 3 - Select **Switch Off Timer**. Select inside the slider bar to adjust the value. The value **0 (Off)** deactivates the automatic switch off.
- 4 - Press **◀** (left) repeatedly if necessary, to close the menu.

22.4

General Settings

EasyLink

EasyLink

To switch off EasyLink completely...

- 1 - Press , select **All Settings** and press **OK**.
- 2 - Select **General Settings** and press **➤** (right) to enter the menu.
- 3 - Select **EasyLink**, press **➤** (right) and select **EasyLink** one step further.
- 4 - Select **Off**.
- 5 - Press **◀** (left) repeatedly if necessary, to close the menu.

EasyLink Remote Control

To switch off EasyLink remote control...

- 1 - Press , select **All Settings** and press **OK**.
- 2 - Select **General Settings** and press **➤** (right) to enter the menu.
- 3 - Select **EasyLink > Easylink Remote Control**, and press **OK**.
- 4 - Select **Off**.
- 5 - Press **◀** (left) repeatedly if necessary, to close the menu.

Android Settings

You can set or view several Android specific settings or information. You can find the list of apps installed on your TV and the storage space they need. You can set the language you like to use with Voice Search. You can configure the onscreen keyboard or allow apps to use your location. Explore the different Android settings. You can go to www.support.google.com/androidtv for more information on these settings.

To open these settings...

- 1 - Press , select **All Settings** and press **OK**.
- 2 - Select **Android Settings**, and press **OK**.
- 3 - Explore the different Android settings.

- 4 - Press **◀** **BACK** if necessary, to close the menu.

USB Hard Drive

To set up and format a USB Hard Drive...

- 1 - Press , select **All Settings** and press **OK**.
- 2 - Select **General Settings** and press **➤** (right) to enter the menu.
- 3 - Select **USB Hard Drive**, and press **OK**.
- 4 - Select **Start**, then follow the instructions on screen.
- 5 - Press **◀** (left) repeatedly if necessary, to close the menu.

For more information on how to install a USB Hard Drive, in **Help**, press the colour key  **Keywords** and look up **USB Hard Drive, installation**.

USB Keyboard Settings

To install the USB keyboard, switch on the TV and connect the USB keyboard to one of the **USB** connections on the TV. When the TV detects the keyboard for the first time, you can select your keyboard lay-out and test your selection. If you select a Cyrillic or Greek keyboard layout first, you can select a secondary Latin keyboard layout.

To change the keyboard layout setting when a layout was selected...

- 1 - Press , select **All Settings** and press **OK**.
- 2 - Select **General Settings** and press **➤** (right) to enter the menu.
- 3 - Select **USB Keyboard Settings**, and press **OK** to start the keyboard setup.

HbbTV

If a TV channel offers HbbTV pages, you must first switch on HbbTV in the TV settings to view the pages.

- 1 - Press , select **All Settings** and press **OK**.
- 2 - Select **General Settings** and press **➤** (right) to enter the menu.
- 3 - Select **Advanced > HbbTV**, and press **OK**.
- 4 - Select **On** or **Off**.
- 5 - Press **◀** (left) repeatedly if necessary, to close the menu.

If you want to avoid access to HbbTV pages on a specific channel, you can block the HbbTV pages for this channel only.

- 1 - Tune to the channel of which you want to block the HbbTV pages.
- 2 - Press  **OPTIONS** and select **HBB TV on This Channel** and press **OK**.

3 - Select **Off** and press **OK**.

Home or Shop

If the TV is installed in a shop, you can set the TV to display an in store promotion banner. **Picture Style** is set to **Vivid** automatically. **Switch Off Timer** is switched off.

To set the TV to Shop location...

- 1 - Press **⚙️**, select **All Settings** and press **OK**.
- 2 - Select **General Settings** and press **➤** (right) to enter the menu.
- 3 - Select **Location > Shop**, and press **OK**.
- 4 - Press **◀** (left) repeatedly if necessary, to close the menu.

If you use the TV at home, set the TV in Home location.

Shop Setup

If the TV is set to **Shop**, you can set the availability of a specific demo for in store use.

- 1 - Press **⚙️**, select **All Settings** and press **OK**.
- 2 - Select **General Settings** and press **➤** (right) to enter the menu.
- 3 - Select **Shop Setup** and press **➤** (right) to enter the menu.
- 4 - Select **Off** or **Feature Promotion Banner** as in store demo
- 5 - Press **◀** (left) repeatedly if necessary, to close the menu.

TV Placement

As part of the first installation, this setting is set to either **On a TV stand** or **On the Wall**. If you have changed the placement of the TV since then, adjust this setting accordingly for best sound reproduction.

- 1 - Press **⚙️**, select **All Settings** and press **OK**.
- 2 - Select **General Settings** and press **➤** (right) to enter the menu.
- 3 - Select **TV Placement** and press **OK**.
- 4 - Select **On a TV stand** or **On the Wall**.
- 5 - Press **◀** (left) repeatedly if necessary, to close the menu.

TV Guide

For more information, in **Help**, press the colour key **— Keywords** and look up **TV Guide, data and information**.

Channel Logos

In some countries, the TV can show the channel logos.

If you do not want these logos to appear, you can switch them off.

To switch off the logos...

- 1 - Press **⚙️**, select **All Settings** and press **OK**.
- 2 - Select **General Settings** and press **➤** (right) to enter the menu.
- 3 - Select **Advanced > Channel Logos** and press **➤** (right) to enter the menu.
- 4 - Select **Off** and press **OK**.
- 5 - Press **◀** (left) repeatedly if necessary, to close the menu.

Factory Settings

You can set the TV back to the original TV settings (the factory settings).

To switch back to the original settings...

- 1 - Press **⚙️**, select **All Settings** and press **OK**.
- 2 - Select **General Settings** and press **➤** (right) to enter the menu.
- 3 - Select **Factory Settings** and press **OK**.
- 4 - Press **◀** (left) repeatedly if necessary, to close the menu.

Child Lock

Parental Rating

To set a minimum age to watch rated programmes...

- 1 - Press **⚙️**, select **All Settings** and press **OK**.
- 2 - Select **Child Lock** and press **➤** (right) to enter the menu.
- 3 - Select **Parental Rating**, and select one of the age in the list.
- 4 - Press **◀** (left) repeatedly if necessary, to close the menu.

App Lock

For more information, in **Help**, press the colour key **— Keywords** and look up **APP lock** for more information.

Set Code / Change Code

The Child Lock PIN code is used to lock or unlock channels or programmes.

To set the lock code or to change the current code...

- 1 - Press **⚙**, select **All Settings** and press **OK**.
- 2 - Select **Child Lock** and press **➤** (right) to enter the menu.
- 3 - Select **Set Code or Change Code** and press **OK**.
- 4 - Enter a 4 digit code of your choice. If a code is set already, enter the current Child Lock code and then enter the new code twice.
- 5 - Press **◀** (left) repeatedly if necessary, to close the menu.

The new code is set.

Forgotten your Child Lock PIN code?

If you forgot your PIN code, you can override the current code and enter a new code.

- 1 - Press **⚙**, select **All Settings** and press **OK**.
- 2 - Select **Child Lock** and press **➤** (right) to enter the menu.
- 3 - Select **Change Code** and press **OK**.
- 4 - Enter the overriding code **8888**.
- 5 - Now enter a new Child Lock PIN code and enter it again to confirm.
- 6 - Press **◀** (left) repeatedly if necessary, to close the menu.

The new code is set.

Reinstall TV

You can redo a full TV installation. The TV is completely reinstalled.

To redo a full TV installation...

- 1 - Press **⚙**, select **All Settings** and press **OK**.
- 2 - Select **General Settings** and select **Reinstall TV**.
- 3 - Follow the instructions on screen. The installation may take a few minutes.

22.5

Clock, Region and Language

Menu Language

To change the language of the TV menus and messages...

- 1 - Press **⚙**, select **All Settings** and press **OK**.
- 2 - Select **Region and Language** and press **➤** (right) to enter the menu.
- 3 - Select **Language > Menu Language** and press **OK**.
- 4 - Select on the language you need.
- 5 - Press **◀** (left) repeatedly if necessary, to close the menu.

Language preferences

Audio Language Settings

Digital TV channels can broadcast audio with several spoken languages for a programme. You can set a preferred primary and secondary audio language. If audio in one of these languages is available, the TV will switch to this audio.

If none of the preferred audio languages is available, you can select another audio language which is available.

To set the primary and secondary audio language...

- 1 - Press **⚙**, select **All Settings** and press **OK**.
- 2 - Select **Region and Language** and press **➤** (right) to enter the menu.
- 3 - Select **Languages > Primary Audio or Secondary Audio** and press **OK**.
- 4 - Select on the language you need.
- 5 - Press **◀** (left) repeatedly if necessary, to close the menu.

To select an audio language when none of your preferred audio language is available...

- 1 - Press **≡ OPTIONS**.
- 2 - Select **Audio Language** and select on the audio language you want temporarily.

Subtitles

Switch On

To switch on Subtitles, press **SUBTITLE**.

You can switch subtitles **On**, **Off** or **On During Mute**.

Or to show subtitles automatically when the broadcasted programme is not in language – the language set for the TV – select **Automatic**. This setting will also show Subtitles automatically when

you mute the sound.

Subtitle Language Settings

Digital channels can offer several subtitle languages for a programme. You can set a preferred primary and secondary subtitle language. If subtitles in one of these languages are available, the TV will show the subtitles you selected.

If none of the preferred subtitle languages are available, you can select another subtitle language which is available.

To set the primary and secondary subtitle language...

- 1 - Press , select **All Settings** and press **OK**.
- 2 - Select **Region and Language** and press **>** (right) to enter the menu.
- 3 - Select **Languages > Primary Subtitles** or **Secondary Subtitles** and press **OK**.
- 4 - Select on the language you need.
- 5 - Press **<** (left) repeatedly if necessary, to close the menu.

To select a subtitle language when none of your preferred languages are available...

- 1 - Press  **OPTIONS**.
- 2 - Select **Subtitle Language** and select on the language you want temporarily.

Subtitles from Text

If you tune to an analogue channel, you need to make the subtitles available for each channel manually.

- 1 - Switch to a channel and press **TEXT** to open Text.
- 2 - Enter the page number for subtitles, usually **888**.
- 3 - Press **TEXT** again, to close Text.

If you select **On** in the Subtitle menu when watching this analogue channel, subtitles will be shown if available.

To know if a channel is analogue or digital, switch to the channel and open **Channel Info** in  **OPTIONS**.

Text / Teletext Languages

Text Pages

To open Text/Teletext press **TEXT**, while you are watching TV channels.

To close Text, press **TEXT** again.

Select a Text page

To select a page . . .

- 1 - Enter the page number with the number keys.
- 2 - Use the arrow keys to navigate.
- 3 - Press a colour key to select a colour-coded subject at the bottom of the screen.

Text sub-pages

A Text page number can hold several subpages. The subpage numbers are shown on a bar next to the main page number.

To select a subpage, press **<** or **>**.

T.O.P. Text pages

Some broadcasters offer T.O.P. Text.

To open T.O.P. Text pages within Text, press  **OPTIONS** and select **T.O.P. overview**.

Favourite pages

The TV makes a list of the last 10 Text pages you opened. You can easily reopen them again in the Favourite Text pages column.

- 1 - In Text, select the star in the top left corner of the screen to show the column of favourite pages.
- 2 - Press **▼** (down) or **▲** (up) to select a page number and press **OK** to open the page. You can clear the list with the option **Clear favourite pages**.

Search Text



You can select a word and scan Text for all occurrences of this word.

- 1 - Open a Text page and press **OK**.
- 2 - Select a word or number with the arrow keys.
- 3 - Press **OK** again to jump immediately to the next occurrence of this word or number.
- 4 - Press **OK** again to jump to the subsequent occurrence.
- 5 - To stop searching, press **▲** (up) until nothing is selected.

Text from a connected device

Some devices that receive TV channels can also offer Text.

To open Text from a connected device . . .

- 1 - Press  select the device and press **OK**.
- 2 - While watching a channel on the device, press  **OPTIONS**, select **Show device keys** and select the  key and press **OK**.
- 3 - Press **← BACK** to hide the device keys.
- 4 - To close Text, press **← BACK** again.

Digital Text (UK only)

Some digital broadcasters offer dedicated Digital Text or interactive TV on their digital TV channels. This includes normal Text using the number, colour and arrow keys to select and navigate.

To close Digital Text, press **← BACK**.

Text Options

In Text/Teletext, press **≡** **OPTIONS** to select the following...

- **Freeze page**

To stop the automatic rotation of subpages.

- **Dual screen / Full screen**

To show the TV channel and Text alongside each other.

- **T.O.P. overview**

To open T.O.P. Text.

- **Enlarge**

To enlarge the Text page for comfortable reading.

- **Reveal**

To unhide hidden information on a page.

- **Cycle subpages**

To cycle subpages when these are available.

- **Language**

To switch the group of characters that Text uses to display correctly.

- **Text 2.5**

To activate the Text 2.5 for more colours and better graphics.

Text Setup

Text language

Some digital TV broadcasters have several Text languages available.

To set your primary and secondary Text language . . .

1 - Press **⚙**, select **All Settings** and press **OK**.

2 - Select **Region and Language** and press **➤** (right) to enter the menu.

3 - Select **Language > Primary Text** or **Secondary Text** and press **OK**.

4 - Select your preferred Text languages.

5 - Press **◀** (left) repeatedly if necessary, to close the menu.

Text 2.5

If available, Text 2.5 offers more colours and better graphics. Text 2.5 is activated as a standard factory setting.

To switch off Text 2.5...

1 - Press **TEXT**.

2 - With Text/Teletext open on screen, press **≡** **OPTIONS**.

3 - Select **Text 2.5 > Off**.

4 - Press **◀** (left) repeatedly if necessary, to close the menu.

Clock

Date and Time

Automatic

To know what time it is, press **🏠**. The **Home Menu** always shows what time it is.

In some countries, digital broadcasts do not send UTC - Coordinated Universal Time information. The daylight saving change might be ignored and the TV might show an incorrect time.

When you record programmes - scheduled in the TV Guide, we recommend not to change the time and date manually. In some countries, for some network operators, the **Clock** setting is hidden to avoid an incorrect clock setting.

To correct the TV clock automatically...

1 - Press **⚙**, select **All Settings** and press **OK**.

2 - Select **Region and Language** and press **➤** (right) to enter the menu.

3 - Select **Clock > Auto Clock Mode**, and select **Country Dependent**.

4 - Select **Daylight saving** and select the appropriate setting.

5 - Press **◀** (left) repeatedly if necessary, to close the menu.

Manual

To set the TV clock manually...

1 - Press **⚙**, select **All Settings** and press **OK**.

2 - Select **Region and Language** and press **➤** (right) to enter the menu.

3 - Select **Clock > Auto Clock Mode**, and select **Manual**.

4 - Select **Date and Time** to adjust.

5 - Press **◀** (left) repeatedly if necessary, to close the menu.

Time Zone

To set the time zone...

1 - Press **⚙**, select **All Settings** and press **OK**.

2 - Select **Region and Language** and press **➤** (right) to enter the menu.

3 - Select **Clock > Time Zone**, and press **OK**.

4 - Select one of the time zones.

5 - Press **◀** (left) repeatedly if necessary, to close the menu.

Remote Control Keyboard

To set the keyboard layout to Azerty...

- 1 - Press , select **All Settings** and press **OK**.
- 2 - Select **Region and Language** and press **➤** (right) to enter the menu.
- 3 - Select **Remote Control Keyboard** and press **OK**.
- 4 - Select **Azerty** or **Qwerty** and press **OK**.
- 5 - Press **◀** (left) repeatedly if necessary, to close the menu.

22.6

Universal Access

Switch On

With **Universal Access** switched on, the TV is prepared for use for the deaf, hard of hearing, blind or partially sighted people.

Switch on

If you did not switch on **Universal Access** during the installation, you can still switch it on in **Universal Access** menu.

To switch on Accessibility...

- 1 - Press , select **All Settings** and press **OK**.
- 2 - Select **Universal Access** and press **➤** (right) to enter the menu.
- 3 - Select **Universal Access** one step further.
- 4 - Select **On** and press **OK**.
- 5 - Press **◀** (left) repeatedly if necessary, to close the menu.

With **Universal Access** switched on, the option **Universal Access** is added in the Options menu.

Hard of Hearing

Some digital TV channels broadcast special audio and subtitles adapted for the hard of hearing or deaf people. With **Hearing impaired** switched on, the TV automatically switches to the adapted audio and subtitles, if available. Before you can switch on **Hearing impaired**, you have to switch on **Universal Access**.



To switch on **Hearing impaired**...

- 1 - Press , select **All Settings** and press **OK**.
- 2 - Select **Universal Access** and press **➤** (right) to enter the menu.
- 3 - Select **Hearing impaired** and press **➤** (right) to enter the menu.
- 4 - Select **On** and press **OK**.
- 5 - Press **◀** (left) repeatedly if necessary, to close

the menu.

To switch on **Hearing impaired** while watching TV...

- 1 - While watching a TV channel, press  **OPTIONS**, select **Universal Access** and press **OK**.
- 2 - Select **Hearing impaired**, and select **On**.

To check whether a hearing impaired audio language is available, press  **OPTIONS**, select **Audio Language** and look for an audio language marked with a .

If Accessibility does not appear in the Options menu, switch on **Universal Access** in setup menu.

For more information, in **Help**, press the colour key  **Keywords** and look up **Universal Access**.

Audio Description

Switch On

Digital TV channels can broadcast special audio commentary describing what is happening on screen.

To be able to set the visually impaired audio and effects, you have to switch on **Audio Description** first.

Also, before you can switch on **Audio Description**, you have to switch on **Universal Access** in setup menu.

With **Audio Description**, a narrator's commentary is added to the normal audio.

To switch on the commentary (if available)...

To switch on **Audio Description**...

- 1 - Press , select **All Settings** and press **OK**.
- 2 - Select **Universal Access** and press **➤** (right) to enter the menu.
- 3 - Select **Audio Description** and press **➤** (right) to enter the menu.
- 4 - Select **Audio Description** one step further
- 5 - Select **On** and press **OK**.
- 6 - Press **◀** (left) repeatedly if necessary, to close the menu.

To switch on **Audio Description** while watching TV...

- 1 - While watching a TV channel, press  **OPTIONS**, select **Universal Access** and press **OK**.
- 2 - Select **Audio Description**, and select **On**.

You can check if an audio commentary is available. In the Options menu, select **Audio Language** and look for an audio language marked with a .

Speakers/Headphones

With **Speakers/Headphones**, you can select where you want to hear the audio commentary. On the TV speakers only, on the headphones only or on both.

To set Speakers/Headphones...

- 1 - Press , select **All Settings** and press **OK**.
- 2 - Select **Universal Access** and press **➤** (right) to enter the menu.
- 3 - Select **Audio Description** > **Speakers/Headphones** and press **OK**.
- 4 - Select **Speakers, Headphones** or **Speakers + Headphones** and press **OK**.
- 5 - Press **◀** (left) repeatedly if necessary, to close the menu.

Mixed Volume

You can mix the volume of the normal audio with the audio commentary.

To mix the volume...

- 1 - Press , select **All Settings** and press **OK**.
- 2 - Select **Universal Access** and press **➤** (right) to enter the menu.
- 3 - Select **Audio Description** > **Mixed Volume** and press **OK**.
- 4 - Press the arrows **▲** (up) or **▼** (down) to adjust the value.
- 5 - Press **◀** (left) repeatedly if necessary, to close the menu.

If an audio language with added audio commentary is available, you can also find this setting in **≡ OPTIONS** > **Universal Access** > **Mixed Volume**.

Audio Effect

Some audio commentary can hold extra audio effects, like stereo or fading sound.

To switch on **Audio effects** (if available)...

- 1 - Press , select **All Settings** and press **OK**.
- 2 - Select **Universal Access** and press **▶** (right) to enter the menu.
- 3 - Select **Audio Description** > **Audio Effects** and press **OK**.
- 4 - Press **◀** (left) repeatedly if necessary, to close the menu.

Speech

The audio commentary can also hold subtitles for the words which are spoken.

To switch on these subtitles (if available) . . .

- 1 - Press , select **All Settings** and press **OK**.
- 2 - Select **Universal Access** and press **➤** (right) to enter the menu.
- 3 - Select **Audio Description** > **Speech** and press **OK**.
- 4 - Select **Descriptive** or **Subtitles** and press **OK**.
- 5 - Press **◀** (left) repeatedly if necessary, to close the menu.

Wireless and Networks

23.1

Network

For more information, in **Help**, press the colour key **— Keywords** and look up **Network**, for more information on connecting the TV to a network.

23.2

Bluetooth

What You Need

You can connect a wireless device with Bluetooth® to this TV – a wireless speaker, a subwoofer, a sound bar or headphones. You can also connect a wireless gamepad with Bluetooth LE.

To play the TV sound on a wireless speaker, you must pair the wireless speaker with the TV. You can pair some wireless speakers and a maximum of 4 Bluetooth LE (low energy) devices. The TV can only play the sound on one speaker at a time. If you connect a subwoofer, the sound is played on the TV and the subwoofer. If you connect a sound bar the sound is played on the sound bar only.

Attention - Audio to Video synchronisation

Many Bluetooth speaker systems have a high, so called, 'latency'. High latency means that the audio lags behind the video, causing unsynchronised 'lip sync'. Before you purchase a wireless Bluetooth speaker system, inform yourself about the newest models and look for a device with a low latency rating. Ask your dealer for advice.

For more information on how to pair a wireless speaker, in **Help**, press the colour key **— Keywords** and look up **Bluetooth, Pairing**.

Pairing a Device

For more information, in **Help**, press the colour key **— Keywords** and look up **Bluetooth, Pairing** for more information on pairing wireless devices.

Select a Device

For more information, in **Help**, press the colour key **— Keywords** and look up **Bluetooth, Select device** for more information on how to select a wireless speaker.

Remove a Device

For more information, in **Help**, press the colour key **— Keywords** and look up **Bluetooth, Remove device** for more information on how to unpair (remove) a wireless Bluetooth device.

Bluetooth On or Off

To connect wireless Bluetooth devices, make sure Bluetooth is switched on.



To switch Bluetooth on...

- 1 - Press **⚙️**, select **All Settings** and press **OK**.
- 2 - Select **Wireless and Networks** and press **OK**.
- 3 - Select **Bluetooth > Bluetooth On/Off** and press **OK**.
- 4 - Select **On** or **Off** and press **OK**.
- 5 - Press **⬅️** (left) repeatedly if necessary, to close the menu.

Android Settings

You can set or view several Android specific settings or information. You can find the list of apps installed on your TV and the storage space they need. You can set the language you like to use with Voice Search. You can configure the onscreen keyboard or allow apps to use your location. Explore the different Android settings. You can go to www.support.google.com/androidtv for more information on these settings.

To open these settings...

- 1 - Press , select **All Settings** and press **OK**.
- 2 - Select **Android Settings**, and press **OK**.
- 3 - Explore the different Android settings.
- 4 - Press  **BACK** if necessary, to close the menu.

Channel Installation

Antenna/Cable Installation

Update Channels

Automatic Channel Update

If you receive digital channels, you can set the TV to automatically update these channels.

Once a day, at 6 AM, the TV updates the channels and stores new channels. New channels are stored in the Channels List and are marked with a **★**.

Channels without a signal are removed. The TV must be in standby to automatically update channels. You can switch off Automatic Channel Update.

To switch off the automatic update...

- 1 - Press **⚙**, select **All Settings** and press **OK**.
- 2 - Select **Channels > Antenna/Cable Installation** and press **OK**.
- 3 - Enter your PIN code if necessary.
- 4 - Select **Automatic Channel Update** and press **OK**.
- 5 - Select **Off** and press **OK**.
- 6 - Press **← BACK** to close the menu.

When new channels are found or if channels are updated or removed, a message is shown at TV start up. To avoid this message to appear after every channel update, you can switch it off.

To switch off the message...

- 1 - Press **⚙**, select **All Settings** and press **OK**.
- 2 - Select **Channels > Antenna/Cable Installation** and press **OK**.
- 3 - Enter your PIN code if necessary.
- 4 - Select **Channel Update Message** and press **OK**.
- 5 - Select **Off** and press **OK**.
- 6 - Press **← BACK** to close the menu.

In certain countries, the Automatic channel update is done while watching TV or on any moment when the TV is in standby.

Manual Channel Update

You can always start an channel update yourself.

To start a channel update manually...

- 1 - Press **⚙**, select **All Settings** and press **OK**.
- 2 - Select **Channels > Antenna/Cable Installation** and press **OK**.
- 3 - Enter your PIN code if necessary.
- 4 - Select **Search for Channels** and press **OK**.
- 5 - Select **Start** and press **OK**.

6 - Select **Update Digital Channels**, select **Next** and press **OK**.

7 - Select **Start** and press **OK** to update the digital channels. This can take a few minutes.

8 - Press **← BACK** to close the menu.

Reinstall Channels

Reinstall All Channels

You can reinstall all channels and leave all other TV settings untouched.

If a PIN code is set, you will need to enter this code before you can reinstall channels.

To reinstall channels...

- 1 - Press **⚙**, select **All Settings** and press **OK**.
- 2 - Select **Channels > Antenna/Cable Installation** and press **OK**.
- 3 - Enter your PIN code if necessary.
- 4 - Select **Search for Channels** and press **OK**.
- 5 - Select **Start** and press **OK**.
- 6 - Select **Reinstall Channels**, select **Next** and press **OK**.
- 7 - Select the country where you are now and press **OK**.
- 8 - Select **Next** and press **OK**.
- 9 - Select the type of installation you want, **Antenna (DVB-T)** or **Cable (DVB-C)** and press **OK**.
- 8 - Select **Next** and press **OK**.
- 11 - Select the type of channels you want, **Digital and Analogue Channels** or **Only Digital Channels** and press **OK**.
- 8 - Select **Next** and press **OK**.
- 13 - Select **Start** and press **OK** to update the digital channels. This can take a few minutes.
- 14 - Press **← BACK** to close the menu.

Reinstall TV

You can redo a full TV installation. The TV is completely reinstalled.

To redo a full TV installation...

- 1 - Press **⚙**, select **All Settings** and press **OK**.
- 2 - Select **General Settings > Reinstall TV** and press **OK**.
- 3 - Enter your PIN code if necessary.
- 4 - Select **Yes** and press **OK** to confirm.
- 5 - The TV will reinstall completely. All settings will be reset and installed channels will be replaced. The installation can take a few minutes.
- 6 - Press **← BACK** to close the menu.

DVB-T or DVB-C

DVB-T or DVB-C Reception

During the channel installation, just before you search for channels, you selected Antenna (DVB-T) or Cable (DVB-C). Antenna DVB-T searches for terrestrial analogue channels and digital DVB-T/T2 channels. Cable DVB-C searches for analogue and digital channels available from a cable DVB-C operator.

DVB-C Channel Installation

For ease of use, all DVB-C settings are set to automatic.

If your DVB-C operator gave you specific DVB-C values, the network ID or network frequency, enter these values when the TV asks for them during installation.

Channel Number Conflicts

In some countries, different TV channels (broadcasters) might have the same channel number. While installing, the TV shows the list with channel number conflicts. You need to select which TV channel you want to install on a channel number with multiple TV channels.

DVB Settings

Network Frequency Mode

If you intend to use the fast **Quick Scan** method in **Frequency Scan** to search for channels, select **Automatic**. The TV will use 1 of the predefined network frequencies (or HC - homing channel) as used by most cable operator in your country.

If you received a specific network frequency value to search for channels, select **Manual**.

Network Frequency

With the **Network Frequency Mode** set to **Manual**, you can enter the network frequency value received from your cable operator here. To enter the value, use the number keys.

Frequency Scan

Select the method of searching for channels. You can select the faster **Quick Scan** method and use the predefined settings used by most cable operator in your country.

If this results in having no channels installed or if some channels are missing, you can select the extended **Full Scan** method. This method will take

more time to search for and install channels.

Frequency Step Size

The TV searches for channels in steps of **8MHz**.

If this results in having no channels installed or if some channels are missing, you can search in smaller steps of **1MHz**. Using the 1MHz steps will take more time to search for and install channels.

Digital Channels

If you know your cable operator is not offering digital channels, you can skip searching for digital channels.

Analogue Channels

If you know your cable operator is not offering analogue channels, you can skip searching for analogue channels.

Free / Scrambled

If you have a subscription and a CAM - Conditional Access Module for pay TV services, select **Free + Scrambled**. If you did not subscribe to pay TV channels or services, you can select **Free Channels Only**.

For more information, in **Help**, press the colour key **Keywords** and look up **CAM, Conditional Access Module**.

Reception Quality

You can check the quality and signal strength of a digital channel. If you have your own antenna, you can reposition the antenna to try and improve the reception.

To check the reception quality of a digital channel...

- 1 - Tune to the channel.
- 2 - Press **⚙️**, select **All Settings** and press **OK**.
- 3 - Select **Channels > Antenna/Cable Installation** and press **OK**. Enter your PIN code if necessary.
- 4 - Select **Digital: Reception Test** and press **OK**.
- 5 - Select **Search** and press **OK**. The digital frequency is shown for this channel.
- 6 - Select **Search** again and press **OK** to check the signal quality of this frequency. The test result is shown on screen. You can reposition the antenna or check the connections to possibly improve the reception.
- 7 - You can also change the frequency

yourself. Select the frequency number one by one and use the **▲** (up) or **▼** (down) keys to change the value. Select **Search** and press **OK** to test the reception again.

8 - Press **◀** (left) repeatedly if necessary, to close the menu.

Manual Installation

Analogue TV channels can be manually installed, channel by channel.

To install analogue channels manually...

- 1 - Press **⚙️**, select **All Settings** and press **OK**.
- 2 - Select **Channels > Antenna/Cable Installation** and press **OK**. Enter your PIN code if necessary.
- 3 - Select **Analogue: Manual Installation** and press **OK**.

• System

To set up the TV system, select **System**. Select your country or the part of the world where you are now and press **OK**.

• Search Channel

To find a channel, select **Search Channel** and press **OK**. You can enter a frequency yourself to find a channel or let the TV search for a channel. Press **▶** (right) to select **Search** and press **OK** to search for a channel automatically. The found channel is shown on screen and if the reception is poor, press **Search** again. If you want to store the channel, select **Done** and press **OK**.

• Store

You can store the channel on the current channel number or as a new channel number. Select **Store Current Channel** or **Store as New Channel** and press **OK**. The new channel number is shown briefly.

You can redo these steps until you have found all available analogue TV channels.

25.2

Channel List Copy

Introduction

Channel List Copy is intended for dealers and expert users.

With Channel List Copy, you can copy the channels installed on one TV onto another Philips TV of the same range. With Channel List Copy, you avoid the time-consuming channel search by uploading a predefined channel list on a TV. Use a USB flash drive of minimum 1 GB.

Conditions

- Both TVs are from the same year range.
- Both TVs have the same hardware type. Check the hardware type on the TV type plate on the back of the TV. Typically noted as Q . . . LA
- Both TVs have compatible software versions.

Current software version

To check the current version of the TV software...

- 1 - Press **⚙️**, select **All Settings** and press **OK**.
- 2 - Select **Update Software** and press **▶** (right) to enter the menu.
- 3 - Select **Current Software Info** and press **OK**.
- 4 - The version, release notes and creation date are shown.
- 5 - Press **◀** (left) repeatedly if necessary, to close the menu.

Copy a Channel List

To copy a channel list...

- 1 - Switch on the TV. This TV should have channels installed.
- 2 - Plug in a USB flash drive.
- 3 - Press **⚙️**, select **All Settings** and press **OK**.
- 4 - Select **Channels > Channel List Copy** and press **OK**.
- 5 - Select **Copy to USB** and press **OK**. You might be asked to enter the Child Lock PIN code to copy the channel list.
- 6 - When copying is done, unplug the USB flash drive.
- 7 - Press **◀** (left) repeatedly if necessary, to close the menu.

Now you can upload the copied channel list onto another Philips TV.

Channel list version

Check the current version of the channel list...

- 1 - Press **⚙️**, select **All Settings** and press **OK**.
- 2 - Select **Channels** and press **▶** (right) to enter the menu.
- 3 - Select **Channel List Copy** and select **Current Version**, then press **OK**.
- 4 - Press **◀** (left) repeatedly if necessary, to close the menu.

Upload a Channel List

To not Installed TVs

Depending on whether your TV is already installed or not, you must use a different method to upload a channel list.

To a TV that is not yet installed

1 - Plug in the power plug to start the installation and select language and country. You can skip the channel search. Finish the installation.

2 - Plug in the USB flash drive that holds the channel list of the other TV.

3 - To start the channel list upload, press , select **All Settings** and press **OK**.

4 - Select **Channels > Channel List Copy > Copy to TV** and press **OK**. Enter your PIN code if necessary.

5 - The TV notifies you if the channel list is copied to the TV successfully. Unplug the USB flash drive.

To Installed TVs

Depending on whether your TV is already installed or not, you must use a different method to upload a channel list.

To an already installed TV

1 - Verify the country setting of the TV. (To verify this setting, see chapter Reinstall All Channels. Start this procedure until you reach the country setting.

Press  **BACK** to cancel the installation.)

If the country is correct continue with step 2.

If the country is not correct, you need to start a reinstallation. See chapter Reinstall All Channels and start the installation. Select the correct country and skip the channels search. Finish the installation. When done, continue with step 2.

2 - Plug in the USB flash drive that holds the channel list of the other TV.

3 - To start the channel list upload, press , select **All Settings** and press **OK**.

4 - Select **Channels > Channel List Copy > Copy to TV** and press **OK**. Enter your PIN code if necessary.

5 - The TV notifies you if the channel list is copied to the TV successfully. Unplug the USB flash drive.

Software

26.1

Update Software

Update from Internet



If the TV is connected to the Internet, you may receive a message to update the TV software. You need a high-speed (broadband) Internet connection. If you receive this message, we recommend you to carry out the update.

With the message on screen, select **Update** and follow the instructions on screen.

You can also look for a software update yourself.

During the software update, there is no picture and the TV will switch off and on again. This might happen several times. The update can take a few minutes. Wait until the TV picture comes back up. Do not press the power switch  on the TV or on the remote control during the software update.

To look for a software update yourself...

- 1 - Press , select **All Settings** and press **OK**.
- 2 - Select **Update Software > Search for Updates** and press **OK**.
- 3 - Select **Internet** and press **OK**.
- 4 - The TV will look for an update on the Internet.
- 5 - If an update is available, you can update the software right away.
- 6 - A software update can take several minutes. Do not press the  key on the TV or remote control.
- 7 - When the update is done, the TV will return to the channel you were watching.

Update from USB

It might be necessary to update the TV software. You need a computer with an high-speed Internet connection and a USB flash drive to upload the software on the TV. Use a USB flash drive with at least 500MB free space. Make sure that write protection is switched off.

To update the TV software...

- 1 - Press , select **All Settings** and press **OK**.
- 2 - Select **Update Software > Search for Updates** and press **OK**.
- 3 - Select **USB** and press **OK**.

Identify the TV

- 1 - Insert the USB flash drive into one of the USB connections of the TV.
- 2 - Select **Write to USB** and press **OK**. An identification file is written on the USB flash drive.

Download the software

- 1 - Insert the USB flash drive into your computer.
- 2 - On the USB flash drive, locate the file **update.htm** and double click it.
- 3 - Click **Send ID**.
- 4 - If new software is available, download the .zip file.
- 5 - After the download, unzip the file and copy the file **autorun.upg** onto the USB flash drive. Do not place this file in a folder.

Update the TV software

- 1 - Insert the USB flash drive into the TV again. The update starts automatically.
- 2 - A software update can take several minutes. Do not press the  key on the TV or remote control. Do not remove the USB flash drive.
- 3 - When the update is done, the TV will return to the channel you were watching.



If a power cut occurs during the update, never remove the USB flash drive from the TV. When the power returns, the update will continue.

To prevent an accidental update of the TV software, delete the autorun.upg file from the USB flash drive.

26.2

Software Version

To view the current TV software version...

- 1 - Press , select **All Settings** and press **OK**.
- 2 - Select **Update Software > Current Software Info** and press **OK**.
- 3 - The version, release notes and creation date are shown.
- 4 - Press  (left) repeatedly if necessary, to close the menu.

26.3

Open Source Software

This television contains open source software. TP Vision Europe B.V. hereby offers to deliver, upon request, a copy of the complete corresponding source code for the copyrighted open source software packages used in this product for which such offer is requested by the respective licences.

This offer is valid up to three years after product purchase to anyone in receipt of this information. To obtain the source code, please write in English to .

...

Intellectual Property Dept.
 TP Vision Europe B.V.
 Prins Bernhardplein 200
 1097 JB Amsterdam
 The Netherlands

Open Source License

README for the source code of the parts of TP Vision Netherlands B.V. TV software that fall under open source licenses.

This is a document describing the distribution of the source code used on the TP Vision Netherlands B.V. TV, which fall either under the GNU General Public License (the GPL), or the GNU Lesser General Public License (the LGPL), or any other open source license. Instructions to obtain copies of this software can be found in the Directions For Use.

TP Vision Netherlands B.V. MAKES NO WARRANTIES WHATSOEVER, EITHER EXPRESS OR IMPLIED, INCLUDING ANY WARRANTIES OF MERCHANTABILITY OR FITNESS FOR A PARTICULAR PURPOSE, REGARDING THIS SOFTWARE. TP Vision Netherlands B.V. offers no support for this software. The preceding does not affect your warranties and statutory rights regarding any TP Vision Netherlands B.V. product(s) you purchased. It only applies to this source code made available to you.

Android (5.1.0)

This TV contains the Android Lollipop Software. Android is a Linux-based operating system designed primarily for touch screen mobile devices such as smartphones and tablet computers. This software will also be reused in TPVision Android based TV's. The original download site for this software is : <https://android.googlesource.com/>This piece of software is made available under the terms and conditions of the Apache license version 2, which can be found below. Android APACHE License Version 2 (<http://source.android.com/source/licenses.html>)

Toolbox (N/A)

The original download site for this software is : <https://android.googlesource.com/>This piece of software is made available under the terms and conditions of the Apache license version 2, which can be found below. Android APACHE License Version 2 (<http://source.android.com/source/licenses.html>)

linux kernel (3.10.27)

This TV contains the Linux Kernel. The original download site for this software is : <http://www.kernel.org/>.This piece of software is made available under the terms and conditions of the GPL v2 license, which can be found below. Additionally, following exception applies : "NOTE! This copyright does *not* cover user programs that use kernel services by normal system calls - this is merely considered normal use of the kernel, and does *not* fall under the heading of "derived work". Also note

that the GPL below is copyrighted by the Free Software Foundation, but the instance of code that it refers to (the linux kernel) is copyrighted by me and others who actually wrote it. Also note that the only valid version of the GPL as far as the kernel is concerned is `_this_` particular version of the license (ie v2, not v2.2 or v3.x or whatever), unless explicitly otherwise stated. Linus Torvalds"

libcurl (7.21.7)

libcurl is a free and easy-to-use client-side URL transfer library, supporting DICT, FILE, FTP, FTPS, Gopher, HTTP, HTTPS, IMAP, IMAPS, LDAP, LDAPS, POP3, POP3S, RTMP, RTSP, SCP, SFTP, SMTP, SMTPS, Telnet and TFTP. libcurl supports SSL certificates, HTTP POST, HTTP PUT, FTP uploading, HTTP form based upload, proxies, cookies, user+password authentication (Basic, Digest, NTLM, Negotiate, Kerberos), file transfer resume, http proxy tunneling and more! The original download site for this software is : [http://curl.haxx.se/libcurl/COPYRIGHT AND PERMISSION NOTICE](http://curl.haxx.se/libcurl/COPYRIGHT%20AND%20PERMISSION%20NOTICE)

Copyright (c) 1996 - 2010, Daniel Stenberg, daniel@haxx.se. All rights reserved. Permission to use, copy, modify, and distribute this software for any purpose with or without fee is hereby granted, provided that the above copyright notice and this permission notice appear in all copies. THE SOFTWARE IS PROVIDED "AS IS", WITHOUT WARRANTY OF ANY KIND, EXPRESS OR IMPLIED, INCLUDING BUT NOT LIMITED TO THE WARRANTIES OF MERCHANTABILITY, FITNESS FOR A PARTICULAR PURPOSE AND NONINFRINGEMENT OF THIRD PARTY RIGHTS. IN NO EVENT SHALL THE AUTHORS OR COPYRIGHT HOLDERS BE LIABLE FOR ANY CLAIM, DAMAGES OR OTHER LIABILITY, WHETHER IN AN ACTION OF CONTRACT, TORT OR OTHERWISE, ARISING FROM, OUT OF OR IN CONNECTION WITH THE SOFTWARE OR THE USE OR OTHER DEALINGS IN THE SOFTWARE. Except as contained in this notice, the name of a copyright holder shall not be used in advertising or otherwise to promote the sale, use or other dealings in this Software without prior written authorization of the copyright holder.

libfreetype (2.4.2)

FreeType is a software development library, available in source and binary forms, used to render text on to bitmaps and provides support for other font-related operations

The original download site for this software is : <https://github.com/julienr/libfreetype-android>FreeType License

libjpeg (8a)

This package contains C software to implement JPEG image encoding, decoding, and transcoding. This software is based in part on the work of the Independent JPEG Group.

The authors make NO WARRANTY or representation, either express or implied, with respect to this software, its quality, accuracy, merchantability, or fitness for a particular purpose. This software is provided "AS IS", and you, its user, assume the entire risk as to its quality and accuracy. This software is copyright (C) 1991-1998, Thomas G. Lane. All Rights Reserved except as specified below. Permission is hereby granted to use, copy, modify, and distribute this software (or portions thereof) for any purpose, without fee, subject to these conditions:(1) If any part of the source code for this software is distributed, then this README file must be included, with this copyright and no-warranty notice unaltered; and any additions, deletions, or changes to the original files must be clearly indicated in accompanying documentation.(2) If only executable code is distributed, then the accompanying documentation must state that "this software is based in part on the work of the Independent JPEG Group".(3) Permission for use of this software is granted only if the user accepts full responsibility for any undesirable consequences; the authors accept NO LIABILITY for damages of any kind. These conditions apply to any software derived from or based on the IJG code, not just to the unmodified library. If you use our work, you ought to acknowledge us. Permission is NOT granted for the use of any IJG author's name or company name in advertising or publicity relating to this software or products derived from it. This software may be referred to only as "the Independent JPEG Group's software". We specifically permit and encourage the use of this software as the basis of commercial products, provided that all warranty or liability claims are assumed by the product vendor.

libpng (1.4.1)

libpng is the official Portable Network Graphics (PNG) reference library (originally called pnglib). It is a platform-independent library that contains C functions for handling PNG images. It supports almost all of PNG's features, is extensible. The original download site for this software is : <https://github.com/julienr/libpng-androidlibpng> license

openssl (1.0.1j)

OpenSSL is an open-source implementation of the SSL and TLS protocols. The core library, written in the C programming language, implements the basic cryptographic functions and provides various utility

functions. The original download site for this software is : <http://openssl.org/OpenSSL> license

Zlib compression library (1.2.7)

zlib is a general purpose data compression library. All the code is thread safe. The data format used by the zlib library is described by RFCs (Request for Comments) 1950 to 1952 in the files <http://tools.ietf.org/html/rfc1950> (zlib format), rfc1951 (deflate format) and rfc1952 (gzip format) Developed by Jean-loup Gailly and Mark Adler(C) 1995-2012 Jean-loup Gailly and Mark Adler This software is provided 'as-is', without any express or implied warranty. In no event will the authors be held liable for any damages arising from the use of this software. Permission is granted to anyone to use this software for any purpose, including commercial applications, and to alter it and redistribute it freely, subject to the following restrictions: 1. The origin of this software must not be misrepresented; you must not claim that you wrote the original software. If you use this software in a product, an acknowledgment in the product documentation would be appreciated but is not required. 2. Altered source versions must be plainly marked as such, and must not be misrepresented as being the original software. 3. This notice may not be removed or altered from any source distribution. Jean-loup Gailly Mark Adler jloup@gzip.org madler@alumni.caltech.edu

dvbsnoop (1.2)

dvbsnoop is a DVB / MPEG stream analyzer program. For generating CRC32 values required for composing PAT, PMT, EIT sections

The original download site for this software is : <https://github.com/a4tunado/dvbsnoop/blob/master/src/misc/crc32.c>GPL v2 <http://dvbsnoop.sourceforge.net/dvbsnoop.html>

ezxml (0.8.6)

ezXML is a C library for parsing XML documents.

The original download site for this software is : <http://ezxml.sourceforge.net>. Copyright 2004, 2005 Aaron Voisine. This piece of software is made available under the terms and conditions of the MIT license, which can be found below.

gSoap (2.7.15)

The gSOAP toolkit is an open source C and C++ software development toolkit for SOAP/XML Web services and generic (non-SOAP) C/C++ XML data bindings. Part of the software embedded in this product is gSOAP software. Portions created by

gSOAP are Copyright 2001-2009 Robert A. van Engelen, Genivia inc. All Rights Reserved. THE SOFTWARE IN THIS PRODUCT WAS IN PART PROVIDED BY GENIVIA INC AND ANY EXPRESS OR IMPLIED WARRANTIES, INCLUDING, BUT NOT LIMITED TO, THE IMPLIED WARRANTIES OF MERCHANTABILITY AND FITNESS FOR A PARTICULAR PURPOSE ARE DISCLAIMED. IN NO EVENT SHALL THE AUTHOR BE LIABLE FOR ANY DIRECT, INDIRECT, INCIDENTAL, SPECIAL, EXEMPLARY, OR CONSEQUENTIAL DAMAGES (INCLUDING, BUT NOT LIMITED TO, PROCUREMENT OF SUBSTITUTE GOODS OR SERVICES; LOSS OF USE, DATA, OR PROFITS; OR BUSINESS INTERRUPTION) HOWEVER CAUSED AND ON ANY THEORY OF LIABILITY, WHETHER IN CONTRACT, STRICT LIABILITY, OR TORT (INCLUDING NEGLIGENCE OR OTHERWISE) ARISING IN ANY WAY OUT OF THE USE OF THIS SOFTWARE, EVEN IF ADVISED OF THE POSSIBILITY OF SUCH DAMAGE.

restlet (2.1.7)

Restlet is a lightweight, comprehensive, open source REST framework for the Java platform. Rest let is suitable for both server and client Web applications. It supports major Internet transport, data format, and service description standards like HTTP and HTTPS, SMTP, XML, JSON, Atom, and WADL. The original download site for this software is :

<http://restlet.org>This piece of software is made available under the terms and conditions of the Apache License version 2.

Opera Web Browser (SDK 3.5)

This TV contains Opera Browser Software.

dlmalloc (2.7.2)

Opera uses Doug Lea's memory allocator

The original download site for this software is :

<http://gee.cs.oswego.edu/dl/html/malloc.html>

double-conversion

Opera uses double-conversion library by Florian Loitsch, faster double : string conversions (dtoa and strtod).The original download site for this software is : <http://code.google.com/p/double-conversion>Copyright 2006-2011, the V8 project authors. All rights reserved. Redistribution and use in source and binary forms, with or without modification, are permitted provided that the following conditions are met: * Redistributions of source code must retain the above copyright notice, this list of conditions and the following disclaimer. * Redistributions in binary form must reproduce the above copyright notice, this

list of conditions and the following disclaimer in the documentation and/or other materials provided with the distribution. * Neither the name of Google Inc. nor the names of its contributors may be used to endorse or promote products derived from this software without specific prior written permission. THIS SOFTWARE IS PROVIDED BY THE COPYRIGHT HOLDERS AND CONTRIBUTORS "AS IS" AND ANY EXPRESS OR IMPLIED WARRANTIES, INCLUDING, BUT NOT LIMITED TO, THE IMPLIED WARRANTIES OF MERCHANTABILITY AND FITNESS FOR A PARTICULAR PURPOSE ARE DISCLAIMED. IN NO EVENT SHALL THE COPYRIGHT OWNER OR CONTRIBUTORS BE LIABLE FOR ANY DIRECT, INDIRECT, INCIDENTAL, SPECIAL, EXEMPLARY, OR CONSEQUENTIAL DAMAGES (INCLUDING, BUT NOT LIMITED TO, PROCUREMENT OF SUBSTITUTE GOODS OR SERVICES; LOSS OF USE, DATA, OR PROFITS; OR BUSINESS INTERRUPTION) HOWEVER CAUSED AND ON ANY THEORY OF LIABILITY, WHETHER IN CONTRACT, STRICT LIABILITY, OR TORT (INCLUDING NEGLIGENCE OR OTHERWISE) ARISING IN ANY WAY OUT OF THE USE OF THIS SOFTWARE, EVEN IF ADVISED OF THE POSSIBILITY OF SUCH DAMAGE.

EMX (0.9c)

Opera uses EMX, which is an OS/2 port of the gcc suite. Opera uses modified versions of the sprintf and sscanf methods from this C library.* The emx libraries are not distributed under the GPL. Linking an * application with the emx libraries does not cause the executable * to be covered by the GNU General Public License. You are allowed * to change and copy the emx library sources if you keep the copyright * message intact. If you improve the emx libraries, please send your * enhancements to the emx author (you should copyright your * enhancements similar to the existing emx libraries).

freetype (2.4.8)

Opera uses freetype FreeType 2 is a software-font engine that is designed to be small, efficient, highly customizable and portable, while capable of producing high-quality output (glyph images).The original download site for this software is : <http://www.freetype.org/freetype2/index.html>Freeware License

HKSCS (2008)

Opera uses HKSCS: The Government of the Hong Kong Special Administrative Region HKSCS mappingsThe original download site for this software is : <http://www.ogcio.gov.hk>Before downloading the Software or Document provided on this Web page, you should read the following terms (Terms of Use). By downloading the Software and Document, you are

deemed to agree to these terms.1. The Government of the Hong Kong Special Administrative Region (HKSARG) has the right to amend or vary the terms under this Terms of Use from time to time at its sole discretion.2. By using the Software and Document, you irrevocably agree that the HKSARG may from time to time vary this Terms of Use without further notice to you and you also irrevocably agree to be bound by the most updated version of the Terms of Use.3. You have the sole responsibility of obtaining the most updated version of the Terms of Use which is available in the "Digital 21" Web site (http://www.ogcio.gov.hk/en/business/tech_promotion/ccli/terms/terms.htm).4. By accepting this Terms of Use, HKSARG shall grant you a non-exclusive license to use the Software and Document for any purpose, subject to clause 5 below.5. You are not allowed to make copies of the Software and Document except it is incidental to and necessary for the normal use of the Software. You are not allowed to adapt or modify the Software and Document or to distribute, sell, rent, or make available to the public the Software and Document, including copies or an adaptation of them.6. The Software and Document are protected by copyright. The licensors of the Government of Hong Kong Special Administrative Region are the owners of all copyright works in the Software and Document. All rights reserved.7. You understand and agree that use of the Software and Document are at your sole risk, that any material and/or data downloaded or otherwise obtained in relation to the Software and Document is at your discretion and risk and that you will be solely responsible for any damage caused to your computer system or loss of data or any other loss that results from the download and use of the Software and Document in any manner whatsoever.8. In relation to the Software and Document, HKSARG hereby disclaims all warranties and conditions, including all implied warranties and conditions of merchantability, fitness for a particular purpose and non-infringement.9. HKSARG will not be liable for any direct, indirect, incidental, special or consequential loss of any kind resulting from the use of or the inability to use the Software and Document even if HKSARG has been advised of the possibility of such loss.10. You agree not to sue HKSARG and agree to indemnify, defend and hold harmless HKSARG, its officers and employees from any and all third party claims, liability, damages and/or costs (including, but not limited to, legal fees) arising from your use of the Software and Document, your violation of the Terms of Use or infringement of any intellectual property or other right of any person or entity.11. The Terms of Use will be governed by and construed in accordance with the laws of Hong Kong.12. Any waiver of any provision of the Terms of Use will be effective only if in writing and signed by HKSARG or its representative.13. If for any reason a court of competent jurisdiction finds any provision or portion of the Terms of Use to be unenforceable, the

remainder of the Terms of Use will continue in full force and effect.14. The Terms of Use constitute the entire agreement between the parties with respect to the subject matter hereof and supersedes and replaces all prior or contemporaneous understandings or agreements, written or oral, regarding such subject matter.15. In addition to the licence granted in Clause 4, HKSARG hereby grants you a non-exclusive limited licence to reproduce and distribute the Software and Document with the following conditions:(i) not for financial gain unless it is incidental;(ii) reproduction and distribution of the Software and Document in complete and unmodified form; and(iii) when you distribute the Software and Document, you agree to attach the Terms of Use and a statement that the latest version of the Terms of Use is available from the "Office of the Government Chief Information Officer" Web site (http://www.ogcio.gov.hk/en/business/tech_promotion/ccli/terms/terms.htm).

IANA (Dec 30 2013)

Opera uses Internet Assigned Numbers Authority: Character encoding tag names and numbers. The original download site for this software is : <https://www.iana.org>

ICU (3)

Opera uses ICU : International Components for Unicode: Mapping table for GB18030The original download site for this software is : <http://site.icu-project.org/http://source.icu-project.org/repos/icu/icu/trunk/license.html>

MozTW (1.0)

Opera uses MoxTW : MozTW project: Big5-2003 mapping tables. The original download site for this software is : <https://moztw.org>This piece of software is made available under the terms and conditions of CCPL

NPAPI (0.27)

Opera uses NPAPI : Netscape 4 Plugin API: npapi.h, npfunctions.h, npruntime.h and nptypes.h. Distributed as part of the Netscape 4 Plugin SDK.The original download site for this software is : wiki.mozilla.orgThis piece of software is made available under the terms and conditions of mozilla licence as described below.

Unicode (4.0)

Opera uses Unicode : Data from the Unicode character database. The original download site for

this software is : [www.unicode.orghttp://www.unicode.org/copyright.html](http://www.unicode.org/http://www.unicode.org/copyright.html)

Webp (0.2.0)

Opera uses Webp : libwebp is a library for decoding images in the WebP format. Products may use it to decode WebP images. The turbo servers will eventually re-decode images to WebP. The original download site for this software is : <https://developers.google.com/speed/webp/?csw=1> <https://chromium.googlesource.com/webm/libwebp/> Additional IP Rights Grant (Patents)"This implementation" means the copyrightable works distributed by Google as part of the WebM Project. Google hereby grants to you a perpetual, worldwide, non-exclusive, no-charge, royalty-free, irrevocable (except as stated in this section) patent license to make, have made, use, offer to sell, sell, import, transfer, and otherwise run, modify and propagate the contents of this implementation of VP8, where such license applies only to those patent claims, both currently owned by Google and acquired in the future, licensable by Google that are necessarily infringed by this implementation of VP8. This grant does not include claims that would be infringed only as a consequence of further modification of this implementation. If you or your agent or exclusive licensee institute or order or agree to the institution of patent litigation against any entity (including a cross-claim or counterclaim in a lawsuit) alleging that this implementation of VP8 or any code incorporated within this implementation of VP8 constitutes direct or contributory patent infringement, or inducement of patent infringement, then any patent rights granted to you under this License for this implementation of VP8 shall terminate as of the date such litigation is filed.

FaceBook SDK (3.0.1)

This TV contains Facebook SDK. The Facebook SDK for Android is the easiest way to integrate your Android app with Facebook's platform. The SDK provides support for Login with Facebook authentication, reading and writing to Facebook APIs and support for UI elements such as pickers and dialogs. The original download site for this software is : <https://developer.facebook.com/docs/android> This piece of software is made available under the terms and conditions of the Apache License version 2.

iptables (1.4.7)

iptables is a user space application program that allows a system administrator to configure the tables provided by the Linux kernel firewall (implemented as different Netfilter modules) and the chains and rules it stores. Different kernel modules and programs are

currently used for different protocols; iptables applies to IPv4. The original download site for this software is : <https://android.googlesource.com> This piece of software is made available under the terms and conditions of the GPL v2.

libyuv (814)

libyuv is an open source project that includes YUV conversion and scaling functionality. The original download site for this software is : <http://code.google.com/p/libyuv> This piece of software is made available under the terms and conditions BSD.

ffmpeg (2.1.3)

This TV uses FFmpeg. FFmpeg is a complete, cross-platform solution to record, convert and stream audio and video. The original download site for this software is : <http://ffmpeg.org> This piece of software is made available under the terms and conditions of the GPL v2 license, which can be found below.

u-boot (2011-12)

U-boot is a boot loader for embedded boards based on ARM, MIPS and other processors, which can be installed in a boot ROM and used to initialize and test the hardware or to download and run application code

This piece of software is made available under the terms and conditions of the GPL v2 license, which can be found below.

live555 (0.82)

Live555 provides RTP/RTCP/RTSP client. The original download site for this software is : <http://www.live555.com> This piece of software is made available under the terms and conditions of the LGPL v2.1 license, which can be found below.

Bluetooth Stack (Bluedroid)

This TV uses Bluetooth stack. The original download site for this software is : This piece of software is made available under the terms and conditions of Android Apache License Version 2.

EXIF (NA)

Exif JPEG header manipulation tool. The original download site for this software is : <http://www.sentex.net/~mwandel/jhead/> Portions of this source code are in the public domain

Copyright (c) 2008, The Android Open Source Project

All rights reserved. Redistribution and use in source and binary forms, with or without modification, are permitted provided that the following conditions are met: * Redistributions of source code must retain the above copyright notice, this list of conditions and the following disclaimer. * Redistributions in binary form must reproduce the above copyright notice, this list of conditions and the following disclaimer in the documentation and/or other materials provided with the distribution. * Neither the name of The Android Open Source Project nor the names of its contributors may be used to endorse or promote products derived from this software without specific prior written permission. THIS SOFTWARE IS PROVIDED BY THE COPYRIGHT HOLDERS AND CONTRIBUTORS "AS IS" AND ANY EXPRESS OR IMPLIED WARRANTIES, INCLUDING, BUT NOT LIMITED TO, THE IMPLIED WARRANTIES OF MERCHANTABILITY AND FITNESS FOR A PARTICULAR PURPOSE ARE DISCLAIMED. IN NO EVENT SHALL THE COPYRIGHT OWNER OR CONTRIBUTORS BE LIABLE FOR ANY DIRECT, INDIRECT, INCIDENTAL, SPECIAL, EXEMPLARY, OR CONSEQUENTIAL DAMAGES (INCLUDING, BUT NOT LIMITED TO, PROCUREMENT OF SUBSTITUTE GOODS OR SERVICES; LOSS OF USE, DATA, OR PROFITS; OR BUSINESS INTERRUPTION) HOWEVER CAUSED AND ON ANY THEORY OF LIABILITY, WHETHER IN CONTRACT, STRICT LIABILITY, OR TORT (INCLUDING NEGLIGENCE OR OTHERWISE) ARISING IN ANY WAY OUT OF THE USE OF THIS SOFTWARE, EVEN IF ADVISED OF THE POSSIBILITY OF SUCH DAMAGE.

EXPAT (2.1.0)

EXPAT is a XML Parser. The original download site for this software is : <http://expat.sourceforge.net> Copyright (c) 1998, 1999, 2000 Thai Open Source Software Center Ltd and Clark Cooper

Copyright (c) 2001, 2002, 2003, 2004, 2005, 2006 Expat maintainers. Permission is hereby granted, free of charge, to any person obtaining a copy of this software and associated documentation files (the "Software"), to deal in the Software without restriction, including without limitation the rights to use, copy, modify, merge, publish, distribute, sublicense, and/or sell copies of the Software, and to permit persons to whom the Software is furnished to do so, subject to the following conditions: The above copyright notice and this permission notice shall be included in all copies or substantial portions of the Software. THE SOFTWARE IS PROVIDED "AS IS", WITHOUT WARRANTY OF ANY KIND, EXPRESS OR IMPLIED, INCLUDING BUT NOT LIMITED TO THE WARRANTIES OF MERCHANTABILITY, FITNESS FOR A PARTICULAR PURPOSE AND NONINFRINGEMENT. IN NO EVENT SHALL THE AUTHORS OR COPYRIGHT HOLDERS BE LIABLE FOR ANY CLAIM, DAMAGES OR

OTHER LIABILITY, WHETHER IN AN ACTION OF CONTRACT, TORT OR OTHERWISE, ARISING FROM, OUT OF OR IN CONNECTION WITH THE SOFTWARE OR THE USE OR OTHER DEALINGS IN THE SOFTWARE.

neven face recognition library (NA)

This TV uses neven face recognition library which is used for face recognition This piece of software is made available under the terms and conditions of Android Apache License version 2.

Unicode (4.8.1.1)

This TV uses Unicode which specifies the representation of text

The original download site for this software is : <http://icu-project.org> ICU License - ICU 1.8.1 and later

COPYRIGHT AND PERMISSION NOTICE

Copyright (c) 1995-2008 International Business Machines Corporation and others

All rights reserved. Permission is hereby granted, free of charge, to any person obtaining a copy of this software and associated documentation files (the "Software"), to deal in the Software without restriction, including without limitation the rights to use, copy, modify, merge, publish, distribute, and/or sell copies of the Software, and to permit persons to whom the Software is furnished to do so, provided that the above copyright notice(s) and this permission notice appear in all copies of the Software and that both the above copyright notice(s) and this permission notice appear in supporting documentation. THE SOFTWARE IS PROVIDED "AS IS", WITHOUT WARRANTY OF ANY KIND, EXPRESS OR IMPLIED, INCLUDING BUT NOT LIMITED TO THE WARRANTIES OF MERCHANTABILITY, FITNESS FOR A PARTICULAR PURPOSE AND NONINFRINGEMENT OF THIRD PARTY RIGHTS. IN NO EVENT SHALL THE COPYRIGHT HOLDER OR HOLDERS INCLUDED IN THIS NOTICE BE LIABLE FOR ANY CLAIM, OR ANY SPECIAL INDIRECT OR CONSEQUENTIAL DAMAGES, OR ANY DAMAGES WHATSOEVER RESULTING FROM LOSS OF USE, DATA OR PROFITS, WHETHER IN AN ACTION OF CONTRACT, NEGLIGENCE OR OTHER TORTIOUS ACTION, ARISING OUT OF OR IN CONNECTION WITH THE USE OR PERFORMANCE OF THIS SOFTWARE. Except as contained in this notice, the name of a copyright holder shall not be used in advertising or otherwise to promote the sale, use or other dealings in this Software without prior written authorization of the copyright holder. All trademarks and registered trademarks mentioned herein are the property of their respective owners.

IPRoute2 (NA)

IPRoute2 is used for TCP/IP, Networking and Traffic control. The original download site for this software is : <http://www.linuxfoundation.org/collaborate/workgroups/networking/iproute2>This piece of software is made available under the terms and conditions of GPL V2.

mtpd (NA)

mtpd is used for VPN Network. The original download site for this software is : <http://libmtp.sourceforge.net/>This piece of software is made available under the terms and conditions of Apache License version 2.0.

MDNS Responder (NA)

MDNS Responder. The Mdns Responder project is a component of Bonjour, Apple's ease-of-use IP networking initiative. The original download site for this software is : <http://www.opensource.apple.com/tarballs/mDNSResponder/>This piece of software is made available under the terms and conditions of Apache License version 2.0.

NFC (NA)

NFC Semiconductor's NFC Library. Near Field Communication (NFC) is a set of short-range wireless technologies, typically requiring a distance of 4cm or less to initiate a connection. NFC allows you to share small payloads of data between an NFC tag and an Android-powered device, or between two Android-powered devices. This piece of software is made available under the terms and conditions of Apache License version 2.0.

Skia (NA)

Skia is a complete 2D graphic library for drawing Text, Geometries, and Images. The original download site for this software is : <http://code.google.com/p/skia/>Copyright (c) 2011 Google Inc. All rights reserved. Redistribution and use in source and binary forms, with or without modification, are permitted provided that the following conditions are met: * Redistributions of source code must retain the above copyright notice, this list of conditions and the following disclaimer. * Redistributions in binary form must reproduce the above copyright notice, this list of conditions and the following disclaimer in the documentation and/or other materials provided with the distribution. * Neither the name of Google Inc. nor the names of its contributors may be used to endorse or promote products derived from this software without specific prior written permission. THIS SOFTWARE IS

PROVIDED BY THE COPYRIGHT HOLDERS AND CONTRIBUTORS "AS IS" AND ANY EXPRESS OR IMPLIED WARRANTIES, INCLUDING, BUT NOT LIMITED TO, THE IMPLIED WARRANTIES OF MERCHANTABILITY AND FITNESS FOR A PARTICULAR PURPOSE ARE DISCLAIMED. IN NO EVENT SHALL THE COPYRIGHT OWNER OR CONTRIBUTORS BE LIABLE FOR ANY DIRECT, INDIRECT, INCIDENTAL, SPECIAL, EXEMPLARY, OR CONSEQUENTIAL DAMAGES (INCLUDING, BUT NOT LIMITED TO, PROCUREMENT OF SUBSTITUTE GOODS OR SERVICES; LOSS OF USE, DATA, OR PROFITS; OR BUSINESS INTERRUPTION) HOWEVER CAUSED AND ON ANY THEORY OF LIABILITY, WHETHER IN CONTRACT, STRICT LIABILITY, OR TORT (INCLUDING NEGLIGENCE OR OTHERWISE) ARISING IN ANY WAY OUT OF THE USE OF THIS SOFTWARE, EVEN IF ADVISED OF THE POSSIBILITY OF SUCH DAMAGE.

Sonic Audio Synthesis library (NA)

The original download site for this software is : <http://www.sonivoxmi.com/>This piece of software is made available under the terms and conditions of Apache License version 2.0.

Sqlite (3071100)

The original download site for this software is : www.sqlite.org.This piece of software is made available under the terms and conditions of Apache License version 2.0.

Nuance Speech Recognition engine (NA)

The original download site for this software is : <http://www.nuance.com/>This piece of software is made available under the terms and conditions of Apache License version 2.0.

C++Standard Template Library library (5)

This TV uses Implementation of the C++ Standard Template Library. The original download site for this software is : <http://stlport.sourceforge.net>Boris Fomitchev grants Licensee a non-exclusive, non-transferable, royalty-free license to use STLport and its documentation without fee. By downloading, using, or copying STLport or any portion thereof, Licensee agrees to abide by the intellectual property laws and all other applicable laws of the United States of America, and to all of the terms and conditions of this Agreement. Licensee shall maintain the following copyright and permission notices on STLport sources and its documentation unchanged :Copyright 1999,2000 Boris Fomitchev

This material is provided "as is", with absolutely no

warranty expressed or implied. Any use is at your own risk. Permission to use or copy this software for any purpose is hereby granted without fee, provided the above notices are retained on all copies. Permission to modify the code and to distribute modified code is granted, provided the above notices are retained, and a notice that the code was modified is included with the above copyright notice. The Licensee may distribute binaries compiled with STLport (whether original or modified) without any royalties or restrictions. The Licensee may distribute original or modified STLport sources, provided that: The conditions indicated in the above permission notice are met; The following copyright notices are retained when present, and conditions provided in accompanying permission notices are met :Copyright 1994 Hewlett-Packard Company Copyright 1996,97 Silicon Graphics Computer Systems, Inc. Copyright 1997 Moscow Center for SPARC Technology. Permission to use, copy, modify, distribute and sell this software and its documentation for any purpose is hereby granted without fee, provided that the above copyright notice appear in all copies and that both that copyright notice and this permission notice appear in supporting documentation. Hewlett-Packard Company makes no representations about the suitability of this software for any purpose. It is provided "as is" without express or implied warranty. Permission to use, copy, modify, distribute and sell this software and its documentation for any purpose is hereby granted without fee, provided that the above copyright notice appear in all copies and that both that copyright notice and this permission notice appear in supporting documentation. Silicon Graphics makes no representations about the suitability of this software for any purpose. It is provided "as is" without express or implied warranty. Permission to use, copy, modify, distribute and sell this software and its documentation for any purpose is hereby granted without fee, provided that the above copyright notice appear in all copies and that both that copyright notice and this permission notice appear in supporting documentation. Moscow Center for SPARC Technology makes no representations about the suitability of this software for any purpose. It is provided "as is" without express or implied warranty

svox (NA)

The original download site for this software is :
<http://www.nuance.com/>This piece of software is made available under the terms and conditions of Apache License version 2.0.

tinyalsa (NA)

This TV uses tinyalsa: a small library to interface with ALSA in the Linux kernel The original download site for this software is :

<http://github.com/tinyalsa>Copyright 2011, The Android Open Source Project Redistribution and use in source and binary forms, with or without modification, are permitted provided that the following conditions are met: * Redistributions of source code must retain the above copyright notice, this list of conditions and the following disclaimer. * Redistributions in binary form must reproduce the above copyright notice, this list of conditions and the following disclaimer in the documentation and/or other materials provided with the distribution. * Neither the name of The Android Open Source Project nor the names of its contributors may be used to endorse or promote products derived from this software without specific prior written permission. THIS SOFTWARE IS PROVIDED BY The Android Open Source Project "AS IS" AND ANY EXPRESS OR IMPLIED WARRANTIES, INCLUDING, BUT NOT LIMITED TO, THE IMPLIED WARRANTIES OF MERCHANTABILITY AND FITNESS FOR A PARTICULAR PURPOSE ARE DISCLAIMED. IN NO EVENT SHALL The Android Open Source Project BE LIABLE FOR ANY DIRECT, INDIRECT, INCIDENTAL, SPECIAL, EXEMPLARY, OR CONSEQUENTIAL DAMAGES (INCLUDING, BUT NOT LIMITED TO, PROCUREMENT OF SUBSTITUTE GOODS OR SERVICES; LOSS OF USE, DATA, OR PROFITS; OR BUSINESS INTERRUPTION) HOWEVER CAUSED AND ON ANY THEORY OF LIABILITY, WHETHER IN CONTRACT, STRICT LIABILITY, OR TORT (INCLUDING NEGLIGENCE OR OTHERWISE) ARISING IN ANY WAY OUT OF THE USE OF THIS SOFTWARE, EVEN IF ADVISED OF THE POSSIBILITY OF SUCH DAMAGE.

Vorbis Decompression Library (NA)

This TV uses Tremolo ARM-optimized Ogg Vorbis decompression library. Vorbis is a general purpose audio and music encoding format contemporary to MPEG-4's AAC and TwinVQ, the next generation beyond MPEG audio layer 3 The original download site for this software is :

<http://wss.co.uk/pinknoise/tremo>Copyright (c) 2002-2008 Xiph.org Foundation Redistribution and use in source and binary forms, with or without modification, are permitted provided that the following conditions are met:- Redistributions of source code must retain the above copyright notice, this list of conditions and the following disclaimer.- Redistributions in binary form must reproduce the above copy right notice, this list of conditions and the following disclaimer in the documentation and/or other materials provided with the distribution.- Neither the name of the Xiph.org Foundation nor the names of its contributors may be used to endorse or promote products derived from this software without specific prior written permission. THIS SOFTWARE IS PROVIDED BY THE COPYRIGHT HOLDERS AND

CONTRIBUTORS "AS IS" AND ANY EXPRESS OR IMPLIED WARRANTIES, INCLUDING, BUT NOT LIMITED TO, THE IMPLIED WARRANTIES OF MERCHANTABILITY AND FITNESS FOR A PARTICULAR PURPOSE ARE DISCLAIMED. IN NO EVENT SHALL THE FOUNDATION OR CONTRIBUTORS BE LIABLE FOR ANY DIRECT, INDIRECT, INCIDENTAL, SPECIAL, EXEMPLARY, OR CONSEQUENTIAL DAMAGES (INCLUDING, BUT NOT LIMITED TO, PROCUREMENT OF SUBSTITUTE GOODS OR SERVICES; LOSS OF USE, DATA, OR PROFITS; OR BUSINESS INTERRUPTION) HOWEVER CAUSED AND ON ANY THEORY OF LIABILITY, WHETHER IN CONTRACT, STRICT LIABILITY, OR TORT (INCLUDING NEGLIGENCE OR OTHERWISE) ARISING IN ANY WAY OUT OF THE USE OF THIS SOFTWARE, EVEN IF ADVISED OF THE POSSIBILITY OF SUCH DAMAGE.

wpa_supplicant_Daemon (v0.8)

Library used by legacy HAL to talk to wpa_supplicant daemon. The original download site for this software is : http://hostap.epitest.fi/wpa_supplicant/ This piece of software is made available under the terms and conditions of GPL version 2.

gson (2.3)

Gson is a Java library that can be used to convert Java Objects into their JSON representation. It can also be used to convert a JSON string to an equivalent Java object. Gson can work with arbitrary Java objects including pre-existing objects that you do not have source-code of. The original download site for this software is : <https://code.google.com/p/google-gson/> This piece of software is made available under the terms and conditions of the Apache License 2.0

This software includes an implementation of the AES Cipher, licensed by Brian Gladman

The original download site for this software is : <http://www.gladman.me.uk/> This piece of software is licensed by Brian Gladman

libUpNp (1.2.1)

The original download site for this software is : <http://upnp.sourceforge.net/> This piece of software is made available under the terms and conditions of the BSD.

dnsmasq

Dnsmasq is a lightweight, easy to configure DNS forwarder and DHCP server

The original download site for this software is : <https://android.googlesource.com/platform/external/dnsmasq> This piece of software is made available under the terms and conditions of the GPL v2 license, which can be found below.

TomCrypt (1.1)

iwedia stack is using tomcrypt for sw decryption

The original download site for this software is : <http://manpages.ubuntu.com/manpages/saucy/man3/libtomcrypt.3.html> This piece of software is made available under the terms and conditions of the DO WHAT THE FUCK YOU WANT TO PUBLIC LICENSE

AsyncHttpClient (1.4.6)

The original download site for this software is : <http://loopj.com/android-async-http/> This piece of software is made available under the terms and conditions of the APACHE LICENSE 2.0

Jackson Parser (2.x)

lpepg client uses Jackson Parser for string manipulation. The original download site for this software is : <https://github.com/FasterXML/jackson-core> This piece of software is made available under the terms and conditions of the APACHE LICENSE 2.0

TP Vision Netherlands B.V. is grateful to the groups and individuals above for their contributions.

GNU GENERAL PUBLIC LICENSE

Version 2, June 1991

Copyright (C) 1989, 1991 Free Software Foundation, Inc.

51 Franklin Street, Fifth Floor, Boston, MA 02110-1301, USA

Everyone is permitted to copy and distribute verbatim copies

of this license document, but changing it is not allowed.

Preamble

The licenses for most software are designed to take away your freedom to share and change it. By contrast, the GNU General Public License is intended

to guarantee your freedom to share and change free software--to make sure the software is free for all its users. This General Public License applies to most of the Free Software Foundation's software and to any other program whose authors commit to using it. (Some other Free Software Foundation software is covered by the GNU Lesser General Public License instead.) You can apply it to your programs, too.

When we speak of free software, we are referring to freedom, not price. Our General Public Licenses are designed to make sure that you have the freedom to distribute copies of free software (and charge for this service if you wish), that you receive source code or can get it if you want it, that you can change the software or use pieces of it in new free programs; and that you know you can do these things.

To protect your rights, we need to make restrictions that forbid anyone to deny you these rights or to ask you to surrender the rights. These restrictions translate to certain responsibilities for you if you distribute copies of the software, or if you modify it.

For example, if you distribute copies of such a program, whether gratis or for a fee, you must give the recipients all the rights that you have. You must make sure that they, too, receive or can get the source code. And you must show them these terms so they know their rights.

We protect your rights with two steps: (1) copyright the software, and (2) offer you this license which gives you legal permission to copy, distribute and/or modify the software.

Also, for each author's protection and ours, we want to make certain that everyone understands that there is no warranty for this free software. If the software is modified by someone else and passed on, we want its recipients to know that what they have is not the original, so that any problems introduced by others will not reflect on the original authors' reputations.

Finally, any free program is threatened constantly by software patents. We wish to avoid the danger that redistributors of a free program will individually obtain patent licenses, in effect making the program proprietary. To prevent this, we have made it clear that any patent must be licensed for everyone's free use or not licensed at all.

The precise terms and conditions for copying, distribution and modification follow.

TERMS AND CONDITIONS FOR COPYING, DISTRIBUTION AND MODIFICATION

Activities other than copying, distribution and modification are not covered by this License; they are outside its scope. The act of running the Program is not restricted, and the output from the Program is covered only if its contents constitute a work based on the Program (independent of having been made by running the Program). Whether that is true

depends on what the Program does.

You may charge a fee for the physical act of transferring a copy, and you may at your option offer warranty protection in exchange for a fee.

a) You must cause the modified files to carry prominent notices stating that you changed the files and the date of any change.

b) You must cause any work that you distribute or publish, that in whole or in part contains or is derived from the Program or any part thereof, to be licensed as a whole at no charge to all third parties under the terms of this License.

c) If the modified program normally reads commands interactively when run, you must cause it, when started running for such interactive use in the most ordinary way, to print or display an announcement including an appropriate copyright notice and a notice that there is no warranty (or else, saying that you provide a warranty) and that users may redistribute the program under these conditions, and telling the user how to view a copy of this License. (Exception: if the Program itself is interactive but does not normally print such an announcement, your work based on the Program is not required to print an announcement.)

These requirements apply to the modified work as a whole. If identifiable sections of that work are not derived from the Program, and can be reasonably considered independent and separate works in themselves, then this License, and its terms, do not apply to those sections when you distribute them as separate works. But when you distribute the same sections as part of a whole which is a work based on the Program, the distribution of the whole must be on the terms of this License, whose permissions for other licensees extend to the entire whole, and thus to each and every part regardless of who wrote it.

Thus, it is not the intent of this section to claim rights or contest your rights to work written entirely by you; rather, the intent is to exercise the right to control the distribution of derivative or collective works based on the Program.

In addition, mere aggregation of another work not based on the Program with the Program (or with a work based on the Program) on a volume of a storage or distribution medium does not bring the other work under the scope of this License.

a) Accompany it with the complete corresponding machine-readable source code, which must be distributed under the terms of Sections 1 and 2 above on a medium customarily used for software interchange; or,

b) Accompany it with a written offer, valid for at least three years, to give any third party, for a charge no more than your cost of physically performing source distribution, a complete machine-readable copy of

the corresponding source code, to be distributed under the terms of Sections 1 and 2 above on a medium customarily used for software interchange; or,

c) Accompany it with the information you received as to the offer to distribute corresponding source code. (This alternative is allowed only for noncommercial distribution and only if you received the program in object code or executable form with such an offer, in accord with Subsection b above.)

The source code for a work means the preferred form of the work for making modifications to it. For an executable work, complete source code means all the source code for all modules it contains, plus any associated interface definition files, plus the scripts used to control compilation and installation of the executable. However, as a special exception, the source code distributed need not include anything that is normally distributed (in either source or binary form) with the major components (compiler, kernel, and so on) of the operating system on which the executable runs, unless that component itself accompanies the executable.

If distribution of executable or object code is made by offering access to copy from a designated place, then offering equivalent access to copy the source code from the same place counts as distribution of the source code, even though third parties are not compelled to copy the source along with the object code.

If any portion of this section is held invalid or unenforceable under any particular circumstance, the balance of the section is intended to apply and the section as a whole is intended to apply in other circumstances.

It is not the purpose of this section to induce you to infringe any patents or other property right claims or to contest validity of any such claims; this section has the sole purpose of protecting the integrity of the free software distribution system, which is implemented by public license practices. Many people have made generous contributions to the wide range of software distributed through that system in reliance on consistent application of that system; it is up to the author/donor to decide if he or she is willing to distribute software through any other system and a licensee cannot impose that choice.

This section is intended to make thoroughly clear what is believed to be a consequence of the rest of this License.

Each version is given a distinguishing version number. If the Program specifies a version number of this License which applies to it and "any later version", you have the option of following the terms and conditions either of that version or of any later version published by the Free Software Foundation. If the Program does not specify a version number of this

License, you may choose any version ever published by the Free Software Foundation.

NO WARRANTY

GNU LESSER GENERAL PUBLIC LICENSE

Version 2.1, February 1999

Copyright (C) 1991, 1999 Free Software Foundation, Inc.

51 Franklin Street, Fifth Floor, Boston, MA 02110-1301 USA

Everyone is permitted to copy and distribute verbatim copies

of this license document, but changing it is not allowed.

[This is the first released version of the Lesser GPL. It also counts as the successor of the GNU Library Public License, version 2, hence the version number 2.1.]

Preamble

The licenses for most software are designed to take away your freedom to share and change it. By contrast, the GNU General Public Licenses are intended to guarantee your freedom to share and change free software--to make sure the software is free for all its users.

This license, the Lesser General Public License, applies to some specially designated software packages--typically libraries--of the Free Software Foundation and other authors who decide to use it. You can use it too, but we suggest you first think carefully about whether this license or the ordinary General Public License is the better strategy to use in any particular case, based on the explanations below.

When we speak of free software, we are referring to freedom of use, not price. Our General Public Licenses are designed to make sure that you have the freedom to distribute copies of free software (and charge for this service if you wish); that you receive source code or can get it if you want it; that you can change the software and use pieces of it in new free programs; and that you are informed that you can do these things.

To protect your rights, we need to make restrictions that forbid distributors to deny you these rights or to ask you to surrender these rights. These restrictions translate to certain responsibilities for you if you distribute copies of the library or if you modify it.

For example, if you distribute copies of the library, whether gratis or for a fee, you must give the

recipients all the rights that we gave you. You must make sure that they, too, receive or can get the source code. If you link other code with the library, you must provide complete object files to the recipients, so that they can relink them with the library after making changes to the library and recompiling it. And you must show them these terms so they know their rights.

We protect your rights with a two-step method: (1) we copyright the library, and (2) we offer you this license, which gives you legal permission to copy, distribute and/or modify the library.

To protect each distributor, we want to make it very clear that there is no warranty for the free library. Also, if the library is modified by someone else and passed on, the recipients should know that what they have is not the original version, so that the original author's reputation will not be affected by problems that might be introduced by others.

Finally, software patents pose a constant threat to the existence of any free program. We wish to make sure that a company cannot effectively restrict the users of a free program by obtaining a restrictive license from a patent holder. Therefore, we insist that any patent license obtained for a version of the library must be consistent with the full freedom of use specified in this license.

Most GNU software, including some libraries, is covered by the ordinary GNU General Public License. This license, the GNU Lesser General Public License, applies to certain designated libraries, and is quite different from the ordinary General Public License. We use this license for certain libraries in order to permit linking those libraries into non-free programs.

When a program is linked with a library, whether statically or using a shared library, the combination of the two is legally speaking a combined work, a derivative of the original library. The ordinary General Public License therefore permits such linking only if the entire combination fits its criteria of freedom. The Lesser General Public License permits more lax criteria for linking other code with the library.

We call this license the "Lesser" General Public License because it does Less to protect the user's freedom than the ordinary General Public License. It also provides other free software developers Less of an advantage over competing non-free programs. These disadvantages are the reason we use the ordinary General Public License for many libraries. However, the Lesser license provides advantages in certain special circumstances.

For example, on rare occasions, there may be a special need to encourage the widest possible use of a certain library, so that it becomes a de-facto standard. To achieve this, non-free programs must be allowed to use the library. A more frequent case is that a free library does the same job as widely used

non-free libraries. In this case, there is little to gain by limiting the free library to free software only, so we use the Lesser General Public License.

In other cases, permission to use a particular library in non-free programs enables a greater number of people to use a large body of free software. For example, permission to use the GNU C Library in non-free programs enables many more people to use the whole GNU operating system, as well as its variant, the GNU/Linux operating system.

Although the Lesser General Public License is Less protective of the users' freedom, it does ensure that the user of a program that is linked with the Library has the freedom and the wherewithal to run that program using a modified version of the Library.

The precise terms and conditions for copying, distribution and modification follow. Pay close attention to the difference between a "work based on the library" and a "work that uses the library". The former contains code derived from the library, whereas the latter must be combined with the library in order to run.

TERMS AND CONDITIONS FOR COPYING, DISTRIBUTION AND MODIFICATION

A "library" means a collection of software functions and/or data prepared so as to be conveniently linked with application programs (which use some of those functions and data) to form executables.

The "Library", below, refers to any such software library or work which has been distributed under these terms. A "work based on the Library" means either the Library or any derivative work under copyright law: that is to say, a work containing the Library or a portion of it, either verbatim or with modifications and/or translated straightforwardly into another language. (Hereinafter, translation is included without limitation in the term "modification".)

"Source code" for a work means the preferred form of the work for making modifications to it. For a library, complete source code means all the source code for all modules it contains, plus any associated interface definition files, plus the scripts used to control compilation and installation of the library.

Activities other than copying, distribution and modification are not covered by this License; they are outside its scope. The act of running a program using the Library is not restricted, and output from such a program is covered only if its contents constitute a work based on the Library (independent of the use of the Library in a tool for writing it). Whether that is true depends on what the Library does and what the program that uses the Library does.

You may charge a fee for the physical act of transferring a copy, and you may at your option offer warranty protection in exchange for a fee.

?a) The modified work must itself be a software library.

?b) You must cause the files modified to carry prominent notices stating that you changed the files and the date of any change.

?c) You must cause the whole of the work to be licensed at no charge to all third parties under the terms of this License.

?d) If a facility in the modified Library refers to a function or a table of data to be supplied by an application program that uses the facility, other than as an argument passed when the facility is invoked, then you must make a good faith effort to ensure that, in the event an application does not supply such function or table, the facility still operates, and performs whatever part of its purpose remains meaningful.

(For example, a function in a library to compute square roots has a purpose that is entirely well-defined independent of the application. Therefore, Subsection 2d requires that any application-supplied function or table used by this function must be optional: if the application does not supply it, the square root function must still compute square roots.)

These requirements apply to the modified work as a whole. If identifiable sections of that work are not derived from the Library, and can be reasonably considered independent and separate works in themselves, then this License, and its terms, do not apply to those sections when you distribute them as separate works. But when you distribute the same sections as part of a whole which is a work based on the Library, the distribution of the whole must be on the terms of this License, whose permissions for other licensees extend to the entire whole, and thus to each and every part regardless of who wrote it.

Thus, it is not the intent of this section to claim rights or contest your rights to work written entirely by you; rather, the intent is to exercise the right to control the distribution of derivative or collective works based on the Library.

In addition, mere aggregation of another work not based on the Library with the Library (or with a work based on the Library) on a volume of a storage or distribution medium does not bring the other work under the scope of this License.

Once this change is made in a given copy, it is irreversible for that copy, so the ordinary GNU General Public License applies to all subsequent copies and derivative works made from that copy.

This option is useful when you wish to copy part of the code of the Library into a program that is not a library.

If distribution of object code is made by offering access to copy from a designated place, then offering

equivalent access to copy the source code from the same place satisfies the requirement to distribute the source code, even though third parties are not compelled to copy the source along with the object code.

However, linking a "work that uses the Library" with the Library creates an executable that is a derivative of the Library (because it contains portions of the Library), rather than a "work that uses the library". The executable is therefore covered by this License. Section 6 states terms for distribution of such executables.

When a "work that uses the Library" uses material from a header file that is part of the Library, the object code for the work may be a derivative work of the Library even though the source code is not. Whether this is true is especially significant if the work can be linked without the Library, or if the work is itself a library. The threshold for this to be true is not precisely defined by law.

If such an object file uses only numerical parameters, data structure layouts and accessors, and small macros and small inline functions (ten lines or less in length), then the use of the object file is unrestricted, regardless of whether it is legally a derivative work. (Executables containing this object code plus portions of the Library will still fall under Section 6.)

Otherwise, if the work is a derivative of the Library, you may distribute the object code for the work under the terms of Section 6. Any executables containing that work also fall under Section 6, whether or not they are linked directly with the Library itself.

You must give prominent notice with each copy of the work that the Library is used in it and that the Library and its use are covered by this License. You must supply a copy of this License. If the work during execution displays copyright notices, you must include the copyright notice for the Library among them, as well as a reference directing the user to the copy of this License. Also, you must do one of these things:

?a) Accompany the work with the complete corresponding machine-readable source code for the Library including whatever changes were used in the work (which must be distributed under Sections 1 and 2 above); and, if the work is an executable linked with the Library, with the complete machine-readable "work that uses the Library", as object code and/or source code, so that the user can modify the Library and then relink to produce a modified executable containing the modified Library. (It is understood that the user who changes the contents of definitions files in the Library will not necessarily be able to recompile the application to use the modified definitions.)

?b) Use a suitable shared library mechanism for linking with the Library. A suitable mechanism is one that (1) uses at run time a copy of the library already

present on the user's computer system, rather than copying library functions into the executable, and (2) will operate properly with a modified version of the library, if the user installs one, as long as the modified version is interface-compatible with the version that the work was made with.

?c) Accompany the work with a written offer, valid for at least three years, to give the same user the materials specified in Subsection 6a, above, for a charge no more than the cost of performing this distribution.

?d) If distribution of the work is made by offering access to copy from a designated place, offer equivalent access to copy the above specified materials from the same place.

?e) Verify that the user has already received a copy of these materials or that you have already sent this user a copy.

For an executable, the required form of the "work that uses the Library" must include any data and utility programs needed for reproducing the executable from it. However, as a special exception, the materials to be distributed need not include anything that is normally distributed (in either source or binary form) with the major components (compiler, kernel, and so on) of the operating system on which the executable runs, unless that component itself accompanies the executable.

It may happen that this requirement contradicts the license restrictions of other proprietary libraries that do not normally accompany the operating system. Such a contradiction means you cannot use both them and the Library together in an executable that you distribute.

?a) Accompany the combined library with a copy of the same work based on the Library, uncombined with any other library facilities. This must be distributed under the terms of the Sections above.

?b) Give prominent notice with the combined library of the fact that part of it is a work based on the Library, and explaining where to find the accompanying uncombined form of the same work.

If any portion of this section is held invalid or unenforceable under any particular circumstance, the balance of the section is intended to apply, and the section as a whole is intended to apply in other circumstances.

It is not the purpose of this section to induce you to infringe any patents or other property right claims or to contest validity of any such claims; this section has the sole purpose of protecting the integrity of the free software distribution system which is implemented by public license practices. Many people have made generous contributions to the wide range of software distributed through that system in reliance on consistent application of that system; it is up to the

author/donor to decide if he or she is willing to distribute software through any other system and a licensee cannot impose that choice.

This section is intended to make thoroughly clear what is believed to be a consequence of the rest of this License.

Each version is given a distinguishing version number. If the Library specifies a version number of this License which applies to it and "any later version", you have the option of following the terms and conditions either of that version or of any later version published by the Free Software Foundation. If the Library does not specify a license version number, you may choose any version ever published by the Free Software Foundation.

NO WARRANTY

BSD LICENSE

Redistribution and use in source and binary forms, with or without modification, are permitted provided that the following conditions are met:

THIS SOFTWARE IS PROVIDED BY THE REGENTS AND CONTRIBUTORS "AS IS" AND ANY EXPRESS OR IMPLIED WARRANTIES, INCLUDING, BUT NOT LIMITED TO, THE IMPLIED WARRANTIES OF MERCHANTABILITY AND FITNESS FOR A PARTICULAR PURPOSE ARE DISCLAIMED. IN NO EVENT SHALL THE REGENTS OR CONTRIBUTORS BE LIABLE FOR ANY DIRECT, INDIRECT, INCIDENTAL, SPECIAL, EXEMPLARY, OR CONSEQUENTIAL DAMAGES (INCLUDING, BUT NOT LIMITED TO, PROCUREMENT OF SUBSTITUTE GOODS OR SERVICES; LOSS OF USE, DATA, OR PROFITS; OR BUSINESS INTERRUPTION) HOWEVER CAUSED AND ON ANY THEORY OF LIABILITY, WHETHER IN CONTRACT, STRICT LIABILITY, OR TORT (INCLUDING NEGLIGENCE OR OTHERWISE) ARISING IN ANY WAY OUT OF THE USE OF THIS SOFTWARE, EVEN IF ADVISED OF THE POSSIBILITY OF SUCH DAMAGE.

MIT LICENSE

Permission is hereby granted, free of charge, to any person obtaining

a copy of this software and associated documentation files (the

"Software"), to deal in the Software without restriction, including

without limitation the rights to use, copy, modify, merge, publish, distribute, sublicense, and/or sell copies of the Software, and to permit persons to whom the Software is furnished to do so, subject to the following conditions:

The above copyright notice and this permission notice shall be included in all copies or substantial portions of the Software.

THE SOFTWARE IS PROVIDED "AS IS", WITHOUT WARRANTY OF ANY KIND, EXPRESS OR IMPLIED, INCLUDING BUT NOT LIMITED TO THE WARRANTIES OF MERCHANTABILITY, FITNESS FOR A PARTICULAR PURPOSE AND NONINFRINGEMENT. IN NO EVENT SHALL THE AUTHORS OR COPYRIGHT HOLDERS BE LIABLE FOR ANY CLAIM, DAMAGES OR OTHER LIABILITY, WHETHER IN AN ACTION OF CONTRACT, TORT OR OTHERWISE, ARISING FROM, OUT OF OR IN CONNECTION WITH THE SOFTWARE OR THE USE OR OTHER DEALINGS IN THE SOFTWARE.

Apache
License
Version 2.0,
January 2004
<http://www.apache.org/licenses/>

TERMS AND CONDITIONS FOR USE, REPRODUCTION, AND DISTRIBUTION

1. Definitions.

"License" shall mean the terms and conditions for use, reproduction, and distribution as defined by Sections 1 through 9 of this document.

"Licensor" shall mean the copyright owner or

entity authorized by the copyright owner that is granting the License.

"Legal Entity" shall mean the union of the acting entity and all

other entities that control, are controlled by, or are under common

control with that entity. For the purposes of this definition,

"control" means (i) the power, direct or indirect, to cause the

direction or management of such entity, whether by contract or

otherwise, or (ii) ownership of fifty percent (50%) or more of the

outstanding shares, or (iii) beneficial ownership of such entity.

"You" (or "Your") shall mean an individual or Legal Entity

exercising permissions granted by this License.

"Source" form shall mean the preferred form for making modifications,

including but not limited to software source code, documentation

source, and configuration files.

"Object" form shall mean any form resulting from mechanical

transformation or translation of a Source form, including but

not limited to compiled object code, generated documentation,

and conversions to other media types.

"Work" shall mean the work of authorship, whether in Source or

Object form, made available under the License, as indicated by a

copyright notice that is included in or attached to the work

(an example is provided in the Appendix below).

"Derivative Works" shall mean any work, whether in Source or Object

form, that is based on (or derived from) the Work and for which the

editorial revisions, annotations, elaborations, or other modifications

represent, as a whole, an original work of authorship. For the purposes

of this License, Derivative Works shall not include works that remain

separable from, or merely link (or bind by name) to the interfaces of,

the Work and Derivative Works thereof.

"Contribution" shall mean any work of authorship, including

the original version of the Work and any modifications or additions

to that Work or Derivative Works thereof, that is intentionally

submitted to Licensor for inclusion in the Work by the copyright owner

or by an individual or Legal Entity authorized to submit on behalf of

the copyright owner. For the purposes of this definition, "submitted"

means any form of electronic, verbal, or written communication sent

to the Licensor or its representatives, including but not limited to

communication on electronic mailing lists, source code control systems,

and issue tracking systems that are managed by, or on behalf of, the

Licensor for the purpose of discussing and improving the Work, but

excluding communication that is conspicuously marked or otherwise

designated in writing by the copyright owner as "Not a Contribution."

"Contributor" shall mean Licensor and any individual or Legal Entity

on behalf of whom a Contribution has been received by Licensor and

subsequently incorporated within the Work.

2. Grant of Copyright License. Subject to the terms and conditions of

this License, each Contributor hereby grants to

You a perpetual,

worldwide, non-exclusive, no-charge, royalty-free, irrevocable

copyright license to reproduce, prepare Derivative Works of,

publicly display, publicly perform, sublicense, and distribute the

Work and such Derivative Works in Source or Object form.

3. Grant of Patent License. Subject to the terms and conditions of

this License, each Contributor hereby grants to You a perpetual,

worldwide, non-exclusive, no-charge, royalty-free, irrevocable

(except as stated in this section) patent license to make, have made,

use, offer to sell, sell, import, and otherwise transfer the Work,

where such license applies only to those patent claims licensable

by such Contributor that are necessarily infringed by their

Contribution(s) alone or by combination of their Contribution(s)

with the Work to which such Contribution(s) was submitted. If You

institute patent litigation against any entity (including a

cross-claim or counterclaim in a lawsuit) alleging that the Work

or a Contribution incorporated within the Work constitutes direct

or contributory patent infringement, then any patent licenses

granted to You under this License for that Work shall terminate

as of the date such litigation is filed.

4. Redistribution. You may reproduce and distribute copies of the

Work or Derivative Works thereof in any medium, with or without

modifications, and in Source or Object form, provided that You

meet the following conditions:

(a) You must give any other recipients of the Work or

Derivative Works a copy of this License; and

(b) You must cause any modified files to carry prominent notices

stating that You changed the files; and

(c) You must retain, in the Source form of any Derivative Works

that You distribute, all copyright, patent, trademark, and

attribution notices from the Source form of the Work,

excluding those notices that do not pertain to any part of

the Derivative Works; and

(d) If the Work includes a "NOTICE" text file as part of its

distribution, then any Derivative Works that You distribute must

include a readable copy of the attribution notices contained

within such NOTICE file, excluding those notices that do not

pertain to any part of the Derivative Works, in at least one

of the following places: within a NOTICE text file distributed

as part of the Derivative Works; within the Source form or

documentation, if provided along with the Derivative Works; or,

within a display generated by the Derivative Works, if and

wherever such third-party notices normally appear. The contents

of the NOTICE file are for informational purposes only and

do not modify the License. You may add Your own attribution

notices within Derivative Works that You distribute, alongside

or as an addendum to the NOTICE text from the Work, provided

that such additional attribution notices

cannot be construed

as modifying the License.

You may add Your own copyright statement to Your modifications and

may provide additional or different license terms and conditions

for use, reproduction, or distribution of Your modifications, or

for any such Derivative Works as a whole, provided Your use,

reproduction, and distribution of the Work otherwise complies with

the conditions stated in this License.

5. Submission of Contributions. Unless You explicitly state otherwise,

any Contribution intentionally submitted for inclusion in the Work

by You to the Licensor shall be under the terms and conditions of

this License, without any additional terms or conditions.

Notwithstanding the above, nothing herein shall supersede or modify

the terms of any separate license agreement you may have executed

with Licensor regarding such Contributions.

6. Trademarks. This License does not grant permission to use the trade

names, trademarks, service marks, or product names of the Licensor,

except as required for reasonable and customary use in describing the

origin of the Work and reproducing the content of the NOTICE file.

7. Disclaimer of Warranty. Unless required by applicable law or

agreed to in writing, Licensor provides the Work (and each

Contributor provides its Contributions) on an "AS IS" BASIS,

WITHOUT WARRANTIES OR CONDITIONS OF ANY KIND, either express or

implied, including, without limitation, any warranties or conditions

of TITLE, NON-INFRINGEMENT, MERCHANTABILITY, or FITNESS FOR A

PARTICULAR PURPOSE. You are solely responsible for determining the

appropriateness of using or redistributing the Work and assume any

risks associated with Your exercise of permissions under this License.

8. Limitation of Liability. In no event and under no legal theory,

whether in tort (including negligence), contract, or otherwise,

unless required by applicable law (such as deliberate and grossly

negligent acts) or agreed to in writing, shall any Contributor be

liable to You for damages, including any direct, indirect, special,

incidental, or consequential damages of any character arising as a

result of this License or out of the use or inability to use the

Work (including but not limited to damages for loss of goodwill,

work stoppage, computer failure or malfunction, or any and all

other commercial damages or losses), even if such Contributor

has been advised of the possibility of such damages.

9. Accepting Warranty or Additional Liability. While redistributing

the Work or Derivative Works thereof, You may choose to offer,

and charge a fee for, acceptance of support, warranty, indemnity,

or other liability obligations and/or rights consistent with this

License. However, in accepting such obligations, You may act only

on Your own behalf and on Your sole responsibility, not on behalf

of any other Contributor, and only if You agree to indemnify,

defend, and hold each Contributor harmless for any liability

incurred by, or claims asserted against, such Contributor by reason

of your accepting any such warranty or additional liability.

END OF TERMS AND CONDITIONS

APPENDIX: How to apply the Apache License to your work.

To apply the Apache License to your work, attach the following

boilerplate notice, with the fields enclosed by brackets "[]"

replaced with your own identifying information. (Don't include

the brackets!) The text should be enclosed in the appropriate

comment syntax for the file format. We also recommend that a

file or class name and description of purpose be included on the

same "printed page" as the copyright notice for easier

identification within third-party archives.

Copyright [yyyy] [name of copyright owner]

Licensed under the Apache License, Version 2.0 (the "License");

you may not use this file except in compliance with the License.

You may obtain a copy of the License at

<http://www.apache.org/licenses/LICENSE-2.0>

Unless required by applicable law or agreed to in writing, software

distributed under the License is distributed on an "AS IS" BASIS,

WITHOUT WARRANTIES OR CONDITIONS OF ANY KIND, either express or implied.

See the License for the specific language governing permissions and

limitations under the License.

This copy of the libpng notices is provided for your convenience. In case of any discrepancy between this copy and the notices in the file png.h that is included in the libpng distribution, the latter shall prevail.

COPYRIGHT NOTICE, DISCLAIMER, and LICENSE:

If you modify libpng you may insert additional notices immediately following this sentence.

This code is released under the libpng license.

libpng versions 1.2.6, August 15, 2004, through 1.4.1, February 25, 2010, are

Copyright (c) 2004, 2006-2007 Glenn Randers-Pehrson, and are

distributed according to the same disclaimer and license as libpng-1.2.5

with the following individual added to the list of Contributing Authors

Cosmin Truta

libpng versions 1.0.7, July 1, 2000, through 1.2.5 - October 3, 2002, are

Copyright (c) 2000-2002 Glenn Randers-Pehrson, and are

distributed according to the same disclaimer and license as libpng-1.0.6

with the following individuals added to the list of Contributing Authors

Simon-Pierre Cadieux

Eric S. Raymond

Gilles Vollant

and with the following additions to the disclaimer:

There is no warranty against interference with your enjoyment of the

library or against infringement. There is no warranty that our

efforts or the library will fulfill any of your particular purposes

or needs. This library is provided with all faults, and the entire

risk of satisfactory quality, performance, accuracy, and effort is with

the user.

libpng versions 0.97, January 1998, through 1.0.6, March 20, 2000, are

Copyright (c) 1998, 1999 Glenn Randers-Pehrson, and are

distributed according to the same disclaimer and license as libpng-0.96,

with the following individuals added to the list of Contributing Authors:

Tom Lane

Glenn Randers-Pehrson

Willem van Schaik

libpng versions 0.89, June 1996, through 0.96, May 1997, are

Copyright (c) 1996, 1997 Andreas Dilger

Distributed according to the same disclaimer and license as libpng-0.88,

with the following individuals added to the list of Contributing Authors:

John Bowler

Kevin Bracey

Sam Bushell

Magnus Holmgren

Greg Roelofs

Tom Tanner

libpng versions 0.5, May 1995, through 0.88, January 1996, are

Copyright (c) 1995, 1996 Guy Eric Schalnat, Group 42, Inc.

For the purposes of this copyright and license,

"Contributing Authors"

is defined as the following set of individuals:

Andreas Dilger

Dave Martindale

Guy Eric Schalnat

Paul Schmidt

Tim Wegner

The PNG Reference Library is supplied "AS IS". The Contributing Authors

and Group 42, Inc. disclaim all warranties, expressed or implied,

including, without limitation, the warranties of merchantability and of

fitness for any purpose. The Contributing Authors and Group 42, Inc.

assume no liability for direct, indirect, incidental, special, exemplary,

or consequential damages, which may result from the use of the PNG

Reference Library, even if advised of the possibility of such damage.

Permission is hereby granted to use, copy, modify, and distribute this

source code, or portions hereof, for any purpose, without fee, subject

to the following restrictions:

be misrepresented as being the original source.

source or altered source distribution.

The Contributing Authors and Group 42, Inc. specifically permit, without

fee, and encourage the use of this source code as a component to

supporting the PNG file format in commercial products. If you use this

source code in a product, acknowledgment is not required but would be

A "png_get_copyright" function is available, for convenient use in "about"

boxes and the like:

```
printf("%s",png_get_copyright(NULL));
```

Also, the PNG logo (in PNG format, of course) is supplied in the

files "pngbar.png.jpg" and "pngbar.jpg (88x31) and "pngnow.png.jpg" (98x31).

Libpng is OSI Certified Open Source Software. OSI Certified Open Source is a

certification mark of the Open Source Initiative.

Glenn Randers-Pehrson

glennrp at users.sourceforge.net

February 25, 2010

This software is based in part on the work of the FreeType Team.

The FreeType Project
LICENSE

2006-Jan-27

Copyright 1996-2002,
2006 by
David Turner, Robert Wilhelm, and
Werner Lemberg

Introduction
=====

The FreeType Project is distributed in several

archive packages;

some of them may contain, in addition to the FreeType font engine,

various tools and contributions which rely on, or relate to, the

FreeType Project.

This license applies to all files found in such packages, and

which do not fall under their own explicit license. The license

affects thus the FreeType font engine, the test programs,

documentation and makefiles, at the very least.

This license was inspired by the BSD, Artistic, and IJG

(Independent JPEG Group) licenses, which all encourage inclusion

and use of free software in commercial and freeware products

alike. As a consequence, its main points are that:

o We don't promise that this software works. However, we will be

interested in any kind of bug reports. ('as is' distribution)

o You can use this software for whatever you want, in parts or

full form, without having to pay us. ('royalty-free' usage)

o You may not pretend that you wrote this software. If you use

it, or only parts of it, in a program, you must acknowledge

somewhere in your documentation that you have used the

FreeType code. ('credits')

We specifically permit and encourage the inclusion of this

software, with or without modifications, in commercial products.

We disclaim all warranties covering The FreeType Project and

assume no liability related to The FreeType Project.

Finally, many people asked us for a preferred form for a

credit/disclaimer to use in compliance with this license. We thus

encourage you to use the following text:

""

Portions of this software are copyright ?<year> The FreeType

Project (www.freetype.org). All rights reserved.

""

Please replace <year> with the value from the FreeType version you

actually use.

Legal Terms

=====

Throughout this license, the terms 'package', 'FreeType Project',

and 'FreeType archive' refer to the set of files originally

distributed by the authors (David Turner, Robert Wilhelm, and

Werner Lemberg) as the 'FreeType Project', be they named as alpha,

beta or final release.

'You' refers to the licensee, or person using the project, where

'using' is a generic term including compiling the project's source

code as well as linking it to form a 'program' or 'executable'.

This program is referred to as 'a program using the FreeType

engine'.

This license applies to all files distributed in the original

FreeType Project, including all source code, binaries and

documentation, unless otherwise stated in the file in its

original, unmodified form as distributed in the original archive.

If you are unsure whether or not a particular file is covered by

this license, you must contact us to verify this.

The FreeType Project is copyright (C) 1996-2000 by David Turner,

Robert Wilhelm, and Werner Lemberg. All rights reserved except as

specified below.

THE FREETYPE PROJECT IS PROVIDED 'AS IS' WITHOUT WARRANTY OF ANY

KIND, EITHER EXPRESS OR IMPLIED, INCLUDING, BUT NOT LIMITED TO,

WARRANTIES OF MERCHANTABILITY AND FITNESS FOR A PARTICULAR

PURPOSE. IN NO EVENT WILL ANY OF THE AUTHORS OR COPYRIGHT HOLDERS

BE LIABLE FOR ANY DAMAGES CAUSED BY THE USE OR THE INABILITY TO

USE, OF THE FREETYPE PROJECT.

This license grants a worldwide, royalty-free, perpetual and

irrevocable right and license to use, execute, perform, compile,

display, copy, create derivative works of, distribute and

sublicense the FreeType Project (in both source and object code

forms) and derivative works thereof for any purpose; and to

authorize others to exercise some or all of the rights granted

herein, subject to the following conditions:

o Redistribution of source code must retain this license file

('FTL.TXT') unaltered; any additions, deletions or changes to

the original files must be clearly indicated in accompanying

documentation. The copyright notices of the unaltered,

original files must be preserved in all copies of source

files.

o Redistribution in binary form must provide a disclaimer that

states that the software is based in part of the work of the

FreeType Team, in the distribution documentation. We also

encourage you to put an URL to the FreeType web page in your

documentation, though this isn't mandatory.

These conditions apply to any software derived from or based on

the FreeType Project, not just the unmodified files. If you use

our work, you must acknowledge us. However, no fee need be paid

to us.

Neither the FreeType authors and contributors nor you shall use

the name of the other for commercial, advertising, or promotional

purposes without specific prior written permission.

We suggest, but do not require, that you use one or more of the

following phrases to refer to this software in your documentation

or advertising materials: 'FreeType Project', 'FreeType Engine',

'FreeType library', or 'FreeType Distribution'.

As you have not signed this license, you are not required to

accept it. However, as the FreeType Project is copyrighted

material, only this license, or another one contracted with the

authors, grants you the right to use, distribute, and modify it.

Therefore, by using, distributing, or modifying the FreeType

Project, you indicate that you understand and accept all the terms

of this license.

There are two mailing lists related to FreeType:

o freetype@nongnu.org

Discusses general use and applications of FreeType, as well as

future and wanted additions to the library and distribution.

If you are looking for support, start in this list if you

haven't found anything to help you in the documentation.

o freetype-devel@nongnu.org

Discusses bugs, as well as engine internals, design issues,

specific licenses, porting, etc.

Our home page can be found at

<http://www.freetype.org>

--- end of FTL.TXT ---

LICENSE ISSUES

=====

The OpenSSL toolkit stays under a dual license, i.e. both the conditions of

the OpenSSL License and the original SSLeay license apply to the toolkit.

See below for the actual license texts. Actually both licenses are BSD-style

Open Source licenses. In case of any license issues related to OpenSSL

please contact openssl-core@openssl.org.

OpenSSL License

/*

=====

* Copyright (c) 1998-2011 The OpenSSL Project. All rights reserved.

*

* Redistribution and use in source and binary forms, with or without

* modification, are permitted provided that the following conditions

* are met:

*

* 1. Redistributions of source code must retain the above copyright

* notice, this list of conditions and the following disclaimer.

*

* 2. Redistributions in binary form must reproduce the above copyright

* notice, this list of conditions and the following disclaimer in

* the documentation and/or other materials provided with the

* distribution.

*

* 3. All advertising materials mentioning features or use of this

* software must display the following acknowledgment:

* "This product includes software developed by the OpenSSL Project

* for use in the OpenSSL Toolkit.
 (<http://www.openssl.org/>)"

*

* 4. The names "OpenSSL Toolkit" and "OpenSSL Project" must not be used to

* endorse or promote products derived from this software without

* prior written permission. For written permission, please contact

* openssl-core@openssl.org.

*

* 5. Products derived from this software may not be called "OpenSSL"

* nor may "OpenSSL" appear in their names without prior written

* permission of the OpenSSL Project.

*

* 6. Redistributions of any form whatsoever must retain the following

* acknowledgment:

* "This product includes software developed by the OpenSSL Project

* for use in the OpenSSL Toolkit
 (<http://www.openssl.org/>)"

*

* THIS SOFTWARE IS PROVIDED BY THE OpenSSL PROJECT "AS IS" AND ANY

* EXPRESSED OR IMPLIED WARRANTIES, INCLUDING, BUT NOT LIMITED TO, THE

* IMPLIED WARRANTIES OF MERCHANTABILITY AND FITNESS FOR A PARTICULAR

* PURPOSE ARE DISCLAIMED. IN NO EVENT SHALL THE OpenSSL PROJECT OR

* ITS CONTRIBUTORS BE LIABLE FOR ANY DIRECT, INDIRECT, INCIDENTAL,

* SPECIAL, EXEMPLARY, OR CONSEQUENTIAL DAMAGES (INCLUDING, BUT

* NOT LIMITED TO, PROCUREMENT OF SUBSTITUTE GOODS OR SERVICES;

* LOSS OF USE, DATA, OR PROFITS; OR BUSINESS INTERRUPTION)

* HOWEVER CAUSED AND ON ANY THEORY OF LIABILITY, WHETHER IN CONTRACT,

* STRICT LIABILITY, OR TORT (INCLUDING NEGLIGENCE OR OTHERWISE)

* ARISING IN ANY WAY OUT OF THE USE OF THIS SOFTWARE, EVEN IF ADVISED

* OF THE POSSIBILITY OF SUCH DAMAGE.

*

=====

*

* This product includes cryptographic software written by Eric Young

* (ey@cryptsoft.com). This product includes software written by Tim

* Hudson (tjh@cryptsoft.com).

*

*/

Original SSLeay License

/* Copyright (C) 1995-1998 Eric Young
 (ey@cryptsoft.com)

* All rights reserved.

*

* This package is an SSL implementation written

* by Eric Young (ey@cryptsoft.com).

* The implementation was written so as to conform with Netscapes SSL.

*

* This library is free for commercial and non-commercial use as long as

* the following conditions are aheared to. The following conditions

* apply to all code found in this distribution, be it the RC4, RSA,

* lhash, DES, etc., code; not just the SSL code. The SSL documentation

* included with this distribution is covered by the same copyright terms

* except that the holder is Tim Hudson (tjh@cryptsoft.com).

*

* Copyright remains Eric Young's, and as such any Copyright notices in

* the code are not to be removed.

* If this package is used in a product, Eric Young should be given attribution

* as the author of the parts of the library used.

* This can be in the form of a textual message at program startup or

* in documentation (online or textual) provided with the package.

- * Redistribution and use in source and binary forms, with or without
- * modification, are permitted provided that the following conditions
- * are met:
- * 1. Redistributions of source code must retain the copyright
 - * notice, this list of conditions and the following disclaimer.
- * 2. Redistributions in binary form must reproduce the above copyright
 - * notice, this list of conditions and the following disclaimer in the
 - * documentation and/or other materials provided with the distribution.
- * 3. All advertising materials mentioning features or use of this software
 - * must display the following acknowledgement:
 - * "This product includes cryptographic software written by
 - * Eric Young (eay@cryptsoft.com)"
 - * The word 'cryptographic' can be left out if the rouines from the library
 - * being used are not cryptographic related :-).
- * 4. If you include any Windows specific code (or a derivative thereof) from
 - * the apps directory (application code) you must include an acknowledgement:
 - * "This product includes software written by Tim Hudson (tjh@cryptsoft.com)"
- * THIS SOFTWARE IS PROVIDED BY ERIC YOUNG ``AS IS'' AND
- * ANY EXPRESS OR IMPLIED WARRANTIES, INCLUDING, BUT NOT LIMITED TO, THE
- * IMPLIED WARRANTIES OF MERCHANTABILITY AND FITNESS FOR A PARTICULAR PURPOSE
- * ARE DISCLAIMED. IN NO EVENT SHALL THE AUTHOR OR CONTRIBUTORS BE LIABLE
- * FOR ANY DIRECT, INDIRECT, INCIDENTAL, SPECIAL, EXEMPLARY, OR CONSEQUENTIAL
- * DAMAGES (INCLUDING, BUT NOT LIMITED TO, PROCUREMENT OF SUBSTITUTE GOODS
- * OR SERVICES; LOSS OF USE, DATA, OR PROFITS; OR BUSINESS INTERRUPTION)
- * HOWEVER CAUSED AND ON ANY THEORY OF LIABILITY, WHETHER IN CONTRACT, STRICT

- * LIABILITY, OR TORT (INCLUDING NEGLIGENCE OR OTHERWISE) ARISING IN ANY WAY
- * OUT OF THE USE OF THIS SOFTWARE, EVEN IF ADVISED OF THE POSSIBILITY OF
- * SUCH DAMAGE.
- * The licence and distribution terms for any publically available version or
- * derivative of this code cannot be changed. i.e. this code cannot simply be
- * copied and put under another distribution licence
- * [including the GNU Public Licence.]
- */

 MOZILLA PUBLIC
 LICENSE
 Version 1.1

1.0.1. "Commercial Use" means distribution or otherwise making the Covered Code available to a third party.

1.1. "Contributor" means each entity that creates or contributes to the creation of Modifications.

1.2. "Contributor Version" means the combination of the Original Code, prior Modifications used by a Contributor, and the Modifications made by that particular Contributor.

1.3. "Covered Code" means the Original Code or Modifications or the combination of the Original Code and Modifications, in each case including portions thereof.

1.4. "Electronic Distribution Mechanism" means a mechanism generally

accepted in the software development community for the electronic

transfer of data.

1.5. "Executable" means Covered Code in any form other than Source

Code.

1.6. "Initial Developer" means the individual or entity identified

as the Initial Developer in the Source Code notice required by Exhibit

A.

1.7. "Larger Work" means a work which combines Covered Code or

portions thereof with code not governed by the terms of this License.

1.8. "License" means this document.

1.8.1. "Licensable" means having the right to grant, to the maximum

extent possible, whether at the time of the initial grant or

subsequently acquired, any and all of the rights conveyed herein.

1.9. "Modifications" means any addition to or deletion from the

substance or structure of either the Original Code or any previous

Modifications. When Covered Code is released as a series of files, a

Modification is:

A. Any addition to or deletion from the contents of a file

containing Original Code or previous Modifications.

B. Any new file that contains any part of the Original Code or

previous Modifications.

1.10. "Original Code" means Source Code of computer software code

which is described in the Source Code notice required by Exhibit A as

Original Code, and which, at the time of its release under this

License is not already Covered Code governed by this License.

1.10.1. "Patent Claims" means any patent claim(s), now owned or

hereafter acquired, including without limitation, method, process,

and apparatus claims, in any patent Licensable by grantor.

1.11. "Source Code" means the preferred form of the Covered Code for

making modifications to it, including all modules it contains, plus

any associated interface definition files, scripts used to control

compilation and installation of an Executable, or source code

differential comparisons against either the Original Code or another

well known, available Covered Code of the Contributor's choice. The

Source Code can be in a compressed or archival form, provided the

appropriate decompression or de-archiving software is widely available

for no charge.

1.12. "You" (or "Your") means an individual or a legal entity

exercising rights under, and complying with all of the terms of, this

License or a future version of this License issued under Section 6.1.

For legal entities, "You" includes any entity which controls, is

controlled by, or is under common control with You. For purposes of

this definition, "control" means (a) the power, direct or indirect,

to cause the direction or management of such entity, whether by

contract or otherwise, or (b) ownership of more than fifty percent

(50%) of the outstanding shares or beneficial ownership of such

entity.

2.1. The Initial Developer Grant.

The Initial Developer hereby grants You a world-wide, royalty-free,

non-exclusive license, subject to third party intellectual property

claims:

(a) under intellectual property rights (other than patent or

trademark) Licensable by Initial Developer to use, reproduce,

modify, display, perform, sublicense and distribute the Original

Code (or portions thereof) with or without Modifications, and/or

as part of a Larger Work; and

(b) under Patents Claims infringed by the making, using or

selling of Original Code, to make, have made, use, practice,

sell, and offer for sale, and/or otherwise dispose of the

Original Code (or portions thereof).

(c) the licenses granted in this Section 2.1(a) and (b) are

effective on the date Initial Developer first distributes

Original Code under the terms of this License.

(d) Notwithstanding Section 2.1(b) above, no patent license is

granted: 1) for code that You delete from the Original Code; 2)

separate from the Original Code; or 3) for infringements caused

by: i) the modification of the Original Code or ii) the

combination of the Original Code with

other software or devices.

2.2. Contributor Grant.

Subject to third party intellectual property claims, each Contributor

hereby grants You a world-wide, royalty-free, non-exclusive license

(a) under intellectual property rights (other than patent or

trademark) Licensable by Contributor, to use, reproduce, modify,

display, perform, sublicense and distribute the Modifications

created by such Contributor (or portions thereof) either on an

unmodified basis, with other Modifications, as Covered Code

and/or as part of a Larger Work; and

(b) under Patent Claims infringed by the making, using, or

selling of Modifications made by that Contributor either alone

and/or in combination with its Contributor Version (or portions

of such combination), to make, use, sell, offer for sale, have

made, and/or otherwise dispose of: 1) Modifications made by that

Contributor (or portions thereof); and 2) the combination of

Modifications made by that Contributor with its Contributor

Version (or portions of such combination).

(c) the licenses granted in Sections 2.2(a) and 2.2(b) are

effective on the date Contributor first makes Commercial Use of

the Covered Code.

(d) Notwithstanding Section 2.2(b) above, no patent license is

granted: 1) for any code that Contributor has deleted from the

Contributor Version; 2) separate from the Contributor Version;

3) for infringements caused by: i) third party modifications of

Contributor Version or ii) the combination of Modifications made

by that Contributor with other software (except as part of the

Contributor Version) or other devices; or 4) under Patent Claims

infringed by Covered Code in the absence of Modifications made by

that Contributor.

3.1. Application of License.

The Modifications which You create or to which You contribute are

governed by the terms of this License, including without limitation

Section 2.2. The Source Code version of Covered Code may be

distributed only under the terms of this License or a future version

of this License released under Section 6.1, and You must include a

copy of this License with every copy of the Source Code You

distribute. You may not offer or impose any terms on any Source Code

version that alters or restricts the applicable version of this

License or the recipients' rights hereunder. However, You may include

an additional document offering the additional rights described in

Section 3.5.

3.2. Availability of Source Code.

Any Modification which You create or to which You contribute must be

made available in Source Code form under the terms of this License

either on the same media as an Executable version or via an accepted

Electronic Distribution Mechanism to anyone to whom you made an

Executable version available; and if made

available via Electronic

Distribution Mechanism, must remain available for at least twelve (12)

months after the date it initially became available, or at least six

(6) months after a subsequent version of that particular Modification

has been made available to such recipients.

You are responsible for

ensuring that the Source Code version remains available even if the

Electronic Distribution Mechanism is maintained by a third party.

3.3. Description of Modifications.

You must cause all Covered Code to which You contribute to contain a

file documenting the changes You made to create that Covered Code and

the date of any change. You must include a prominent statement that

the Modification is derived, directly or indirectly, from Original

Code provided by the Initial Developer and including the name of the

Initial Developer in (a) the Source Code, and (b) in any notice in an

Executable version or related documentation in which You describe the

origin or ownership of the Covered Code.

3.4. Intellectual Property Matters

(a) Third Party Claims.

If Contributor has knowledge that a license under a third party's

intellectual property rights is required to exercise the rights

granted by such Contributor under Sections 2.1 or 2.2,

Contributor must include a text file with the Source Code

distribution titled "LEGAL" which describes the claim and the

party making the claim in sufficient detail that a recipient will

know whom to contact. If Contributor obtains such knowledge after

the Modification is made available as

described in Section 3.2,

Contributor shall promptly modify the LEGAL file in all copies

Contributor makes available thereafter and shall take other steps

(such as notifying appropriate mailing lists or newsgroups)

reasonably calculated to inform those who received the Covered

Code that new knowledge has been obtained.

(b) Contributor APIs.

If Contributor's Modifications include an application programming

interface and Contributor has knowledge of patent licenses which

are reasonably necessary to implement that API, Contributor must

also include this information in the LEGAL file.

(c) Representations.

Contributor represents that, except as disclosed pursuant to

Section 3.4(a) above, Contributor believes that Contributor's

Modifications are Contributor's original creation(s) and/or

Contributor has sufficient rights to grant the rights conveyed by

this License.

3.5. Required Notices.

You must duplicate the notice in Exhibit A in each file of the Source

Code. If it is not possible to put such notice in a particular Source

Code file due to its structure, then You must include such notice in a

location (such as a relevant directory) where a user would be likely

to look for such a notice. If You created one or more Modification(s)

You may add your name as a Contributor to the notice described in

Exhibit A. You must also duplicate this License in any documentation

for the Source Code where You describe recipients' rights or ownership

rights relating to Covered Code. You may choose to offer, and to

charge a fee for, warranty, support, indemnity or liability

obligations to one or more recipients of Covered Code. However, You

may do so only on Your own behalf, and not on behalf of the Initial

Developer or any Contributor. You must make it absolutely clear than

any such warranty, support, indemnity or liability obligation is

offered by You alone, and You hereby agree to indemnify the Initial

Developer and every Contributor for any liability incurred by the

Initial Developer or such Contributor as a result of warranty,

support, indemnity or liability terms You offer.

3.6. Distribution of Executable Versions.

You may distribute Covered Code in Executable form only if the

requirements of Section 3.1-3.5 have been met for that Covered Code,

and if You include a notice stating that the Source Code version of

the Covered Code is available under the terms of this License,

including a description of how and where You have fulfilled the

obligations of Section 3.2. The notice must be conspicuously included

in any notice in an Executable version, related documentation or

collateral in which You describe recipients' rights relating to the

Covered Code. You may distribute the Executable version of Covered

Code or ownership rights under a license of Your choice, which may

contain terms different from this License, provided that You are in

compliance with the terms of this License and that the license for the

Executable version does not attempt to limit or

alter the recipient's

rights in the Source Code version from the rights set forth in this

License. If You distribute the Executable version under a different

license You must make it absolutely clear that any terms which differ

from this License are offered by You alone, not by the Initial

Developer or any Contributor. You hereby agree to indemnify the

Initial Developer and every Contributor for any liability incurred by

the Initial Developer or such Contributor as a result of any such

terms You offer.

3.7. Larger Works.

You may create a Larger Work by combining Covered Code with other code

not governed by the terms of this License and distribute the Larger

Work as a single product. In such a case, You must make sure the

requirements of this License are fulfilled for the Covered Code.

If it is impossible for You to comply with any of the terms of this

License with respect to some or all of the Covered Code due to

statute, judicial order, or regulation then You must: (a) comply with

the terms of this License to the maximum extent possible; and (b)

describe the limitations and the code they affect. Such description

must be included in the LEGAL file described in Section 3.4 and must

be included with all distributions of the Source Code. Except to the

extent prohibited by statute or regulation, such description must be

sufficiently detailed for a recipient of ordinary skill to be able to

understand it.

This License applies to code to which the Initial Developer has

attached the notice in Exhibit A and to related Covered Code.

6.1. New Versions.

Netscape Communications Corporation ("Netscape") may publish revised

and/or new versions of the License from time to time. Each version

will be given a distinguishing version number.

6.2. Effect of New Versions.

Once Covered Code has been published under a particular version of the

License, You may always continue to use it under the terms of that

version. You may also choose to use such Covered Code under the terms

of any subsequent version of the License published by Netscape. No one

other than Netscape has the right to modify the terms applicable to

Covered Code created under this License.

6.3. Derivative Works.

If You create or use a modified version of this License (which you may

only do in order to apply it to code which is not already Covered Code

governed by this License), You must (a) rename Your license so that

the phrases "Mozilla", "MOZILLAPL", "MOZPL", "Netscape",

"MPL", "NPL" or any confusingly similar phrase do not appear in your

license (except to note that your license differs from this License)

and (b) otherwise make it clear that Your version of the license

contains terms which differ from the Mozilla Public License and

Netscape Public License. (Filling in the name of the Initial

Developer, Original Code or Contributor in the

notice described in

Exhibit A shall not of themselves be deemed to be modifications of

this License.)

COVERED CODE IS PROVIDED UNDER THIS LICENSE ON AN "AS IS" BASIS,

WITHOUT WARRANTY OF ANY KIND, EITHER EXPRESSED OR IMPLIED, INCLUDING,

WITHOUT LIMITATION, WARRANTIES THAT THE COVERED CODE IS FREE OF

DEFECTS, MERCHANTABILITY, FIT FOR A PARTICULAR PURPOSE OR NON-INFRINGEMENT.

THE ENTIRE RISK AS TO THE QUALITY AND PERFORMANCE OF THE COVERED CODE

IS WITH YOU. SHOULD ANY COVERED CODE PROVE DEFECTIVE IN ANY RESPECT,

YOU (NOT THE INITIAL DEVELOPER OR ANY OTHER CONTRIBUTOR) ASSUME THE

COST OF ANY NECESSARY SERVICING, REPAIR OR CORRECTION. THIS DISCLAIMER

OF WARRANTY CONSTITUTES AN ESSENTIAL PART OF THIS LICENSE. NO USE OF

ANY COVERED CODE IS AUTHORIZED HEREUNDER EXCEPT UNDER THIS DISCLAIMER.

8.1. This License and the rights granted hereunder will terminate

automatically if You fail to comply with terms herein and fail to cure

such breach within 30 days of becoming aware of the breach. All

sublicenses to the Covered Code which are properly granted shall

survive any termination of this License. Provisions which, by their

nature, must remain in effect beyond the termination of this License

shall survive.

8.2. If You initiate litigation by asserting a patent infringement

claim (excluding declaratory judgment actions) against Initial Developer

or a Contributor (the Initial Developer or Contributor against whom

You file such action is referred to as "Participant") alleging that:

(a) such Participant's Contributor Version directly or indirectly

infringes any patent, then any and all rights granted by such

Participant to You under Sections 2.1 and/or 2.2 of this License

shall, upon 60 days notice from Participant terminate prospectively,

unless if within 60 days after receipt of notice You either: (i)

agree in writing to pay Participant a mutually agreeable reasonable

royalty for Your past and future use of Modifications made by such

Participant, or (ii) withdraw Your litigation claim with respect to

the Contributor Version against such Participant. If within 60 days

of notice, a reasonable royalty and payment arrangement are not

mutually agreed upon in writing by the parties or the litigation claim

is not withdrawn, the rights granted by Participant to You under

Sections 2.1 and/or 2.2 automatically terminate at the expiration of

the 60 day notice period specified above.

(b) any software, hardware, or device, other than such Participant's

Contributor Version, directly or indirectly infringes any patent, then

any rights granted to You by such Participant under Sections 2.1(b)

and 2.2(b) are revoked effective as of the date You first made, used,

sold, distributed, or had made, Modifications made by that

Participant.

8.3. If You assert a patent infringement claim against Participant

alleging that such Participant's Contributor Version directly or

indirectly infringes any patent where such claim

is resolved (such as

by license or settlement) prior to the initiation of patent

infringement litigation, then the reasonable value of the licenses

granted by such Participant under Sections 2.1 or 2.2 shall be taken

into account in determining the amount or value of any payment or

license.

8.4. In the event of termination under Sections 8.1 or 8.2 above,

all end user license agreements (excluding distributors and resellers)

which have been validly granted by You or any distributor hereunder

prior to termination shall survive termination.

UNDER NO CIRCUMSTANCES AND UNDER NO LEGAL THEORY, WHETHER TORT

(INCLUDING NEGLIGENCE), CONTRACT, OR OTHERWISE, SHALL YOU, THE INITIAL

DEVELOPER, ANY OTHER CONTRIBUTOR, OR ANY DISTRIBUTOR OF COVERED CODE,

OR ANY SUPPLIER OF ANY OF SUCH PARTIES, BE LIABLE TO ANY PERSON FOR

ANY INDIRECT, SPECIAL, INCIDENTAL, OR CONSEQUENTIAL DAMAGES OF ANY

CHARACTER INCLUDING, WITHOUT LIMITATION, DAMAGES FOR LOSS OF GOODWILL,

WORK STOPPAGE, COMPUTER FAILURE OR MALFUNCTION, OR ANY AND ALL OTHER

COMMERCIAL DAMAGES OR LOSSES, EVEN IF SUCH PARTY SHALL HAVE BEEN

INFORMED OF THE POSSIBILITY OF SUCH DAMAGES. THIS LIMITATION OF

LIABILITY SHALL NOT APPLY TO LIABILITY FOR DEATH OR PERSONAL INJURY

RESULTING FROM SUCH PARTY'S NEGLIGENCE TO THE EXTENT APPLICABLE LAW

PROHIBITS SUCH LIMITATION. SOME JURISDICTIONS DO NOT ALLOW THE

EXCLUSION OR LIMITATION OF INCIDENTAL OR CONSEQUENTIAL DAMAGES, SO

THIS EXCLUSION AND LIMITATION MAY NOT APPLY TO YOU.

The Covered Code is a "commercial item," as that term is defined in

48 C.F.R. 2.101 (Oct. 1995), consisting of "commercial computer

software" and "commercial computer software documentation," as such

terms are used in 48 C.F.R. 12.212 (Sept. 1995). Consistent with 48

C.F.R. 12.212 and 48 C.F.R. 227.7202-1 through 227.7202-4 (June 1995),

all U.S. Government End Users acquire Covered Code with only those

rights set forth herein.

This License represents the complete agreement concerning subject

matter hereof. If any provision of this License is held to be

unenforceable, such provision shall be reformed only to the extent

necessary to make it enforceable. This License shall be governed by

California law provisions (except to the extent applicable law, if

any, provides otherwise), excluding its conflict-of-law provisions.

With respect to disputes in which at least one party is a citizen of,

or an entity chartered or registered to do business in the United

States of America, any litigation relating to this License shall be

subject to the jurisdiction of the Federal Courts of the Northern

District of California, with venue lying in Santa Clara County,

California, with the losing party responsible for costs, including

without limitation, court costs and reasonable attorneys' fees and

expenses. The application of the United Nations Convention on

Contracts for the International Sale of Goods is expressly excluded.

Any law or regulation which provides that the

language of a contract

shall be construed against the drafter shall not apply to this

License.

As between Initial Developer and the Contributors, each party is

responsible for claims and damages arising, directly or indirectly,

out of its utilization of rights under this License and You agree to

work with Initial Developer and Contributors to distribute such

responsibility on an equitable basis. Nothing herein is intended or

shall be deemed to constitute any admission of liability.

Initial Developer may designate portions of the Covered Code as

"Multiple-Licensed". "Multiple-Licensed" means that the Initial

Developer permits you to utilize portions of the Covered Code under

Your choice of the NPL or the alternative licenses, if any, specified

by the Initial Developer in the file described in Exhibit A.

EXHIBIT A -Mozilla Public License.

"The contents of this file are subject to the Mozilla Public License

Version 1.1 (the "License"); you may not use this file except in

compliance with the License. You may obtain a copy of the License at

<http://www.mozilla.org/MPL/>

Software distributed under the License is distributed on an "AS IS"

basis, WITHOUT WARRANTY OF ANY KIND, either express or implied. See the

License for the specific language governing rights and limitations

under the License.

The Original Code is _____.

The Initial Developer of the Original Code is

_____.

Portions created by _____ are Copyright (C) _____ All Rights Reserved.

Contributor(s): _____.

Alternatively, the contents of this file may be used under the terms

of the _____ license (the "[_____] License"), in which case the

provisions of [_____] License are applicable instead of those

above. If you wish to allow use of your version of this file only

under the terms of the [_____] License and not to allow others to use

your version of this file under the MPL, indicate your decision by

deleting the provisions above and replace them with the notice and

other provisions required by the [_____] License. If you do not delete

the provisions above, a recipient may use your version of this file

under either the MPL or the [_____] License."

[NOTE: The text of this Exhibit A may differ slightly from the text of

the notices in the Source Code files of the Original Code. You should

use the text of this Exhibit A rather than the text found in the

Original Code Source Code for Your Modifications.]

26.5

Announcements

You can receive an announcement on new TV software available for download or other software related issues.

To read these announcements...

- 1 - Press , select **All Settings** and press **OK**.
- 2 - Select **Update Software** > **Announcements**, and press **OK**.
- 3 - If there is an announcement, you can read it or select one of the announcements available.
- 4 - Press **◀** (left) repeatedly if necessary, to close the menu.

Specifications

27.1

Environmental

End of Use

Disposal of your old product and batteries

Your product is designed and manufactured with high quality materials and components, which can be recycled and reused.



When this crossed-out wheeled bin symbol is attached to a product it means that the product is covered by the European Directive 2012/19/EU.



Please inform yourself about the local separate collection system for electrical and electronic products.

Please act according to your local rules and do not dispose of your old products with your normal household waste. Correct disposal of your old product helps to prevent potential negative consequences for the environment and human health.

Your product contains batteries covered by the European Directive 2006/66/EC, which cannot be disposed with normal household waste.



Please find out for yourself about the local rules on separate collection of batteries because correct disposal will help to prevent negative consequences for the environment and human health.

27.2

Power

Product specifications are subject to change without notice. For more specification details of this product, see www.philips.com/support

Power

- Mains power : AC 110–240V +/-10%
- Ambient temperature : 5°C to 35°C
- Standby power consumption : < 0.5W
- Power saving features : Eco mode, Picture mute (for radio), Auto switch-off timer, Eco settings menu.

The power rating stated on the product typeplate is the power consumption for this product during normal household use (IEC 62087 Ed.2). The maximum power rating, stated between brackets, is used for electrical safety (IEC 60065 Ed. 7.2).

27.3

Operating System

Android OS :

Android Lollipop 5.1

27.4

Reception

- Aerial input : 75 ohm coaxial (IEC75)
- Tuner bands : Hyperband, S-Channel, UHF, VHF
- DVB : DVB-T2, DVB-C (cable) QAM
- Analogue video playback : SECAM, PAL
- Digital video playback : MPEG2 SD/HD (ISO/IEC 13818-2), MPEG4 SD/HD (ISO/IEC 14496-10)
- Digital audio playback (ISO/IEC 13818-3)

27.5

Display Type

Diagonal screen size

- 50PFT6200 : 126 cm / 50 inch
- 55PFT6200 : 139 cm / 55 inch

Display resolution

- 1920 x 1080p

27.6

Display Input Resolution

Video formats

Resolution — Refresh rate

- 480i - 60 Hz
- 480p - 60 Hz
- 576i - 50 Hz
- 576p - 50 Hz
- 720p - 50 Hz, 60 Hz
- 1080i - 50 Hz, 60 Hz
- 1080p - 24 Hz, 25 Hz, 30 Hz

Computer formats

Resolutions (amongst others)

- 640 x 480p – 60 Hz
- 800 x 600p – 60 Hz
- 1024 x 768p – 60 Hz
- 1280 x 768p – 60 Hz
- 1360 x 768p – 60 Hz
- 1280 x 1024p – 60 Hz
- 1600 x 1200p – 60 Hz
- 1920 x 1080p – 60 Hz

27.7

Dimensions and Weights

50PFT6200

- without TV stand:

Width 1123.6 mm – Height 646.7 mm – Depth 77 mm –

Weight ± 12.7 kg

- with TV stand:

Width 1123.6 mm – Height 709 mm – Depth 258.5 mm –

Weight ± 14.1 kg

55PFT6200

- without TV stand:

Width 1239.2 mm – Height 726 mm – Depth 79.2 mm –

Weight ± 15.1 kg

- with TV stand:

Width 1239.2 mm – Height 770.4 mm – Depth 266

mm – Weight ± 17.5 kg

27.8

Connectivity

TV Side

- Headphones – Stereo mini-jack 3.5mm
- HDMI 3 in – ARC
- HDMI 4 in – ARC/MHL
- 2x USB

TV Rear

- Audio In (DVI to HDMI) – Stereo mini-jack 3.5mm
- YPbPr : Y Pb Pr, Audio L/R

TV Bottom

- HDMI 1 in – ARC
- HDMI 2 in – ARC
- 1x USB
- Audio out – Optical
- Network LAN – RJ45
- Antenna (75Ω)

27.9

Multimedia

Connections

- USB 2.0
- Ethernet LAN RJ-45
- Wi-Fi 802.11a/b/g/n/ac (built-in)
- BT2.1 with EDR & BT4.0 with BLE

Supported USB file systems

- FAT 16, FAT 32, NTFS

Playback formats

- Containers : 3GP, AVCHD, AVI, MPEG-PS, MPEG-TS, MPEG-4, Matroska (MKV), Quicktime (MOV, M4V, M4A), Windows Media (ASF/WMV/WMA)
- Video Codecs : MPEG-1, MPEG-2, MPEG-4 Part 2, MPEG-4 Part 10 AVC (H264), H.265 (HEVC), VC-1, WMV9
- Audio Codecs : AAC, HE-AAC (v1/v2), AMR-NB, Dolby Digital, Dolby Digital Plus, DTS Premium Sound™, MPEG-1/2/2.5 Layer I/II/III (includes MP3), WMA (v2 to v9.2), WMA Pro (v9/v10)
- Subtitles :
 - Formats : SAMI, SubRip (SRT), SubViewer (SUB), MicroDVD (TXT), mplayer2 (TXT), TMPlayer (TXT)
 - Character encodings : UTF-8, Central Europe and Eastern Europe (Windows-1250), Cyrillic (Windows-1251), Greek (Windows-1253), Turkish (Windows-1254), Western Europe (Windows-1252)
- Image Codecs : JPEG, JPS, MPO
- Limitations :
 - Maximum supported total bit rate for a media file is 30Mbps.
 - Maximum supported video bit rate for a media file is 20Mbps.
 - MPEG-4 AVC (H.264) is supported up to High Profile @ L5.1.
 - H.265 (HEVC) is supported upto Main / Main 10 Profile up to Level 5.1
 - VC-1 is supported up to Advanced Profile @ L3.

Wi-Fi Certified

This TV supports Miracast certified devices.

Supported media server software (DMS)

- You can use any DLNA V1.5 certified media server software (DMS class).
- You can use the Philips TV Remote app (iOS and Android) on mobile devices.

Performance may vary, depending on the capabilities of the mobile device and the software used.

ESD regulations

This apparatus meets performance criteria B for ESD. In case the apparatus does not recover in file sharing mode due to electrostatic discharge, user interference is required.

Help and Support

28.1

Register your TV

Register your TV and enjoy a range of benefits including full support (including downloads), privileged access to information about new products, exclusive offers and discounts, the chance to win prizes and even participate in special surveys about new releases.



Go to www.philips.com/welcome

28.2

Using Help

This TV offers help on screen .

Open Help

Press the  key (blue) to open Help immediately. Help will open on the chapter that is most relevant to what you are doing or what is selected on TV. To look up topics alphabetically, press the colour key  **Keywords**.

To read the Help as a book, select **Book**.

You can also open  **Help** in the Home menu or TV menu.

Before you execute the Help instructions, close Help. To close Help, press the colour key  **Close**.

For some activities, like Text (Teletext), the colour keys have specific functions and cannot open Help.

TV Help on your tablet, smartphone or computer

To carry out extended sequences of instructions more easily, you can download the TV Help in PDF format to read on your smartphone, tablet or computer. Alternatively, you can print the relevant Help page from your computer.

To download the Help (user manual) go to www.philips.com/support

MTK_v46_20160518

28.3

Troubleshooting

Switch On and Remote Control

The TV does not switch on

- Disconnect the power cable from the power outlet. Wait for one minute then reconnect it.
- Make sure that the power cable is securely connected.

Creaking sound at startup or switch off

When you are switching the TV on, off or to standby, you hear a creaking sound from the TV chassis. The creaking sound is due to the normal expansion and contraction of the TV as it cools and warms up. This does not affect performance.

TV does not respond to the remote control

The TV requires some time to start up. During this time, the TV does not respond to the remote control or TV controls. This is normal behaviour. If the TV continues to be unresponsive to the remote control, you can check if the remote control is working by means of a mobile phone camera. Put the phone in camera mode and point the remote control to the camera lens. If you press any key on the remote control and you notice the infra red LED flicker through the camera, the remote control is working. The TV needs to be checked.

If you do not notice the flickering, the remote control might be broken or its batteries are low.

This method of checking the remote control is not possible with remote controls which are wirelessly paired with the TV.

The TV goes back to standby after showing the Philips startup screen

When the TV is in standby, a Philips startup screen is displayed, then the TV returns to standby mode. This is normal behaviour. When the TV is disconnected and reconnected to the power supply, the startup screen is displayed at the next startup. To switch on the TV from standby, press  on the remote control or on the TV.

The standby light keeps on blinking

Disconnect the power cable from the power outlet. Wait 5 minutes before you reconnect the power cable. If the blinking reoccurs, contact Philips TV Consumer Care.

Channels

No digital channels found during the installation

See the technical specifications to make sure that your TV supports DVB-T or DVB-C in your country. Make sure that all cables are properly connected and that the correct network is selected.

Previously installed channels are not in the channel

list

Make sure that the correct channel list is selected.

Picture

No picture / distorted picture

- Make sure that the antenna is properly connected to the TV.
- Make sure that the correct device is selected as the display source.
- Make sure that the external device or source is properly connected.

Sound but no picture

- Make sure that the picture settings are set correctly.

Poor antenna reception

- Make sure that the antenna is properly connected to the TV.
- Loud speakers, unearthed audio devices, neon lights, high buildings and other large objects can influence reception quality. If possible, try to improve the reception quality by changing the antenna direction or moving devices away from the TV.
- If reception on only one channel is poor, fine-tune this channel with Manual Installation.

Poor picture from a device

- Make sure that the device is connected properly.
- Make sure that the picture settings are set correctly.

Picture settings change after a while

Make sure that **Location** is set to **Home**. You can change and save settings in this mode.

A commercial banner appears

Make sure that **Location** is set to **Home**.

Picture does not fit the screen

Change to a different picture format.

Picture format keeps changing with different channels

Select a non 'Auto' picture format.

Picture position is incorrect

Picture signals from some devices may not fit the screen correctly. Check the signal output of the connected device.

Computer picture is not stable

Make sure that your PC uses the supported resolution and refresh rate.

Sound

No sound or poor sound quality

If no audio signal is detected, the TV automatically switches the audio output off — this does not indicate malfunction.

- Make sure that the sound settings are correctly set.
- Make sure that all cables are properly connected.
- Make sure that the volume is not muted or set to zero.
- Make sure that the TV audio output is connected to the audio input on the Home Theatre System. Sound should be heard from the HTS speakers.
- Some devices may require you to manually enable HDMI audio output. If HDMI audio is already enabled, but you still do not hear audio, try changing the digital audio format of the device to PCM (Pulse Code Modulation). Refer to the documentation accompanying your device for instructions.

HDMI and USB

HDMI

- Note that HDCP (High-bandwidth Digital Content Protection) support can delay the time taken for a TV to display content from an HDMI device.
- If the TV does not recognise the HDMI device and no picture is displayed, switch the source from one device to another and back again.
- If there are intermittent sound disruptions, make sure that output settings from the HDMI device are correct.
- If you use an HDMI-to-DVI adapter or HDMI-to-DVI cable, make sure that an additional audio cable is connected to AUDIO IN (mini-jack only), if available.

HDMI EasyLink does not work

- Make sure that your HDMI devices are HDMI-CEC compatible. EasyLink features only work with devices that are HDMI-CEC compatible.

No volume icon shown

- When an HDMI-CEC audio device is connected and you use the TV Remote Control to adjust the volume level from the device, this behaviour is normal.

Photos, videos and music from a USB device do not show

- Make sure that the USB storage device is set to Mass Storage Class compliant, as described in the storage device's documentation.
- Make sure that the USB storage device is compatible with the TV.
- Make sure that the audio and picture file formats are supported by the TV.

Choppy playback of USB files

- The transfer performance of the USB storage device may limit the data transfer rate to the TV which causes poor playback.

Wi-Fi, Internet and Bluetooth

Wi-Fi network not found or distorted

- Microwave ovens, DECT phones or other Wi-Fi 802.11b/g/n devices in your proximity might disturb the wireless network.
- Make sure that the firewalls in your network allow access to the TV's wireless connection.
- If the wireless network does not work properly in your home, try the wired network installation.

Internet does not work

- If the connection to the router is OK, check the router connection to the Internet.

The PC and Internet connection are slow

- Look in your wireless router's user manual for information on indoor range, transfer rate and other factors of signal quality.
- Use a high-speed (broadband) Internet connection for your router.

DHCP

- If the connection fails, you can check the DHCP (Dynamic Host Configuration Protocol) setting of the router. DHCP should be switched on.

Bluetooth lost connection

- Position the wireless speaker within a range of 5 meters from the TV.
- Places with a high amount of wireless activity - apartments with lots of wireless routers - can hamper the wireless connection. Keep the router and wireless speaker as close to the TV as possible.





Bluetooth Audio and Video synchronisation

- Before you purchase a wireless Bluetooth speaker, inform yourself about its quality of Audio to Video synchronisation, commonly called 'lip sync'. Not all Bluetooth devices perform correctly. Ask your dealer for advice.

Wrong Menu Language

Wrong menu language

Change the language back to your language.

- 1 - Press  (the round key above the OK key).
- 2 - Select the  icon (Settings) and press OK.
- 3 - Press 5 times  (down).
- 4 - Press 3 times  (right), select your language and press OK.
- 5 - Press  BACK to close the menu.

28.4

Online Help

To solve any Philips TV related problem, you can consult our online support. You can select your language and enter your product model number.

Go to www.philips.com/support .

On the support site you can find your country's telephone number to contact us as well as answers to frequently asked questions (FAQs). In some countries, you can chat with one of our collaborators and ask your question directly or send a question by email. You can download new TV software or the manual to read on your computer.

28.5

Support and Repair

For support and repair, call the Consumer Care hotline in your country. Our service engineers will take care of a repair, if necessary.

Find the telephone number in the printed documentation that came with the TV.

Or consult our website www.philips.com/support and select your country if needed.

Support app

You can also look up the Support app in the Apps row of the Home menu.

Open this app to find the telephone number to contact us.

TV model number and serial number

You might be asked to provide the TV product model number and serial number. Find these numbers on the packaging label or on the type label on the back or bottom of the TV.

Warning

Do not attempt to repair the TV yourself. This may cause severe injury, irreparable damage to your TV or void your warranty.

Safety and Care

29.1

Safety

Important

Read and understand all safety instructions before you use the TV. If damage is caused by failure to follow instructions, the warranty does not apply.

Secure the TV from Falling Over

Always use the supplied wall bracket to secure the TV from falling over. Mount the bracket and secure the TV onto the bracket, even if you put the TV on the floor.

You can find the mounting instructions in the Quick Start Guide that came with the TV. In case you lost this guide, you can download the guide from www.philips.com. Use the product type number of the TV to look for the Quick Start Guide to download.

Risk of Electric Shock or Fire

- Never expose the TV to rain or water. Never place liquid containers, such as vases, near the TV. If liquids are spilt on or into the TV, disconnect the TV from the power outlet immediately. Contact Philips TV Consumer Care to have the TV checked before use.
- Never expose the TV, remote control or batteries to excessive heat. Never place them near burning candles, naked flames or other heat sources, including direct sunlight.
- Never insert objects into the ventilation slots or other openings on the TV.
- Never place heavy objects on the power cord.
- Avoid force coming onto power plugs. Loose power plugs can cause arcing or fire. Ensure that no strain is exerted on the power cord when you swivel the TV screen.
- To disconnect the TV from the mains power, the power plug of the TV must be disconnected. When disconnecting the power, always pull the power plug, never the cord. Ensure that you have full access to the power plug, power cord and outlet socket at all times.

Risk of Injury or Damage to the TV

- Two people are required to lift and carry a TV that weighs more than 25 kg or 55 lbs.
- If you mount the TV on a stand, only use the supplied stand. Secure the stand to the TV tightly. Place the TV on a flat, level surface that can support the weight of the TV and the stand.
- When wall mounted, ensure that the wall mount can safely bear the weight of the TV set. TP Vision bears no responsibility for improper wall mounting that results in accident, injury or damage.
- Parts of this product are made of glass. Handle with care to avoid injury or damage.

Risk of damage to the TV !

Before you connect the TV to the power outlet, ensure that the power voltage matches the value printed on the back of the TV. Never connect the TV to the power outlet if the voltage is different.

Risk of Injury to Children

Follow these precautions to prevent the TV from toppling over and causing injury to children:

- Never place the TV on a surface covered by a cloth or other material that can be pulled away.
- Ensure that no part of the TV hangs over the edge of the mounting surface.
- Never place the TV on tall furniture, such as a bookcase, without anchoring both the furniture and TV to the wall or a suitable support.
- Teach children about the dangers of climbing on furniture to reach the TV.

Risk of swallowing batteries !

The remote control may contain coin-type batteries which can easily be swallowed by small children. Keep these batteries out of reach of children at all times.

Risk of Overheating

Never install the TV in a confined space. Always leave a space of at least 10 cm or 4 inches around the TV for ventilation. Ensure curtains or other objects never cover the ventilation slots on the TV.

Lightning Storms

Disconnect the TV from the power outlet and antenna before lightning storms.

During lightning storms, never touch any part of the TV, power cord or antenna cable.

Risk of Hearing Damage

Avoid using earphones or headphones at high volumes or for prolonged periods of time.

Low Temperatures

If the TV is transported in temperatures below 5°C or 41°F, unpack the TV and wait until the TV temperature reaches room temperature before connecting the TV to the power outlet.

Humidity

In rare occasions, depending on temperature and humidity, minor condensation can occur on the inside of the TV glass front (on some models). To prevent this, do not expose the TV to direct sunlight, heat or extreme humidity. If condensation occurs, it will disappear spontaneously while the TV is playing for a few hours.

The condensation moisture will not harm the TV or cause malfunction.

29.2

Screen Care

- Never touch, push, rub or strike the screen with any object.
- Unplug the TV before cleaning.
- Clean the TV and frame with a soft damp cloth and wipe gently. Avoid touching the Ambilight LEDs on the backside of the TV. Never use substances such as alcohol, chemicals or household cleaners on the TV.
- To avoid deformations and colour fading, wipe off water drops as quickly as possible.
- Avoid stationary images as much as possible.

Stationary images are images that remain onscreen for extended periods of time. Stationary images include onscreen menus, black bars, time displays, etc. If you must use stationary images, reduce screen contrast and brightness to avoid screen damage.

Terms of Use

30.1

Terms of Use – TV

2015 © TP Vision Europe B.V. All rights reserved.

This product was brought to the market by TP Vision Europe B.V. or one of its affiliates, hereinafter referred to as TP Vision, which is the manufacturer of the product. TP Vision is the warrantor in relation to the TV with which this booklet was packaged. Philips and the Philips Shield Emblem are registered trademarks of Koninklijke Philips N.V.

Specifications are subject to change without notice. Trademarks are the property of Koninklijke Philips N.V or their respective owners. TP Vision reserves the right to change products at any time without being obliged to adjust earlier supplies accordingly.

The written material packaged with the TV and the manual stored in the memory of the TV or downloaded from the Philips website www.philips.com/support are believed to be adequate for the intended use of the system.

The material in this manual is believed adequate for the intended use of the system. If the product, or its individual modules or procedures, are used for purposes other than those specified herein, confirmation of their validity and suitability must be obtained. TP Vision warrants that the material itself does not infringe any United States patents. No further warranty is expressed or implied. TP Vision cannot be held responsible neither for any errors in the content of this document nor for any problems as a result of the content in this document. Errors reported to Philips will be adapted and published on the Philips support website as soon as possible.

Terms of warranty – Risk of injury, damage to TV or void of warranty!

Never attempt to repair the TV yourself. Use the TV and accessories only as intended by the manufacturer. The caution sign printed on the back of the TV indicates risk of electric shock. Never remove the TV cover. Always contact Philips TV Customer Care for service or repairs. Find the telephone number in the printed documentation that came with the TV. Or consult our website www.philips.com/support and select your country if needed. Any operation expressly prohibited in this manual, or any adjustments and assembly procedures not recommended or authorised in this manual, shall void the warranty.

Pixel characteristics

This LCD/LED product has a high number of colour pixels. Although it has effective pixels of 99.999% or

more, black dots or bright points of light (red, green or blue) may appear constantly on the screen. This is a structural property of the display (within common industry standards) and is not a malfunction.

CE compliance

This product is in compliance with the essential requirements and other relevant provisions of Directives 2006/95/EC (Low Voltage), 2004/108/EC (EMC) and 2011/65/EU (ROHS).

Compliance with EMF

TP Vision manufactures and sells many products targeted at consumers which, like any electronic apparatus, in general have the ability to emit and receive electromagnetic signals. One of TP Vision's leading business principles is to take all necessary health and safety measures for our products, to comply with all applicable legal requirements and to stay well within the Electro Magnetic Field (EMF) standards applicable at the time of producing the products.



TP Vision is committed to developing, producing and marketing products that cause no adverse health effects. TP Vision confirms that, as long as its products are handled properly for their intended use, they are safe to use according to scientific evidence available today. TP Vision plays an active role in the development of international EMF and safety standards, enabling TP Vision to anticipate further developments in standardisation for early integration in its products.

30.2

Terms of Use – Smart TV

You can see the terms of use, privacy policy, and also set privacy settings of your Smart TV.

To open the terms of use of Smart TV page...

- 1 - Press  HOME to open the Home menu.
- 2 - Select  Apps to open Apps.
- 3 - Select Support.

30.3

Terms of Use – Philips App Gallery

In Help, press the colour key  Keywords and look up Terms of Use, App Gallery for more information.

Copyrights

MHL

MHL, Mobile High-Definition Link and the MHL Logo are trademarks or registered trademarks of the MHL, LLC.



HDMI



HDMI®

The terms HDMI and HDMI High-Definition Multimedia Interface, and the HDMI Logo are trademarks or registered trademarks of HDMI Licensing LLC in the United States and other countries.

Dolby Digital Plus



Dolby®

Manufactured under license from Dolby Laboratories. Dolby and the double-D symbol are trademarks of Dolby Laboratories.

DTS Premium Sound™



DTS Premium Sound™

For DTS patents, see <http://patents.dts.com>. Manufactured under license from DTS Licensing Limited. DTS, the Symbol, & DTS and the Symbol together are registered trademarks, and DTS 2.0 Channel is a trademark of DTS, Inc. © DTS, Inc. All Rights Reserved.

Microsoft



Windows Media

Windows Media is either a registered trademark or trademark of Microsoft Corporation in the United States and/or other countries.

Microsoft PlayReady

Content owners use Microsoft PlayReady™ content access technology to protect their intellectual property, including copyrighted content. This device uses PlayReady technology to access PlayReady-protected content and/or WMDRM-protected content. If the device fails to properly enforce restrictions on content usage, content owners may require Microsoft to revoke the device's ability to consume PlayReady-protected content. Revocation should not affect unprotected content or content protected by other content access technologies. Content owners may require you to upgrade PlayReady to access their content. If you decline an upgrade, you will not be able to access content that requires the upgrade.

31.6

Wi-Fi Alliance



Wi-Fi®, the Wi-Fi CERTIFIED logo, the Wi-Fi logo are registered trademarks of the Wi-Fi Alliance.

31.7

Kensington

(If applicable)



Kensington and Micro Saver are registered US trademarks of ACCO World Corporation with issued registrations and pending applications in other countries throughout the world.

31.8

Other Trademarks

All other registered and unregistered trademarks are the property of their respective owners.

Index

A

- Age Rating 29
- Android Settings 11
- Announcements 114
- Antenna connection 7
- Antenna, Manual Installation 79
- APP lock 50
- Apps 48
- Audio commentary 73
- Audio Description 73
- Audio Language 30
- Audio Language, Primary 30
- Audio Language, Secondary 30
- Audio Out - Optical, tips 15
- Audio Out Delay 16
- Audio Out Format 17
- Audio Out Levelling 17
- Audio Out Offset 16
- Audio Out Settings 16
- Audio to Video Sync 16
- Auto Volume Levelling 65
- Automatic Channel Update 77
- Automatic switch off 24

B

- Backlight Contrast 61
- Bass 65
- Blu-ray Disc player, connect 17
- Bluetooth 18
- Bluetooth, Devices 18
- Bluetooth, Pairing 18
- Bluetooth, Remove device 19
- Bluetooth, Select device 18

C

- Cable, Manual Installation 79
- Camcorder, connect 22
- Channel 28
- Channel List 28
- Channel List Copy 79
- Channel List Copy, copy 79
- Channel List Copy, current version 79
- Channel List Copy, upload 80
- Channel List, about 28
- Channel List, filter 28
- Channel List, open 28
- Channel List, search 28
- Channel logos 69
- Channel Update Message 77
- Channel, age rating 29
- Channel, Antenna Installation 77
- Channel, Automatic Channel Update 77
- Channel, Cable Installation 77
- Channel, Manual channel update 77
- Channel, Options 30
- Channel, Reinstall 77
- Channel, switch to a channel 29
- Channel, TV guide 35
- Channels, watch two channels 60
- Child Lock 69
- Clear Internet Memory 10
- Clear Miracast connection 10

- Clear Sound 65
- Colour 61
- Colour, Colour enhancement 62
- Colour, colour temperature 62
- Colour, custom colour temperature 62
- Computer, connect 22
- Connect DVD player 18
- Connectivity Guide 13
- Consumer Care 120
- Contact Philips 120
- Contrast 61
- Contrast, Contrast Mode 62
- Contrast, Dynamic Contrast 63
- Contrast, Gamma 63
- Contrast, Perfect Contrast 63
- Contrast, Video Contrast 63

D

- Digital Text 32
- Disposal of TV or batteries 116
- DMR, Digital Media Renderer 10
- DVB (Digital Video Broadcast) 78

E

- EasyLink 13
- EasyLink, On or Off 14
- EasyLink, Remote control 14
- Eco Settings 67
- End of use 116

F

- FreeviewPlus 45
- Frequency Scan 78
- Frequency Step Size 78

G

- Game Console, connect 19
- Game or Computer 46
- Game or Computer, setting 62
- Gamepad, connect 20
- Gamma 63
- Google Play Store 49

H

- Hard of hearing 73
- HbbTV 34
- HDMI MHL 13
- HDMI, ARC 13
- HDMI, DVI connection 14
- Headphones Volume 66
- Headphones, connect 19
- Hearing impaired 73
- Home Menu 42
- Home Theatre System, Multichannel 17
- Home Theatre System, problems 17
- Home Theatre System, sound 66
- Home Theatre System, volume levelling 17

I

- Incredible Surround 65
- Interactive TV 34
- Interactive TV, about 33
- Internet memory, clear 9

I

iTV 33

K

Keys on TV 24

M

Media 54

Media files, from a cloud storage 54

Media files, from a computer or NAS 54

Media files, from a USB drive 54

Miracast™, switch on 57

MPEG Artefact Reduction 64

Multi View 60

N

Network Frequency 78

Network Frequency Mode 78

Network Installation 8

Network, Clear Wi-Fi Miracast connection 10

Network, connect 8

Network, settings 9

Network, Static IP 9

Network, Switch on Wi-Fi 10

Network, TV Network Name 10

Network, View Settings 9

Network, Wi-Fi Smart Screen 10

Network, Wired 9

Network, Wireless 8

Network, WoWLAN 9

Network, WPS 8

Network, WPS with PIN code 8

Noise Reduction 63

Now on TV 40

O

On a TV stand, TV Placement 69

On and Off 24

On the wall, TV Placement 69

Online support 120

Open Source software 81

Options on a Channel 30

P

Parental Rating 29

Partially sighted 73

Photo camera, connect 22

Photos, Videos and Music 54

Picture Format 64

Picture Format, advanced 64

Picture Format, basic 64

Picture In Picture 60

Picture Style 61

Picture, Backlight Contrast 61

Picture, Colour 61

Picture, quick settings 64

Picture, Sharpness 61

Placement, TV placement 6

Placement, Viewing distance 6

Power connection 6

Power consumption check 67

Problems 118

Problems, Channels 118

Problems, Connection, Internet 120

Problems, Connection, Wi-Fi 120

Problems, HDMI 119

Problems, Menu language 120

Problems, Picture 119

Problems, Remote control 118

Problems, Sound 119

Problems, USB 119

Product Fiche 116

Programmes, Recommendations 40

R

Radio stations 28

Reception Quality 78

Recording 37

Recording, TV Guide data 35

Register your product 118

Reinstall TV 77

Remote control and batteries 27

Repair 120

S

Safety Instructions 121

Screen care 122

Sharpness 61

Sharpness, MPEG Artefact Reduction 64

Sharpness, Noise reduction 63

Sharpness, Super Resolution 63

Sleep Timer 24

Software, Update 81

Sound Style 64

Sound, Auto Volume Levelling 65

Sound, Bass 65

Sound, Clear Sound 65

Sound, Headphones Volume 66

Sound, surround mode 65

Sound, Treble 65

Speakers, Wireless 66

Standby 24

Subtitle 30

Subtitle Language 30

Subtitle Language, Primary 30

Subtitle Language, Secondary 30

Support, online 120

Surround Mode 65

Switch Off Timer 24

Synchronise Audio and Video 16

T

Teletext 32

Terms of Use 123

Terms of Use, App Gallery 11

Test Reception 78

Text 32

Text language, Primary 33

Text language, Secondary 33

Treble 65

TV Guide 35

TV Guide, data and information 35

TV Guide, Reminder 35

TV Installation 77

TV network name 9

TV on Demand 40

TV Speakers 66

U

Universal Access 73

Universal Access, Hard of hearing 73

Universal Access, Speakers/Headphones 74

USB Flash Drive, connect 22

USB Hard Drive, disk space 20

USB Hard Drive, Installation 20

USB Keyboard 21

USB Keyboard, connect 21

V

Video on Demand 41

Video Selection 31

Visually impaired 73

Voice Search 26

W

Watch TV 29

Wi-Fi 8

Wired Network 9

Wireless Audio 66

Wireless Network 8

Wireless Speakers, about 66

Wireless Speakers, select 67

WoWLAN 9

Y

YPbPr connection, tips 15

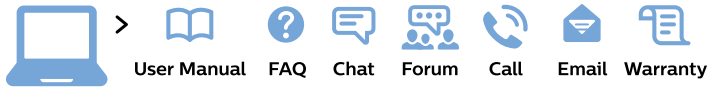

www.philips.com/support



All registered and unregistered trademarks are property of their respective owners. Specifications are subject to change without notice. Philips and the Philips' shield emblem are trademarks of Koninklijke Philips N.V. and are used under license from Koninklijke Philips N.V. 2015 © TP Vision Europe B.V. All rights reserved.
philips.com