

PHILIPS

Televisions

4000 series

32PFL4901



Register your product and get support at

www.philips.com/welcome

EN User Manual

To obtain a more detailed Electronic Copy of this Manual or to access live chat support, go to www.philips.com/support

ES Manual del Usuario

Para obtener una copia electrónica más detallada de este Manual de usuario o para tener acceso al soporte de chat en vivo, vaya a www.philips.com/support

FR Manuel d'Utilisation

Pour obtenir une copie électronique plus détaillée de ce guide ou accéder au soutien par clavardage en direct, visitez le www.philips.com/support

EN For further assistance, call the customer support service in your country.

• To obtain assistance, contact Philips Customer Care Center; In the U.S.A., Canada, Puerto Rico, or the U.S. Virgin Islands **1 866 813 3283**
México D.F. and Área Metropolitana: **58 87 97 36**
Interior de la Republica; **01 800 839 19 89**

ES Para obtener más información, llame al servicio de soporte al cliente de su país.

• Para obtener asistencia, comuníquese con Centro de atención al cliente de Philips; En los Estados Unidos, en Canadá, Puerto Rico o en las Islas Vírgenes de los Estados Unidos; **1 866 813 3283**
México D.F. y Área Metropolitana; **58 87 97 36**
Interior de la Republica; **01 800 839 19 89**

FR Pour obtenir de l'aide supplémentaire, communiquez avec le centre de service à la clientèle de votre pays.

• Pour obtenir de l'aide, communiquez avec le centre de service à la clientèle Philips au; Dans le États-Unis, au Canada, à Puerto Rico ou aux îles Vierges américaines; **1 866 813 3283**
México D.F. et Área Metropolitana; **58 87 97 36**
Interior de la Republica; **01 800 839 19 89**

Register Online at www.philips.com/welcome today to get the most benefits from your purchase.

Registering your model with Philips makes you eligible for all of the valuable benefits listed below, so don't miss out.
Register Online at www.philips.com/welcome to ensure:

*Product Safety Notification

By Registering your Product, you'll receive notification - directly from the manufacturer - in the rare case of a Product Recall or Safety Defect.

*Additional Benefits

Registering your Product guarantees that you'll receive all of the Privileges to which you're Entitled, including special money-saving offers.

Know these *safety* symbols



The caution marking is located on the rear or bottom of the cabinet.



The lightning flash with arrowhead symbol, within an equilateral triangle, is intended to alert the user to the presence of uninsulated "dangerous voltage" within the apparatus's enclosure that may be of sufficient magnitude to constitute a risk of electric shock to persons.



The exclamation point within an equilateral triangle is intended to alert the user to the presence of important operating and maintenance (servicing) instructions in the literature accompanying the apparatus.

WARNING: To reduce the risk of fire or electric shock, do not expose this apparatus to rain or moisture. Apparatus shall not be exposed to dripping or splashing and no objects filled with liquids, such as vases, shall be placed on the apparatus.

CAUTION: To prevent electric shock, match wide blade of plug to wide slot, fully insert.

ATTENTION: Pour éviter les choc électriques, introduire la lame la plus large de la fiche dans la borne correspondante de la prise et pousser jusqu'au fond.

PHILIPS For fastest support visit us online for chat and self service
solutions at www.philips.com/support

CHILD SAFETY:

PROPER TELEVISION PLACEMENT MATTERS

THE CONSUMER ELECTRONICS INDUSTRY CARES

- Manufacturers, retailers and the rest of the consumer electronics industry are committed to making home entertainment safe and enjoyable.
- As you enjoy your television, please note that all televisions – new and old- must be supported on proper stands or installed according to the manufacturer's recommendations. Televisions that are inappropriately situated on dressers, bookcases, shelves, desks, speakers, chests, carts, etc., may fall over, resulting in injury.

TUNE IN TO SAFETY

- **ALWAYS** follow the manufacturer's recommendations for the safe installation of your television.
- **ALWAYS** read and follow all instructions for proper use of your television.
- **NEVER** allow children to climb on or play on the television or the furniture on which the television is placed.
- **NEVER** place the television on furniture that can easily be used as steps, such as a chest of drawers.
- **ALWAYS** install the television where it cannot be pushed, pulled over or knocked down.
- **ALWAYS** route cords and cables connected to the television so that they cannot be tripped over, pulled or grabbed.

WALL OR CEILING MOUNT YOUR TELEVISION

- **ALWAYS** contact your retailer about professional installation if you have any doubts about your ability to safely mount your television.
- **ALWAYS** use a mount that has been recommended by the television manufacturer and has a safety certification by an independent laboratory (such as UL, CSA, ETL).
- **ALWAYS** follow all instructions supplied by the television and mount manufacturers.
- **ALWAYS** make sure that the wall or ceiling where you are mounting the television is appropriate. Some mounts are not designed to be mounted to walls and ceilings with steel studs or cinder block construction. If you are unsure, contact a professional installer.
- Televisions can be heavy. A minimum of two people is required for a wall or ceiling mount installation.

MOVING AN OLDER TELEVISION TO A NEW PLACE IN YOUR HOME

- Many new television buyers move their older CRT televisions into a secondary room after the purchase of a flat-panel television. Special care should be made in the placement of older CRT televisions.
- **ALWAYS** place your older CRT television on furniture that is sturdy and appropriate for its size and weight.
- **NEVER** place your older CRT television on a dresser where children may be tempted to use the drawers to climb.
- **ALWAYS** make sure your older CRT television does not hang over the edge of your furniture.



Important Safety Instructions

1. Read these instructions.
2. Keep these instructions.
3. Heed all warnings.
4. Follow all instructions.
5. Do not use this apparatus near water.
6. Clean only with dry cloth.
7. Do not block any ventilation openings. Install in accordance with the manufacturer's instructions.
8. Do not install near any heat sources such as radiators, heat registers, stoves, or other apparatus (including amplifiers) that produce heat.
9. Do not defeat the safety purpose of the polarized or grounding type plug. A polarized plug has two blades with one wider than the other. A grounding type plug has two blades and a third grounding prong. The wide blade or the third prong are provided for your safety. If the provided plug does not fit into your outlet, consult an electrician for replacement of the obsolete outlet.
10. Protect the power cord from being walked on or pinched particularly at plugs, convenience receptacles, and the point where they exit from the apparatus.
11. Only use attachments / accessories specified by the manufacturer.
12. Use only with the cart, stand, tripod, bracket, or table specified by the manufacturer, or sold with the apparatus. When a cart is used, use caution when moving the cart / apparatus combination to avoid injury from tip-over.



13. Unplug this apparatus during lightning storms or when unused for long periods of time.
14. Refer all servicing to qualified service personnel. Servicing is required when the apparatus has been damaged in any way, such as power-supply cord or plug is damaged, liquid has been spilled or objects have fallen into the apparatus, the apparatus has been exposed to rain or moisture, does not operate normally, or has been dropped.

Note to the CATV system installer:

This reminder is provided to call the CATV system installer's attention to Article 820-40 of the NEC that provides guidelines for proper grounding and, in particular, specifies that the cable ground shall be connected to the grounding system of the building, as close to the point of cable entry as practical.

Example of Antenna Grounding as per NEC - National Electric Code

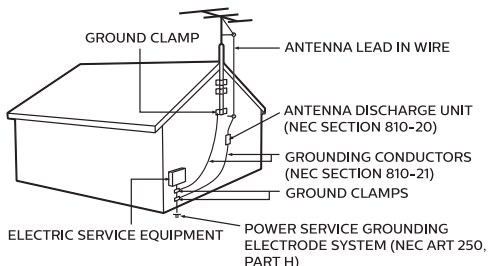

English

Wall Mount Bracket Kit

	Brand	Model #	Screw dimension
32PFL4901	SANUS	AST16	M4 x 0.472" (12mm)

- The recommended Wall Mount Bracket Kit (sold separately) allows the mounting of the TV on the wall.
- For detailed information on installing the wall mount, refer to the Wall Mount Instruction Book.
- P&F USA is not responsible for any damage to the product or injury to yourself or others if you elect to install the TV Wall Mount Bracket or mount the TV onto the Bracket on your own.
- The Wall Mount Bracket must be installed by experts.

P&F USA is not liable for these types of accidents or injuries noted below.

- Install the Wall Mount Bracket on a sturdy vertical wall.
- If installed onto a ceiling or slanted wall, the TV and Wall Mount Bracket may fall which could result in a severe injury.
- Do not use screws that are longer or shorter than their specified length. If screws too long are used this may cause mechanical or electrical damage inside the TV set. If screws too short are used this may cause the TV set to fall.
- Do not fasten the screws by excessive force. This may damage the product or cause the product to fall, leading to an injury.
- For safety reasons use 2 people to mount the TV onto a Wall Mounting Bracket.
- Do not mount the TV onto the Wall Mounting Bracket while your TV is plugged in or Turned On. It may result in an electrical shock injury.

When installing the unit on the wall, allow this much space.

Top:	11.8 inches (30cm)
Left and right side:	5.9 inches (15cm)
Bottom:	3.9 inches (10cm)

1 Notice

Trademarks are the property of Koninklijke Philips N.V. or their respective owners.

P&F USA reserves the right to change products at any time without being obliged to adjust earlier supplies accordingly. The material in this manual is believed adequate for the intended use of the system. If the product or its individual modules or procedures are used for purposes other than those specified herein, confirmation of their validity and suitability must be obtained. P&F USA warrants that the material itself does not infringe any United States patents. No further warranty is expressed or implied.

P&F USA cannot be held responsible neither for any errors in the content of this document nor for any problems as a result of the content in this document. Errors reported to P&F USA will be adapted and published on the P&F USA support website as soon as possible.

Pixel characteristics

This LCD product has a high number of color pixels. Although it has effective pixels of 99.999% or more, black dots or bright points of light (red, green or blue) may appear constantly on the screen. This is a structural property of the display (within common industry standards) and is not a malfunction.

Warranty

No components are user serviceable. Do not open or remove covers to the inside of the product. Repairs may only be done by Service Centers and official repair shops. Failure to do so shall void any warranty, stated or implied. Any operation expressly prohibited in this manual, any adjustments or assembly procedures not recommended or authorized in this manual shall void the warranty.

Federal Communications Commission Notice

This equipment has been tested and found to comply with the limits for a Class B Digital device, pursuant to part 15 of the FCC Rules. These limits are designed to provide reasonable protection against harmful interference in a residential installation. This equipment generates, uses and can radiate radio frequency energy and, if not installed and used in accordance with the instructions, may cause harmful interference to radio communications. However, there is no guarantee that interference will not occur in a particular installation. If this equipment does cause harmful interference to radio or television reception, which can be determined by turning the equipment off and on, the user is encouraged to try to correct the interference by one or more of the following measures:

- Reorient or relocate the receiving antenna.
- Increase the separation between the equipment and the receiver.
- Connect the equipment into an outlet on a circuit different from that to which the receiver is connected.
- Consult the dealer or an experienced radio or television technician for help.

Declaration of Conformity

Trade Name : PHILIPS
Responsible Party : P&F USA, Inc.
Model : 32PFL4901
Address : PO Box 2248, Alpharetta, GA
30023-2248 U.S.A.
Telephone Number : 1 866 813 3283

Modifications

This apparatus may generate or use radio frequency energy. Changes or Modifications to this apparatus may cause harmful interference.

Any Modifications to the apparatus must be Approved by P&F USA.

The user could lose the authority to operate this apparatus if an unauthorized Change or Modification is made.

Cables

Connections to this device must be made with shielded cables with metallic RFI / EMI connector hoods to maintain compliance with FCC Rules and Regulations.

Canadian notice

CAN ICES-3 (B)/NMB-3 (B)

Analog and Digital Television Receiving Apparatus,

Canada BETS-7 / NTMR-7.

The following FCC/IC RSS is description of Wireless LAN adapter.

FCC Caution: Any changes or modifications not expressly approved by the party responsible for compliance could void the user's authority to operate this equipment.

This transmitter must not be co-located or operating in conjunction with any other antenna or transmitter.

Country Code Statement

For product available in the USA market, only channel 11 ~ 13 can be operated. Selection of other channels is not possible.

To maintain compliance with FCC RF exposure requirements, use only belt-clips, holsters or similar accessories that do not contain metallic components in its assembly. The use of accessories that do not satisfy these requirements may not comply with FCC RF exposure requirements and should be avoided.

This device complies with Industry Canada license-exempt RSS standard(s). Operation is subject to the following two conditions: (1) this device may not cause interference and (2) this device must accept any interference, including interference that may cause undesired operation of the device.

Copyright

All other registered and unregistered trademarks are the property of their respective owners.



The terms HDMI and HDMI High-Definition Multimedia Interface, and the HDMI Logo are trademarks or registered trademarks of HDMI Licensing LLC in the United States and other countries.



Manufactured under license from Dolby Laboratories. Dolby and the double-D symbol are trademarks of Dolby Laboratories.



Sonic Emotion and the Sonic Emotion logo symbol are registered trademarks of sonic emotion ag.



ENERGY STAR® is a joint program of the U.S. Environmental Protection Agency and the U.S. Department of Energy helping us all save money and protect the environment through energy efficient products and practices.

Consumer Notice:

This TV has been set to maximize energy efficiency while delivering the best possible picture using the factory installed home mode settings.

Changing or enabling other features in this TV (e.g. brightened backlighting) will possibly increase energy consumption beyond the original ENERGY STAR® qualified limits.



Netflix is available in certain countries. Streaming membership required. More information at www.netflix.com.



VUDU™ is a trademark of VUDU, Inc.



YouTube and the YouTube logo are trademarks of Google Inc.



PANDORA, the PANDORA logo, and the Pandora trade dress are trademarks or registered trademarks of Pandora Media, Inc. Used with permission.



CinemaNow and the CinemaNow logo are trademarks of BestBuy Stores L.P. and BestBuy Canada LTD.



Hotlist, Samba, Samba TV and associated logos are trademarks of Free Stream Media Corp.

Portions of this software are copyright © The FreeType Project (www.freetype.org).

The American Academy of Pediatrics discourages television viewing for children younger than two years of age.

Some features may require an always-on broadband internet connection, firmware update and/or a minimum bandwidth. Internet services vary by location.

Third party internet services are not provided by P&F USA/Mexicana nor Philips, and may change or be discontinued at any time and may be subject to third party restrictions. Neither P&F USA/Mexicana nor Philips makes any representations or warranties about these services, which may require the creation of a user account through a computer with internet access and one-time and/or recurring charges.

2 Important

Positioning the TV

- Large screen TVs are heavy, 2 people are required to carry and handle a large screen TV.
- Make sure to hold the upper and bottom frames of the Unit firmly as illustrated.
- Install the Unit in a horizontal and stable position.
- Do not install the Unit in direct sunlight or in a place subject to dust or strong vibration.
- Depending on the environment, the temperature of this Unit may increase slightly. This is not a malfunction.
- Avoid a place with drastic temperature changes.
- Do not place anything directly on top or bottom of the Unit.
- Depending on your external devices, noise or disturbance of the picture and / or sound may be generated if the Unit is placed too close to them. In this case, please ensure enough space between the external devices and the Unit.
- Do not insert the AC power cord into the power socket outlet before all the connections are made.
- Ensure that you always have easy access to the AC Power Cord and Outlet to disconnect the TV from the AC Outlet.
- Before you move the TV, disconnect attached Cables to prevent damage to Connectors, especially the TV Tuner.
- Be sure to Unplug the AC Power Plug from the AC outlet before moving or carrying the Unit.
- When moving the TV and then Setting it down, please be careful not to pinch the AC Power Cord under the Unit.

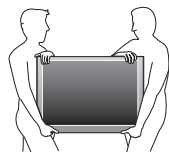

Regulatory Notices

Do not place the Unit on the furniture that is capable of being tilted by a child and an adult leaning, pulling, standing or climbing on it. A falling Unit can cause serious injury or even death.

This apparatus should not be placed in a built-in installation such as a bookcase or rack unless proper ventilation is provided. Make sure to leave a space of 4 inches (10cm) or more around this apparatus.

Press **⏻** to turn the Unit On and go into Standby mode.

To completely turn Off the Unit, you must unplug the AC power Plug from the AC Power Outlet.

Disconnect the AC Power Plug to shut the Unit Off when trouble is found or not in use. The AC Plug shall remain readily available.

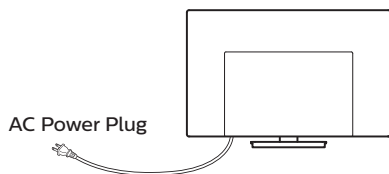

Never use a gas duster on this TV. The gas trapped inside of this Unit may cause ignition and explosion.

CAUTION: Danger of explosion if battery is incorrectly replaced. Replace only with the same or equivalent type.

WARNING: Batteries (battery pack or battery installed) shall not be exposed to excessive heat such as sunshine, fire or the like.

WARNING: To prevent injury, this apparatus must be securely attached to the furniture / wall in accordance with the instructions. Tipping, shaking or rocking the unit may cause injury / death.

Environmental Care



The packaging of this product is intended to be recycled. Contact your local authorities for information about how to recycle the packaging.

For product recycling information, please visit - www.recycle.philips.com

End of Life Directives

Philips pays a lot of attention to produce environmental-friendly products in green focal areas. Your new TV contains materials which can be recycled and reused. At the end of its life, specialized companies can dismantle the discarded TV to concentrate the reusable materials and to minimize the amount of materials to be disposed of. Please ensure you dispose of your old TV according to local regulations.

Disposal of Used Batteries

The Batteries supplied do not contain the heavy metals mercury and cadmium. Nevertheless, in many areas Batteries may not be disposed of with your household waste. Please ensure you dispose of Batteries according to local Regulations.

Downloading an Electronic Copy

To obtain a more detailed electronic copy of this manual :

- 1 Point your browser to : www.philips.com/support
- 2 Choose your country of location with language.
- 3 Enter the product name or number in the search field. Alternatively, you can browse the catalog.
- 4 Click the Description or Model.
- 5 Under Product support, click "User manual".

Preparing to Move/Ship the Unit

Please pack the Unit properly by following the Diagram on the Carton (as noted below).

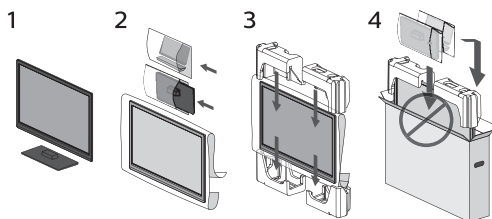

- To avoid damage to the Screen, do not pack the Stand on the same side as the TV screen, refer to the step 4 above.

Contents

1 Notice	4
2 Important	6
Positioning the TV	6
Regulatory Notices	6
Environmental Care	6
Downloading an Electronic Copy	6
Preparing to Move/Ship the Unit	6
3 Getting Started	7
Connecting Antenna or Cable / Satellite / IPTV Set-top Box	7
4 Use your TV	8
Watching Channels from an External Device	8
Displaying Setup using Home Menu	8
Network	8
Home network	9
Net TV	9
Changing Picture and Sound Settings	10
Changing Picture Format	11
Caption Settings	12
Child and Ratings Lock	12
Channel Lock	13
Setting your Location to Home	13
Viewing Photos, Playing Music and Watching Videos on a USB Memory Stick	14
5 Install Channels	14
Reinstall Channels	14
6 Troubleshooting Tips	15
7 Specifications	16
8 Warranty	17
License	end of book

3 Getting Started

Connecting Antenna or Cable / Satellite / IPTV Set-top Box

Be sure your Antenna or another Device is connected properly before plugging in the AC Power Cord.

If connecting to an Antenna through an RF cable

Any DTV Programs that are Broadcast in your area can be received for free through an Antenna Connection.

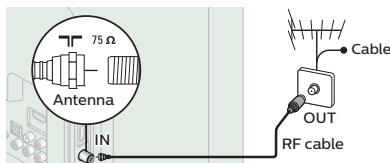

If connecting a Set-top Box through an HDMI cable

If the TV is connected to a Cable / Satellite Set-top Box via an HDMI cable, make sure you select the correct Source by using **SOURCE**.

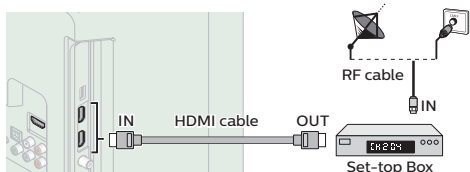

Note(s)

- It is recommended to use an HDMI-certified High-Speed HDMI® cable. If you do not use an HDMI-certified cable, you might have display issues as a result of connection errors.

Connecting a Cable / Satellite / IPTV Set-top Box, Blu-ray Disc / DVD Recorder via Composite Connectors and Analog Audio

Do Not place your Recorder too close to the Screen, because some Recorders can be susceptible to harmful interference from the TV.

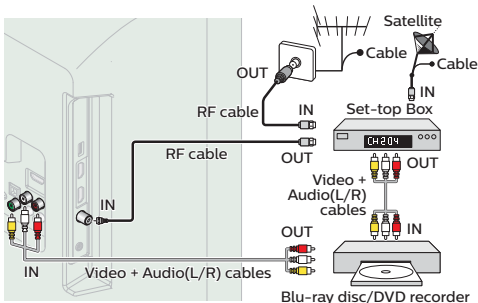

Note(s)

- If there is No Input Signal and No Operation for 15 minutes, the Unit will go into Standby mode Automatically.

4 Use your TV

Watching Channels from an External Device

- 1 Turn On the Set-top Box or the Connected Device.
 - The picture from the Set-top Box or the Connected Device might appear Automatically on the TV screen.

If the picture does not appear



- 2 Press **SOURCE** and use **◀▶** to Select the Set-top Box or the Connected Device, then press **OK**.
- 3 Use the Remote Control for the Set-top Box or the Connected Device to Select Channels to view.

Displaying Setup using Home Menu



- 1 Press **Home** to display Home Menu.

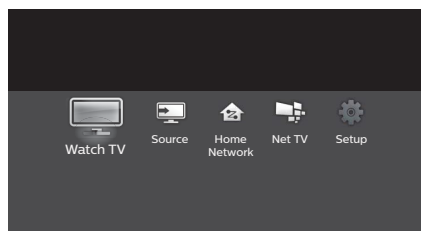

- 2 Use **◀▶** to Select **Setup**, then press **OK**.

Guide to Home Menu screen

Home Menu start screen

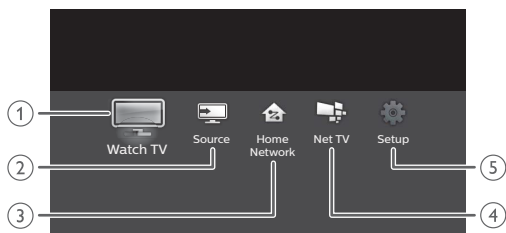

- 1 **Watch TV** : Switches back to the TV Source if another Source is selected.
- 2 **Source** : To Select Connected devices.
- 3 **Home Network** : Accesses Home Network Menus.
- 4 **Net TV** : Accesses Net TV Menus.
- 5 **Setup** : Accesses Menus that allow you to change Picture, Sound and other TV Settings.

- Please read the detailed version of this user manual on www.philips.com/support for more information on menu features.

Network

Setup Network Connection Settings in order to use Net TV or Network Upgrade functions.

- 1 Display **Setup** using Home Menu and use **▲▼◀▶** to Select **Connect to network**, then press **OK**.

Connect to Network

Before you proceed to **Connection test** or other settings in **Network** section, run the Network settings assistant to connect the TV to your Network.

Wireless Setting

Select to use a wireless LAN to connect to the Internet by a wireless connection.

- 2 Use **▲▼** to Select **Wireless**, then press **OK**.
- 3 Use **◀▶** to Select the desired Setting, then press **OK**, and follow the On-screen Instructions.

Setting items	Description
Easy Connect	Select this Setting if your router has an easy connect feature. On your router, press the easy connect button. If Connection Test fails, refer to the Router's Manual for more details.
Scan	Search for Wireless Networks automatically and select the Wireless Network name (SSID) from the list.
Manual entry	Set up the connection to the Wireless LAN Access Point (AP) (e.g. Wireless Router) manually by entering the Wireless Network name (SSID).

Wired Setting

Select to use an Ethernet Cable to connect to the Internet by a Wired Connection. Please purchase Shielded Ethernet Cables at your local store and use it when you Connect to Network equipment.

- 2 Use **▲▼** to Select **Wired**, then press **OK**
 - **Connection test** will start automatically. (Refer to **Connection Test** ➔ p. 8)

Connection Test

Perform the following steps to Test your Internet connection after you have connected an Ethernet Cable or entered Network Settings such as IP Address, DNS Settings, etc. manually.

- 1 Display **Setup** using Home Menu and use **▲▼◀▶** to Select **Network settings**, then press **OK**.
- 2 Use **▲▼** to Select **Connection test**, then press **OK**
 - Connection Test will start automatically and the Test result for Home Network and Internet will appear right after the Connection Test finishes.
 - **"Testing..."** is displayed while the Connection Test is in progress.

Home Network	Internet	Description
Pass	Pass	Connection Test is successfully completed.
Fail	-	Connection Test for Home Network failed. Check the Connection Settings.
Pass	Fail	Connection Test for Internet failed. Check the Connection Settings.

- If the Connection Test for Internet passes, Speed Test will Start Automatically.

3 Press **OK** to go to the list of Network Status Confirmation screen.

For Wireless Connection

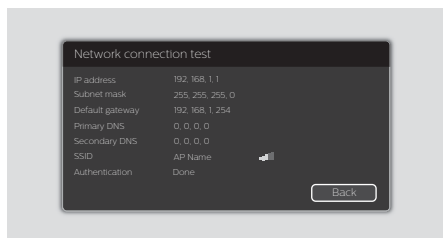

For Wired Connection

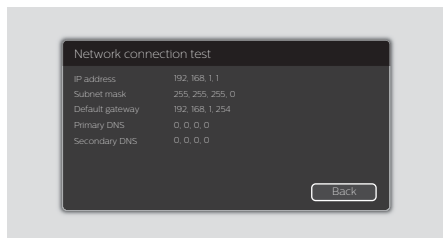

Note(s)

- If the Connection Test for both Home Network and Internet Pass, you are ready to use Net TV or Network Upgrade Functions using the Internet without making any Additional Settings.
- If the Connection Test fails, check if the Ethernet Cable is connected to this TV properly or if you have entered All the required details for the Wireless LAN Connection properly.

Home network

You can turn your TV into a Digital Media Renderer (DMR), which can play video, music and photo files stored on certified home media servers connected to your home network.

- 1 Press **▲** and use **◀▶** to Select **Setup**, then press **OK**.
- 2 Use **▲▼◀▶** to Select **Network settings**, then press **OK**.
- 3 Use **▲▼** to Select **Home network**, then press **OK**.
- 4 Use **▲▼◀▶** to Select the item you want to adjust, then press **OK**.

Renderer	Off	Disable DMR.
	On	Enable this unit to play files using DMC.
Renderer name	Change the display name of this TV to other devices on the Home Network.	

Net TV

Net TV offers Internet Services for your TV. Use the TV Remote Control to browse the Net TV pages. You can Play Movies, listen to Music and much more, all from your TV screen.

- Because Net TV is an Online System, it can be Modified over time to better serve its purpose.
- Some Net TV Services can be added, changed or stopped after some time.
- You cannot Download and Save Files or Install Plug-ins.

Before Using Net TV

Follow the procedure below before using Net TV.

- 1 Connect this Unit to the Internet.
- 2 Set up the necessary Network Connection Settings. (Refer to **Network** → p. 8.)

Using Net TV

- 1 Press **NET TV**.
 - Net TV screen will appear, then use **▲▼◀▶** to Select Service Icon.
 - For the first time only, **Terms of Use** screen will appear. After confirming the content, use **◀▶** to Select **Agree**, then press **OK**.

Guide to Net TV Menu Screen

Net TV Start Screen

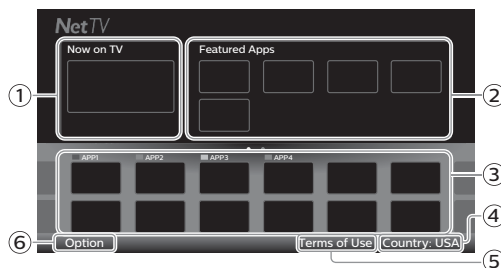

- ① **Now on TV** : Displays the image of the Input under present Tuning.
- ② **Featured Apps** : Displays fixed net service icons.
- ③ **Selected Apps** : Displays movable net service icons.
- ④ **Country** : Selects what Country you live in.
- ⑤ **Terms of Use** : Displays a copy of Net Service.
- ⑥ **Option** : Remove or move App.

Information on Network Services

For detailed Information on 3rd party Internet Services, please visit the Service Providers Website:

Netflix : <http://www.netflix.com>

VUDU : <http://www.vudu.com>

CinemaNow : <http://www.cinemanow.com>

For additional help, refer to the Frequently Asked Questions FAQs at www.philips.com/support. Select TV and enter your Model Number.

Changing Picture and Sound Settings

You must set **Home** in **Location**. ➔ p. 13

Otherwise, personalized Picture and Sound settings will not be memorized after the Unit goes into Standby Mode.

Changing Picture Settings

- 1 Press **▲** and use **◀▶** to Select **Setup**, then press **OK**.
- 2 Use **▲▼◀▶** to Select **TV settings**, then press **OK**.
- 3 Use **▲▼** to Select **Picture**, then press **OK**.

Picture	Auto picture
Sound	Backlight
Features	Contrast
Installation	Brightness
	Color
	Tint
	Sharpness
	Advanced settings
	Picture format
	Mode selection
	Auto adjustment
	Clock

- 4 Use **▲▼** to Select the item you want to adjust, then press **OK**.

Auto picture	to Select the desired Setting, then press OK (Personal, Standard, Natural, Vivid, Sports, Movie, Game, Energy saving and Internet video)	
	Cursor ▼	Cursor ▲
Backlight	to Reduce Power Consumption and Brightness	to Increase Power Consumption and Brightness
Contrast	to Decrease Contrast	to Increase Contrast
Brightness	to Decrease Brightness	to Increase Brightness
Color	to Decrease Color Intensity	to Increase Color Intensity
Tint	to Add Green	to Add Red
Sharpness	to Soften	to Sharpen
Advanced settings	to Select the desired Setting, then press OK (Color alignment, Noise reduction, Black stretch, Dynamic contrast, Gamma, Perfect Motion Rate, MPEG artifact reduction, Color enhancement, Custom color management and Film mode)	
Picture format	Automatic	Changing Picture Format ➔ p. 11
	Super zoom	
	4:3	
	Movie expand 14:9	
	Movie expand 16:9	
	Wide screen	
	Unscaled	
Mode selection	PC	to Turn Off image enhancement features which makes the TV to act purely as a monitor
	HDTV	to enable image enhancement features to improve picture quality

Auto adjustment	to adjust the Horizontal / Vertical position, Clock and Phase of the PC screen automatically	
	Cursor ▼	Cursor ▲
Clock	to Decrease setting value	to Increase setting value
Phase		
Horizontal position	to move PC screen left	to move PC screen right
Vertical position	to move PC screen down	to move PC screen up

Changing Sound Settings

- 1 Press **▲** and use **◀▶** to Select **Setup**, then press **OK**.
- 2 Use **▲▼◀▶** to Select **TV settings**, then press **OK**.
- 3 Use **▲▼** to Select **Sound**, then press **OK**.

Picture	Auto sound
Sound	Equalizer
Features	Balance
Installation	Sonic Emotion Premium
	Auto volume leveling
	TV speakers
	Headphone volume
	Digital output format
	Delta volume

- 4 Use **▲▼** to Select the item you want to adjust, then press **OK**.

- The following sound settings can be configured. Depending on the sound source, some sound settings are not available.

Auto sound	to Select the desired Setting, then press OK (Personal, Standard, Vivid, Sports, Movie, Music and News)		
Equalizer	to Select the specific Frequency using ◀▶ , and use ▲▼ to Adjust the Level, then press OK		
Balance	Adjusts the balance of the Right and Left speakers to Best suit your listening position.		
Sonic Emotion Premium	Sonic Emotion	Off	to set Sonic Emotion to Off
		On	to set Sonic Emotion to On
	Dialog Enhancement	Off	to set Dialog Enhancement to Off
		On	to set Dialog Enhancement to On
Bass Enhancement	Off	to set Bass Enhancement to Off	
	On	to set Bass Enhancement to On	
Absolute 3D Sound	Off	to set Absolute 3D Sound to Off	
	On	to set Absolute 3D Sound to On	
Auto volume leveling	Off	to Remove the Auto volume leveling	
	On	to Reduce Volume Differences between the TV Commercials and the Programs	

TV speakers	Off	No Output Sound from the Unit's Speakers
	On	to Output Sound from the Unit's Speakers
	Speakers EasyLink	to control Audio Output from your connected HDMI Link devices
Headphone volume	Adjusts headphone volume.	
Digital output format	PCM	to Output PCM format
	Bitstream	to Output Audio in its native format as Bitstream to connected Audio receiver
Delta volume	Provides the ability to set a custom volume level for the current channel or input source. If the source volume is too loud, set a negative value (-1 to -12). If the source volume is too soft, set a positive value (+1 to +12)	

Changing Picture Format

Display Modes can be Selected when your TV receives a 16:9 or 4:3 Video Signal.

Three types of Display Modes can be Selected for a PC Input Signal.

Press **FORMAT** Repeatedly to Switch the TV Aspect Ratio.

For 16:9 Video signal

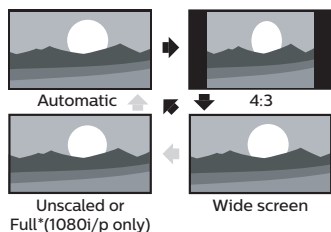

Automatic	Other than DTV and HDMI connected devices, enlarges the picture to Best fit the screen. DTV and HDMI connected devices display the picture at its original size. The subtitles may remain visible.
4:3	Displays a 16:9 picture at a 4:3 size; the picture is shortened horizontally. Sidebars appear on both edges of the screen.
Wide screen	Displays a 16:9 picture that is stretched horizontally and vertically.
Unscaled or Full* (1080i/p only)	Displays a scaled 16:9 picture. Bars appear on both the Upper and Lower portions of the screen depending on the type of video signal.

* This part differs depending on the product you have.

For 4:3 Video signal

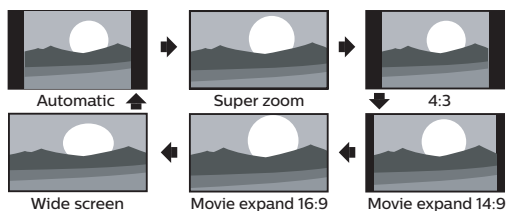

Automatic	Other than DTV and HDMI connected devices, enlarges the picture to Best fit the screen. DTV and HDMI connected devices display the picture at its original size. The subtitles may remain visible.
Super zoom	Displays a 4:3 picture at a 16:9 size; the picture is stretched horizontally and vertically and its left and right edges are enlarged. This crops out some of the top and bottom of the picture.
4:3	Displays a 4:3 picture at its original size. Sidebars appear on both edges of the screen.
Movie expand 14:9	Displays a 4:3 picture at a 14:9 size; the picture is stretched horizontally and vertically. This crops out some of the top and bottom of the picture. Sidebars appear on both edges of the screen.
Movie expand 16:9	Displays a 4:3 picture at a 16:9 size; the picture is stretched horizontally and vertically. This crops out some of the top and bottom of the picture.
Wide screen	Displays a picture that is stretched out of proportion to fill the screen.

For PC Input signal

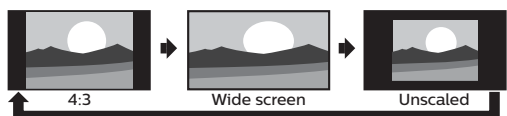

- This unit can also be connected to your PC that has a DVI Terminal. Use an HDMI-DVI Conversion Cable for this Video Connection and it requires Stereo Mini 3.5mm Plug Audio Cable for Analog Audio signal as well.
- Refer to 16:9 Video Signal on this page if the PC has HDMI Output.

4:3	Displays a proportionately stretched picture. Sidebars appear on both edges of the screen.
Wide screen	Displays a picture that is stretched out of proportion to fill the screen.
Unscaled	Displays a picture in its original size.

If the signal source has side or top-bottom bars inserted into the picture, the Picture Format function will not eliminate them.

Caption Settings

Closed Captions displays the Audio portion of the Program as Superimposed Text over the Video.

- 1 Press **▲** and use **◀▶** to Select **Setup**, then press **OK**.
- 2 Use **▲▼◀▶** to Select **TV settings**, then press **OK**.
- 3 Use **▲▼** to Select **Features**, then press **OK**.
- 4 Use **▲▼** to Select **Caption settings**, then press **OK**.

Closed Captions

You can choose the Closed Caption display.

- 5 Use **▲▼** to Select **Closed captions**, then press **OK**.
- 6 Use **▲▼** to Select **On, Off** or **CC w/ mute**, then press **OK**.

Cable / NTSC (Analog) TV Operation

Caption service

- 5 Use **▲▼** to Select **Caption service**, then press **OK**.
- 6 Use **▲▼** to Select the desired **Caption service**, then press **OK**.

CC-1 and T-1	The primary Closed Captions and Text Services. The Closed Captions or Text is Displayed in the same Language as the Program's Dialog (up to 4 lines of script on the TV Screen).	
CC-3 and T-3	Serve as the preferred Data Channels. The Closed Captions or Text is often a Secondary Language.	
CC-2, CC-4, T-2 and T-4	Rarely available and Broadcasters use them only in Special conditions, such as when CC-1 and CC-3 or T-1 and T-3 are Not available. • There are 3 Display modes according to Programs:	
	Paint-on	Displays Characters on the TV screen immediately.
	Pop-on	Once Characters are Stored in Memory, they are Displayed All at Once.
	Roll-up	Displays the Characters Continuously by Scrolling (max. 4 lines).

Digital TV Operation

Digital Caption service

- 5 Use **▲▼** to Select **Digital caption service**, then press **OK**.
- 6 Use **▲▼** to Select the desired **Digital caption service**, then press **OK**.

CS-1 to CS-6	Select one of these before changing any other item in Caption settings menu. Choose CS-1 under normal conditions.
--------------	---

Digital caption options

You can choose the Size, Font, Color, Background and other characteristics for the Captioned Text.

- 5 Use **▲▼** to Select **Digital caption options**, then press **OK**.
- 6 Use **▲▼** to Select an item and press **OK**, then use **▲▼** to Select the desired Setting and press **OK**.

Note(s)

- Closed Captions Service may not be controlled by this Unit's Menu options if you are watching television through a Set-top Box. In which case you will need to use the Menu options on the External Set-top Box to control Closed Captions.
- The Captions do not always use correct Spelling and Grammar.
Not all TV Programs and product Commercials include Closed Captions information. Refer to your area TV Program Listings for the TV Channels and times of Closed Captions shows. The Closed Captions Programs are usually noted in the TV Listings with a Service Mark such as **CC**.
- Not all Closed Captions Services are used by a TV Broadcaster during the Transmission of a Closed Caption Program.
- The EUT (Equipment Under Test) setting that satisfies § 79.102 (e) is as follows:
 - Font: Mono-font
 - Character Size: Large

Child and Ratings Lock

You can prevent your children from watching certain Programs or certain Channels by locking the TV Controls and by using Ratings.

- 1 Press **▲** and use **◀▶** to Select **Setup**, then press **OK**.
- 2 Use **▲▼◀▶** to Select **Channel settings**, then press **OK**.
- 3 Use **▲▼** to Select **Child lock**, then press **OK**.
- 4 Use the **NUMBER** buttons to enter the 4-digit numbers for your PIN code.
 - When you have not set up your PIN code, enter **0, 0, 0, 0**.
 - When the PIN code is correct, **Child lock** menu is displayed.

Setting TV and Movie Ratings

TV Ratings Lock has Controlled Access to Individual Programs based on their Age and Content rating. Movie Ratings Lock is the Rating System created by MPA.

- 5 Use **▲▼** to Select **TV ratings lock** or **Movie ratings lock**, then press **OK**.
- 6 Use **▲▼** to Select the Desired Rating, then press **OK** Repeatedly to Switch between Block and View.
 - For US TV Ratings, you can further set the Sub Ratings to Block Specific Elements within Programs.
 - or indicates that the Rating is Locked.
 - indicates that the Rating is Not Locked (Viewable).

Movie ratings	TV ratings	Description
All		All Ratings Locked including No Rating
NR	None	No Rating
-	TV-Y	Appropriate for All Children
-	TV-Y7	Appropriate for All Children 7 and Older
G	TV-G	General Audience
PG	TV-PG	Parental Guidance Suggested
PG-13	-	Unsuitable for children under 13
-	TV-14	Unsuitable for children under 14
R	-	Restricted under 17 Requires Accompanying Parent or Adult Guardian
NC-17	-	No One under 17 Admitted
X	TV-MA	Mature Audience Only

Canadian English or Canadian French Ratings

You can select the Rating for Canadian English or Canadian French broadcasting.

- 5 Use ▲▼ to Select **Canadian English rating** or **Canadian French rating**, then press **OK**.
- 6 Use ▲▼ to Select the Desired Rating, then press **OK** Repeatedly to Switch between Block and View.
 - ✖ Indicates that the Rating is Locked (Blocked).
 - □ Indicates that the Rating is Not Locked (Viewable).

Canadian English rating	Canadian French rating	Description
All		Locked All Ratings
E		Exempt Program
C	–	For All Children
C8+	–	For All Children 8 and Older
G		General Audience
–	8 ans+	Unsuitable for Ages under 8
PG	–	Parental Guidance Suggested
–	13 ans+	Unsuitable for Ages under 13
14+	–	Unsuitable for Ages under 14
–	16 ans+	Unsuitable for Ages under 16
18+	18 ans+	Adult Audience Only

Note(s)

- The V-Chip can Block Non Rated Programs as per "CEA-608-E sec. L.3". If the Option to Block **NR, None** or **E** Programs are used in **Movie ratings lock, TV ratings lock, Canadian English rating** or **Canadian French rating** accordingly "unusual results may occur and the Unit may not Receive Emergency Bulletins or other Types of Programming" / Emergency Bulletins (Such as EAS messages, Weather Warnings and Others) / Locally originated Programming / News / Political / Public Service Announcements / Religious / Sports / Weather.

Channel Lock

Set it to Restrict Access on Particular Channels.

- 1 Press **OK** while viewing a TV program.
 - Channel list will be displayed.
- 2 Use ▲▼◀▶ to Select a Channel, then press **red** key.
- 3 Use the **NUMBER** buttons to enter the 4-digit Numbers for your Child Lock Code.
 - The Channel will be marked with Icon.
 - To Unlock Channels, select a Channel to Unlock at step 2.

Set it to Restrict Access on External inputs.

- 1 Press **SOURCE** and use ◀▶ to Select an Input.
- 2 Press **OPTIONS** and use ▲▼ to Select Lock or Unlock, then press **OK**.
- 3 Use the **NUMBER** buttons to enter the 4-digit Numbers for your Child Lock Code.

Setting your Location to Home

You can set the **Location** on your TV to **Home** or **Retail**. Choosing **Home** gives you full flexibility to change predefined settings for Picture and Sound.

- 1 Press **Home** and use ◀▶ to Select **Setup**, then press **OK**.
- 2 Use ▲▼◀▶ to Select **TV settings**, then press **OK**.
- 3 Use ▲▼ to Select **Installation**, then press **OK**.

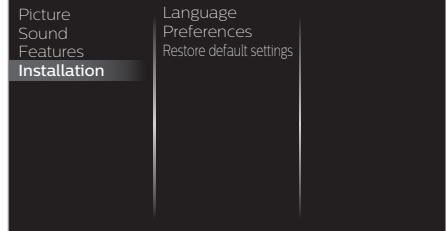

- 4 Use ▲▼ to Select **Preferences**, then press **OK**.
- 5 Use ▲▼ to Select **Location**, then press **OK**.
- 6 Use ▲▼ to Select **Home**, then press **OK**.

Note(s)

- You must set **Home** in the Menu. Otherwise, personalized Picture and Sound Settings will Not Be Memorized after the Unit goes into Standby Mode.

Viewing Photos, Playing Music and Watching Videos on a USB Memory Stick

Your TV is fitted with a USB connection that enables you to view Photos, listen to Music or watch Video files stored on a USB Memory Stick.

- 1 Press **SOURCE** and use **◀▶** to Select **USB**, then press **OK**.
- 2 Use **▲▼◀▶** to Select the desired File, then press **OK**.

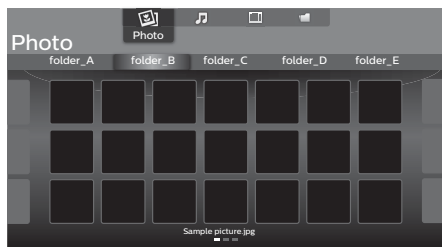

- These Recorded Files must meet Specifications shown below:

Picture (JPEG / Progressive JPEG)		
JPEG	Upper limit	4000x4000 pixels
Progressive JPEG	Upper limit	1024x768 pixels

Music (MP3 / WAV / AAC)		
MP3	Sampling frequency	16 kHz - 48 kHz
	Constant bit rate	8 kbps - 320 kbps
WAV	Sampling frequency	8 kHz - 48 kHz
	Constant bit rate	64 kbps - 1.5 Mbps
AAC	Sampling frequency	8 kHz - 48 kHz
	Constant bit rate	-

Video (MPEG / VOB / AVI / MP4)						
Maximum Video	H.264, H.265/HEVC, MPEG: 1920x1080@60fps					
Extension	.avi	.mpg, .mpeg	.ts, .trp, .tp	.vob	.mp4	.mkv
Video codec	MPEG1, MPEG2, MPEG4, H.264	MPEG1, MPEG2, MPEG4	MPEG1, MPEG2, H.264, H.265/HEVC	MPEG1, MPEG2	MPEG1, MPEG2, MPEG4, H.264, H.265/HEVC	MPEG1, MPEG2, MPEG4, H.264, H.265/HEVC
Audio codec						
Dolby Digital	YES	YES	YES	YES	YES	YES
MPEG1/2 audio layer1/2/3	YES	YES	YES	YES	NO	YES
LPCM	YES	YES	YES	YES	YES	YES
AAC-LC	YES	YES	YES	YES	YES	YES

Note(s)

- This unit accepts USB Memory Stick only. Other storage devices such as external HDD by USB Bus Power will not work.
- Do not use an Extension Cord and/or USB Hub to connect devices to this Unit. Always Directly insert the USB Flash Memory Stick to this Unit directly.
- We cannot be held responsible if your USB Memory Stick is Not Supported, nor will we accept any liability for damage or loss of stored data.
- The USB Memory Stick is Not Supplied with this TV.
- A maximum of 1,023 folders or files can be recognized.
- A File Name exceeding 256 characters or contains a Dot character is Not Supported on this TV.
- A USB Memory Stick that required its own driver or the device with a special system such as fingerprint recognition are not supported.
- Be sure to keep a Backup Copy of the Original files on your USB device before you Play them back on this Unit. We have no responsibilities for damage or loss of your USB Stored Data.
- To avoid damaging the USB Memory Stick and the Unit always Turn Off the Unit before you remove the USB Memory Stick.
- This Unit is not allowed to use the USB Memory Stick which requires external power supply (500 mA or more).
- This Unit does not support MTP (Media Transfer Protocol) or the file other than FAT16 and FAT32 file system. If the file is not supported, an error message appears.
- When the Unit does not recognize the USB Memory Stick, try reconnecting it.
- Playing the files recorded with high bit rates, the images can be interrupted in some occasions.
- This Unit does not support external subtitles.
- This Unit cannot play back a file which goes over the limit of File Restriction Limit.

5 Install Channels

Reinstall Channels

Be sure the RF cable is correctly connected to this Unit and you are registered with your Cable TV provider when you Install Cable channels.

- 1 Press **HOME** and use **◀▶** to Select **Setup**, then press **OK**.
- 2 Use **▲▼◀▶** to Select **Search for channels**, then press **OK**.
- 3 Use **◀▶** to Select **Start**, then press **OK**.
- 4 Use **▲▼** to Select **Antenna** or **Cable**, then press **OK**.
- 5 Select **Start**, then press **OK**.
 - Channel search will start automatically.

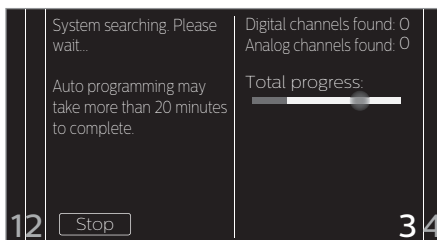

- 6 Press **OK** on **Finish** to complete.

6 Troubleshooting Tips

If the Unit does Not Perform Properly when Operated as Instructed in this Manual,

Please check the following Troubleshooting Tips and All Connections Once before calling for Service.

Power

No Power

- Make sure that the AC outlet supplies the proper voltage, plug another electrical appliance into the AC outlet to ensure that the AC outlet operates normally.
- If a Power Failure occurs, unplug the AC Power Cord for 1 minute to allow the Unit to Reset itself.

Remote

Remote Control Buttons or Remote itself does Not Work.

- Re-insert or replace the AAA Batteries with their Polarities (+/-) as indicated on the Remote Control Battery area.
- When there is an Infrared-equipped device near this Unit, it may interrupt the Remote Control Signal from this Unit.
- Make sure that Nothing is Blocking the Unit's Remote Control Sensor and the Remote Control is Pointed at this Remote Control Sensor.
- Press and Hold any Key on Remote Control toward a Digital or Cell Phone Camera. The Remote Control is working if you confirm a Flashing Infrared Light through the Camera. Some Dual Camera Cell Phones may have an IR Filter in one or both of the Cell Phone Cameras.

Universal Remote Control does not work properly.

- Refer to the User Manual of the Universal Remote Control for the Philips code.

Picture

Power is On but No Screen Image.

- Check whether the Connection for the Antenna, Cable or Set-top Box is Connected Correctly.
- Check whether All the Cables to the Unit are connected to the correct Output Jack on your separate Device like Blu-ray Disc / DVD Recorder.
- Check if your computer is NOT in Sleep Mode when the Input Mode on this Unit is in PC mode. Tap any Key on the Computer Keyboard to Wake it up.
- Check if the correct Input Mode is selected by pressing

SOURCE

No Color

- Adjust **Color** in **Picture** settings. **→ p. 10**

Picture Poor, Sound OK

- Electrical Interference from nearby appliances may affect Picture Quality.
- Adjust **Contrast** and **Brightness** in **Picture** Settings. **→ p. 10**
- For the Best Picture Quality, watch "High Definition" wide screen Programs. If the HD content is Not available, watch "Standard Definition" Programs instead.

You see Noise or Trash on the Screen.

- When the capabilities on the Unit exceed the capabilities of the Digital Broadcasting, the signal will be increased to match the capabilities of the Display on the Unit. This may cause Noise or Trash.

Unusual picture appears and the TV does Not Operate.

- Press the Power button first. If it does not solve, follow the procedure below.

- 1 Press the buttons on the Remote Control in the order shown below.



- 2 Unplug the AC Power Cord, then wait for 1 minute, and then plug it in again.

Picture & Sound

No Picture or Sound

- View other TV channels. The problem might be limited to the Broadcasting Station or Weak Signal Strength.
- Unplug the AC Power Cord and wait for about 1 minute, then Plug the AC Power Cord and turn On the Unit again.
- Autoprogram must be completed when you Set Up the Unit for the First time or Move it to a location where previously unavailable channels are broadcast.
- The selected Channel cannot be viewed by the **Child and Ratings Lock** Setting. **→ p. 12**
- The Unit requires some kind of Input Signal. A Digital Indoor Antenna (VHF / UHF), a Digital External Antenna (VHF / UHF) or an RF coaxial cable from your Wall or Set-top Box signal (HDMI, Component+Audio or Composite [Video+Audio]) needs to be connected to the Unit.

Adjusted Picture or Sound settings are not effective every time the Unit is turned On.

- You must set to **Home** in **Location**. **→ p. 13** (Otherwise, the Settings you adjusted will not be memorized after the Unit goes into Standby Mode.)

You see a Distorted Picture or Hear an Unusual Sound.

- You may be getting NTSC (Analog) TV signal (not HDTV signal) interference from electrical appliances, automobiles, motorcycles or fluorescent lights.
- Try moving the Unit to another Location to see if this is the Cause of the Problem.

Sound

No Sound, Distorted Sound or Incorrect Audio Sound is heard when using the HDMI-DVI connections.

- Make sure that the Analog Audio signals from the HDMI-DVI device are connected to the Analog Audio Input L/R jacks.

Sound Poor, Picture OK

- Check if the Audio Cable is connected into the Unit correctly.

You Switch to a Different Input and the Volume Changes.

- This Unit will Memorize the Volume Level from the last time you adjusted it.
- If the Volume of the Sound from another Device is Higher or Lower, then the Loudness will Change.

Child and Rating Lock

Forgotten PIN code.

- Enter "07 11" to clear your password.

Screen

You Switch to a different Input and the Screen Size changes.

- This Unit will Memorize the Viewing Mode from the last time you used those Particular Input Modes.

The Display image does not cover the Entire Screen.

- If you are using the unit as a PC monitor, make sure that **Horizontal position** and **Vertical position** in PC settings are set correctly.
- If you are watching TV or using the Composite Video, Component Video or HDMI with 480i Input, press **FORMAT** Repeatedly to Switch to various Screen Modes.

Closed Captions

Closed Captions are displayed as a white box. No Closed Captions are displayed in the Closed Captions-Supported Program.

- Interference from buildings or weather conditions may cause Closed Captions to be incomplete if watching Analog TV signals.
- Broadcasting Station may shorten the program to insert advertisements.
- The Closed Captions Decoder cannot read the information of a shortened program.
- Closed Captions that are delayed a few seconds behind the actual dialog are common for Live broadcasts. Most captioning production companies can display a dialog to maximum of 220 words per minute. If a dialog exceeds that rate, selective editing is used to insure that the Closed Captions remain up-to date with the current TV screen dialog.

Black Box is displayed on the TV Screen.

- The Text mode is selected. For Closed Captions, select **CC-1**, **CC-2**, **CC-3** or **CC-4**.

Network

Cannot connect to the Network.

- Check if the Ethernet Cable connection is properly made. Turn On the Broadband Router and/or Modem.
- Check the Network Settings.
- Check if the Broadband Router and/or Modem is correctly connected.



Note(s)

- The LCD screen is manufactured to provide many years of useful life. Occasionally a few non active pixels may appear as a fixed point of blue, green or red. This is Not to be considered a Defect in the LCD screen.
- Some Functions are not available in Specific Modes, but this is Not a Malfunction. Read the Description in this Manual for more Details on Correct Operations.

For additional troubleshooting, refer to the Frequently Asked Questions or FAQs on www.philips.com/support.

7 Specifications

Model #		32PFL4901
Picture		
Type	WXGA (1366 x 768 pixels 60Hz)	
Diagonal screen size / Aspect ratio	31.5" / 16:9	
Viewing Angles	176° (V) by 176° (H)	
Built-in Digital / Analog Tuner	ATSC (Digital) / NTSC (Analog)	
Sound		
Mono / Stereo	Mono, Stereo, Sonic Emotion Premium	
Power Output (RMS watts)	8W x 2	
Equalizer	5 Band	
Ease of Use		
Picture Format	SD (4:3 Source)	: Automatic / Super zoom / 4:3 / Movie expand 14:9 / Movie expand 16:9 / Wide screen
	HD (16:9 Source)	: Automatic / 4:3 / Wide screen / Unscaled or Full
Photo Slide Show	JPEG, Progressive JPEG	
Music Playback	MP3, WAV, AAC	
Video Playback	MPEG1, MPEG2, H.264, MPEG4, H.265/HEVC	
Channel		
Channel Coverage	Over-the-Air DTV (ATSC)	: VHF: 2-13 UHF: 14-69 (Each Channel may have e.g. 2.1-2.9, 3.1-3.9, etc)
	Over-the-Air Analog (NTSC)	: VHF: 2-13 UHF: 14-69
CATV (Analog NTSC)	2-13, A-W W+1-W+94 (Analog W+1-W+84), A-5-A-1, 5A	
Tuning System	Channel Frequency Synthesized Tuning System	
Channel Access	Direct Access Number Keyboard, Programmable Scan, Channel +(up) / -(down) and PREV. CH (Previous Channel)	
Connectivity		
Component Video Input (Y/Pb/Pr)	1 Supporting Video Signals : 480i/p, 720p, 1080i/p @60Hz	
Composite Video Input (Shared Y Green Terminal with Component Video)	1	
HDMI Input	3	
	Supporting HDMI Video Signals : 480i/p, 720p, 1080i @60Hz, 1080p @24/30/60Hz	
	Supporting HDMI Digital Audio Signals : LPCM, AC3, DD+ Supporting PC-Input Video Signal up to FHD (1920 x 1080)	
Analog Audio L/R Input	1 (L Audio / R Audio)	
PC Input	Via VGA, HDMI and HDMI-DVI + Analog Audio L/R	
USB	1	
Wireless LAN	Supporting wireless standards : IEEE 802.11a/b/g/n/ac (2.4GHz)	
Ethernet port	1	
Digital Audio Output	1	
	Supporting Dolby Digital and Dolby Digital Plus	
Headphone Output	1 1/8 inch (3.5mm)	
Power		
Power Requirements	120V ~ +/- 10%, 60Hz +/- 0.5%	
Temperature		
Operating Temperature	41 °F (5 °C) to 104 °F (40 °C)	

· Specifications are Subject to Change without Prior Notice.

8 Warranty

PHILIPS LIMITED WARRANTY ONE (1) YEAR

WARRANTY COVERAGE:

PHILIPS warranty obligation is limited to the terms set forth below.

WHO IS COVERED:

Philips warrants the product to the original purchaser or the person receiving the product as a gift against defects in materials and workmanship as based on the date of original purchase ("Warranty Period") from an Authorized Dealer. The original sales receipt showing the product name and the purchase date from an authorized retailer is considered such proof.

WHAT IS COVERED:

The Philips warranty covers new products if a defect in material or workmanship occurs and a valid claim is received by Philips within the Warranty Period. At its option, Philips will either (1) repair the product at no charge, using new or refurbished replacement parts, or (2) exchange the product with a product that is new or which has been manufactured from new, or serviceable used parts and is at least functionally equivalent or most comparable to the original product in Philips current inventory, or (3) refund the original purchase price of the product.

Philips warrants replacement products or parts provided under this warranty against defects in materials and workmanship from the date of the replacement or repair for ninety (90) days or for the remaining portion of the original product's warranty, whichever provides longer coverage for you. When a product or part is exchanged, any replacement item becomes your property and the replaced item becomes Philips' property. When a refund is given, your product becomes Philips' property.

Note: Any product sold and identified as refurbished or renewed carries a ninety (90) day limited warranty.

Replacement product can only be sent if all warranty requirements are met. Failure to follow all requirements can result in delay.

WHAT IS NOT COVERED - EXCLUSIONS AND LIMITATIONS:

This Limited Warranty applies only to the new products manufactured by or for Philips that can be identified by the trademark, trade name, or logo affixed to it. This Limited Warranty does not apply to any non-Philips hardware product or any software, even if packaged or sold with the product. Non-Philips manufacturers, suppliers, or publishers may provide a separate warranty for their own products packaged with the bundled product.

Philips is not liable for any damage to or loss of any programs, data, or other information stored on any media contained within the product, or any non-Philips product or part not covered by this warranty. Recovery or reinstallation of programs, data or other information is not covered under this Limited Warranty.

This warranty does not apply (a) to damage caused by accident, abuse, misuse, neglect, misapplication, or non-Philips product, (b) to damage caused by service performed by anyone other than Philips or Philips Authorized Service Location, (c) to a product or a part that has been modified without the written permission

of Philips, or (d) if any Philips serial number has been removed or defaced, or (e) product, accessories or consumables sold "AS IS" without warranty of any kind by including refurbished Philips product sold "AS IS" by some retailers.

This Limited Warranty does not cover:

- Shipping charges to return defective product to Philips.
- Labor charges for installation or setup of the product, adjustment of customer controls on the product, and installation or repair of antenna/signal source systems outside of the product.
- Product repair and/or part replacement because of improper installation or maintenance, connections to improper voltage supply, power line surge, lightning damage, retained images or screen markings resulting from viewing fixed stationary content for extended periods, product cosmetic appearance items due to normal wear and tear, unauthorized repair or other cause not within the control of Philips.
- Damage or claims for products not being available for use, or for lost data or lost software.
- Damage from mishandled shipments or transit accidents when returning product to Philips.
- A product that requires modification or adaptation to enable it to operate in any country other than the country for which it was designed, manufactured, approved and/or authorized, or repair of products damaged by these modifications.
- A product used for commercial or institutional purposes (including but not limited to rental purposes).
- Product lost in shipment and no signature verification receipt can be provided.
- Failure to operate per Owner's Manual.

TO OBTAIN ASSISTANCE IN THE U.S.A., CANADA, PUERTO RICO, OR U.S. VIRGIN ISLANDS...

Contact Philips Customer Care Center at:
1-866-813-3283

REPAIR OR REPLACEMENT AS PROVIDED UNDER THIS WARRANTY IS THE EXCLUSIVE REMEDY FOR THE CONSUMER. PHILIPS SHALL NOT BE LIABLE FOR ANY INCIDENTAL OR CONSEQUENTIAL DAMAGES FOR BREACH OF ANY EXPRESS OR IMPLIED WARRANTY ON THIS PRODUCT. EXCEPT TO THE EXTENT PROHIBITED BY APPLICABLE LAW, ANY IMPLIED WARRANTY OF MERCHANTABILITY OR FITNESS FOR A PARTICULAR PURPOSE ON THIS PRODUCT IS LIMITED IN DURATION TO THE DURATION OF THIS WARRANTY.

Some states do not allow the exclusions or limitation of incidental or consequential damages, or allow limitations on how long an implied warranty lasts, so the above limitations or exclusions may not apply to you.

This warranty gives you specific legal rights. You may have other rights which vary from state/province to state/province.

P&F USA, Inc. PO Box 2248, Alpharetta, GA 30023-2248

License

P&F USA, Inc. hereby offers to deliver, upon request, a copy of the complete corresponding source code for the copyrighted open source code packages, on an "AS IS" basis, used in this product for which such offer is requested by the respective licenses. This offer is valid up to three years after the product purchase to anyone in receipt of this information. To obtain source code, please contact P&F USA, Inc. You should write to "Open Source Team, P&F USA, Inc., PO Box 2248, Alpharetta, GA 30023-2248. P&F USA, Inc. disclaims any and all warranties and representations with respect to such software and related source code including quality, reliability, usability, and accuracy, and further disclaim all express, implied, statutory or otherwise, including without limitation, any implied warranties of title, non-infringement, merchantability, or fitness for a particular purpose. P&F USA, Inc. shall not be liable to make any corrections to the open source software or source code or to provide any support or assistance with respect to it. P&F USA, Inc. disclaims any and all liability arising out of or in connection with the use of this software and/or source code.



P&F USA, Inc.
PO Box 2248, Alpharetta, GA 30023-2248 U.S.A.

P&F Mexicana, S.A. de C.V.
Av. La Palma No. 6, Col. San Fernando La Herradura.
Huixquilucan, Edo. de México. C.P. 52787

Philips and Philips Shield are used under license of
Koninklijke Philips N.V.

Printed in Thailand
A5DFGUT



* 2 E M N O 0 4 1 1 *