

Register your product and get support at
www.philips.com/welcome



EN User manual

42PFL9664H

47PFL9664H

PHILIPS

Contact information



België / Belgique

078 250 145 - € 0.06 / min

Danmark

3525 8759 - Lokalt opkald

Deutschland

0800 000 7520 - Kostenlos

France

0805 025 510 - gratuit

Ελλάδα

0 0800 3122 1280 - Κλήση χωρίς χρέωση

España

900 800 655 - gratuito

Italia

800 088 774 - gratuito

Ireland

01 601 1777 - Free

Northern Ireland 0800 055 6882

Luxembourg / Luxemburg

40 6661 5644 - Ortsgespräch
Appel local

Nederland

0800 023 0076 - gratis

Norge

2270 8111 - Lokalsamtale

Österreich

0810 000 205 - € 0.07 / min

Portugal

800 780 903 - gratis

Suisse / Schweiz / Svizzera

0844 800 544 - Ortsgespräch
Appel local
Chiamata locale

Sverige

08 5792 9100 - Lokalsamtal

Suomi

09 2311 3415 - paikallispuhelu

United Kingdom

0800 331 6015 - Free

Estonia

6008600 - Local

Lithuania

67228896 - Local

Latvia

527 37691 - Local

Казакстан

007 727 250 66 17 - Local

България

+3592 489 99 96 - Местен разговор

Hrvatska

01 6403 776 - Lokalni poziv

Česká republika

800 142840 - Bezplatný hovor

Polska

022 3491504 - połączenie lokalne

Type nr. _____

Product nr. _____

Magyarország

06 80018 189 Ingyenes hívás

România

0800 894 910 - gratuit

Россия

- Москва
(495) 961-1111 - Местный звонок
- 8-800-200-0880 - Местный звонок

Србија

+381 114 440 841 - Lokalni poziv

Slovakia

0800 004537 - Bezplatný hovor

Slovenija

0821 611 655 - € 0.09 / min

Türkiye

0800 261 3302 - Şehir içi arama

Україна

8-800-500-6970 - Місцевий виклик

1.1.1 Enjoy HD TV

1/2

This TV can display High Definition programmes, but to enjoy HD TV you need to get programmes in HD first. If you are not watching HD programmes, the picture quality will be that of a normal TV.

You can receive programmes in High Definition from...

- a Blu-ray Disc player, connected with an HDMI cable, with an HD Movie
- a digital HD receiver, connected with an HDMI cable, with a subscription to HD channels from a cable or satellite company
- an Over-the-air HD broadcaster (DVB-T MPEG4)
- an HD channel on your DVB-C network
- an HD Game console (Xbox 360 / PlayStation 3), connected with an HDMI cable, with an HD game.

1.1.1 Enjoy HD

2/2

Contact your dealer for more information. Go to www.philips.com/support to find FAQ's featuring the list of HD channels or providers in your country.

1.1.2 Safety

1/5

Make sure you have read and understood all instructions before using your TV. The warranty becomes invalid if any damage is caused by failure to follow instructions.

Risk of electric shock or fire!

- Never expose the TV or remote control to rain, water or excessive heat.

- Never place liquid containers, such as vases, near the TV. If liquids are spilt on or into the TV, disconnect the TV from the power outlet immediately. Contact Philips Consumer Care to have the TV checked before use.

1.1.2 Safety

2/5

- Never place the TV, remote control or batteries near naked flames or other heat sources, including direct sunlight.
- Keep candles and other naked flames away from this product at all times.
- Never insert objects into the ventilation slots or other openings on the TV.

- Ensure power plugs do not come under heavy force. Loose power plugs can cause arcing and are a fire hazard.
- Never place the TV or any objects on the power cord.
- When disconnecting the power cord, always pull the plug, never the cord.

...

1.1.2 Safety

3/5

Risk of injury or damage to the TV!

- Two people are required to lift and carry a TV that weighs more than 25 kg.
- If you mount the TV on a stand, only use the supplied stand. Secure the stand to the TV tightly. Place the TV on a flat, level surface that can support the weight of the TV.

- When mounting the TV on a wall, ensure that the wall mount can safely bear the weight of the TV set. Koninklijke Philips Electronics N.V. bears no responsibility for improper wall mounting that results in accident, injury or damage.

...

1.1.2 Safety

4/5

Risk of injury to children!

Follow these precautions to prevent the TV from toppling over and causing injury to children:

- Never place the TV on a surface covered by a cloth or other material that can be pulled away.
- Ensure that no part of the TV hangs over the edge of the mounting surface.

- Never place the TV on tall furniture, such as a bookcase, without anchoring both the furniture and TV to the wall or a suitable support.

- Educate children about the dangers of climbing on furniture to reach the TV.

...

1.1.2 Safety

5/5

Risk of overheating!

Always leave a space of at least 10cm around the TV for ventilation. Ensure curtains or other objects never cover the ventilation slots on the TV.

Lightning storms

Disconnect the TV from the power outlet and antenna before lightning storms. During lightning storms, never touch any part of the TV, power cord or antenna cable.

Risk of hearing damage!

Avoid using earphones, headphones at high volumes or for prolonged periods of time.

Low temperatures

If the TV is transported in temperatures below 5°C, unpack the TV and wait until the TV temperature matches the room temperature before connecting the TV to the mains.

1.1.3 Position the TV

Carefully read the safety precautions before positioning the TV.

- Position the TV where light does not shine directly on the screen.
- Dim lighting conditions in the room for best Ambilight effect.
- Position the TV up to 25 cm away from the wall for the best Ambilight effect.



1.1.4 Viewing distance

Position the TV at the ideal viewing distance. Benefit more from HD TV picture or any picture without straining your eyes. Find the 'sweet spot', right in front of the TV, for the best possible TV experience and relaxed viewing.

The ideal distance to watch TV from is three times its diagonal screen size. While seated, your eyes should be level with the centre of the screen.

1.1.5 Screen care

- Risk of damage to the TV screen! Never touch, push, rub or strike the screen with any object.
- Unplug the TV before cleaning.
- Clean the TV and frame with a soft damp cloth. Never use substances such as alcohol, chemicals or household cleaners on the TV.
- To avoid deformations and colour fading, wipe off water drops as soon as possible.
- Avoid stationary images as much as possible. Stationary images are images that remain onscreen for extended periods of time. Stationary images include onscreen menus, black bars, time displays, etc. If you must use stationary images, reduce screen contrast and brightness to avoid screen damage.

1.1.6 End of use

1/4

Disposal of your old product and batteries

Your product is designed and manufactured with high quality materials and components, which can be recycled and reused.

...



1.1.6 End of use

2/4

When this crossed-out wheeled bin symbol is attached to a product it means that the product is covered by the European Directive 2002/96/EC.

...

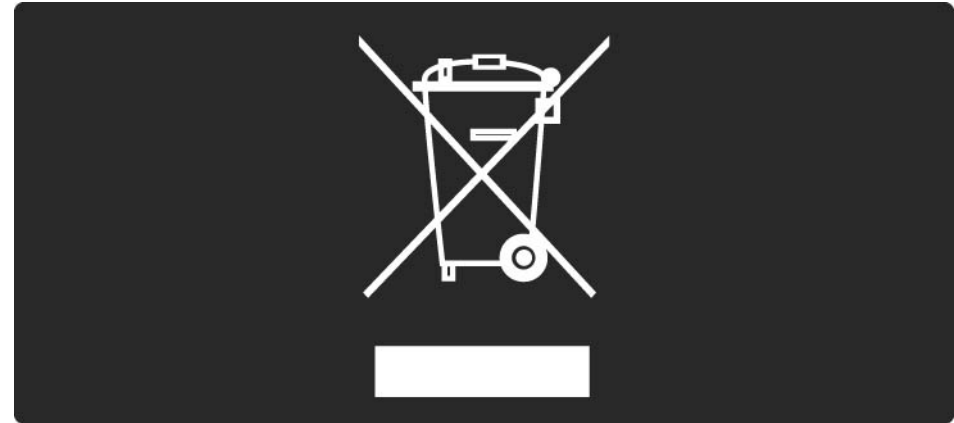

1.1.6 End of use

3/4

Please inform yourself about the local separate collection system for electrical and electronic products.

Please act according to your local rules and do not dispose of your old products with your normal household waste. Correct disposal of your old product helps to prevent potential negative consequences for the environment and human health.

...

1.1.6 End of use

Your product contains batteries covered by the European Directive 2006/66/EC, which cannot be disposed with normal household waste.

Please inform yourself about the local rules on separate collection of batteries because correct disposal helps to prevent negative consequences for the environmental and human health.



1.1.7 ECO - Green

1/2

This TV has features that contribute to energy-efficient use.

Energy efficiency features

- Ambient light sensor

To save energy, the built-in Ambient light sensor lowers the brightness of the TV screen when the surrounding light darkens.

- Standard

The standard setting of the TV combines several TV settings that result in saving energy. See the Smart settings in the Setup menu.

...

1.1.7 ECO - Green

2/2

- Low standby power consumption

The class-leading and highly-advanced power circuitry brings down the power consumption of the TV to an extremely low level, without losing out on the constant Standby functionality.

Power management

The advanced power management of this TV ensures the most efficient use of its energy. You can check how your personal TV settings, the level of brightness in current onscreen pictures, and the surrounding light conditions determine the relative power consumption.

Close this user manual and press Demo. Select Active control and press OK. Your current TV setting is highlighted. You can change to another setting to check the corresponding values.

1.2.1 Switch on

1/2

It takes a couple of seconds for the TV to start up.

If the red standby indicator is off, press  at the right of the TV to switch it on.

Press  again to switch off.

...

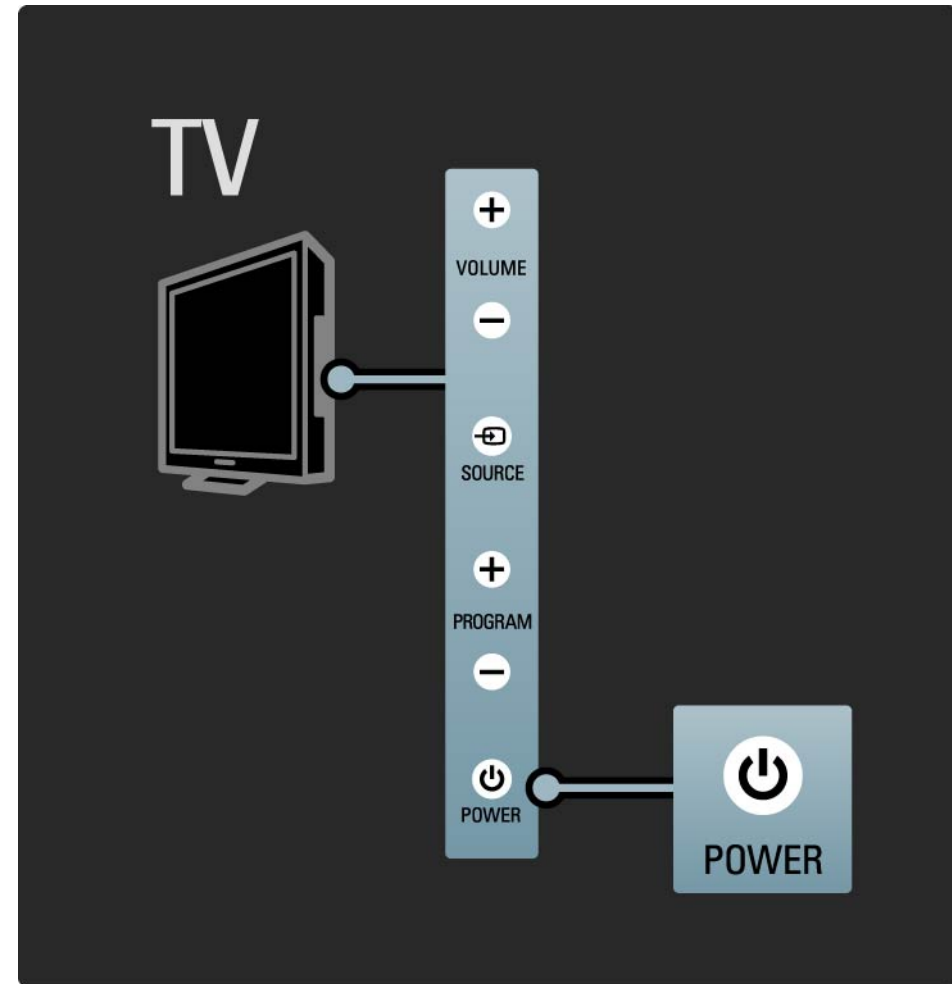

1.2.1 Switch on

2/2

The white LED flashes during start-up and switches off completely when the TV is ready for use. The Ambilight shows the TV is on.

You can set the white LED on permanently or set its brightness. Press  > Setup > Installation > Preferences > LightGuide brightness.

1.2.2 LightGuide

The LightGuide at the front of the TV indicates whether the TV is on or is starting up.

In the Setup menu, you can set the LightGuide brightness or let it switch off after start up.

Press **⌂** > Setup > Installation > Preferences > LightGuide brightness.

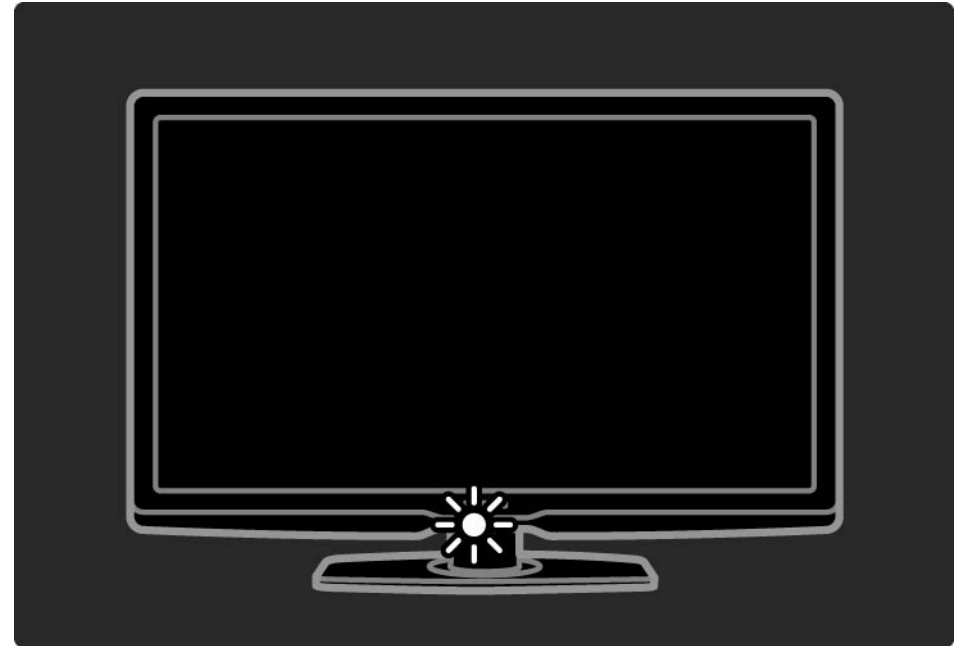

1.2.3 Volume

The keys on the side of the TV allow basic TV control.

You can adjust the volume with Volume + / - on the side of the TV.

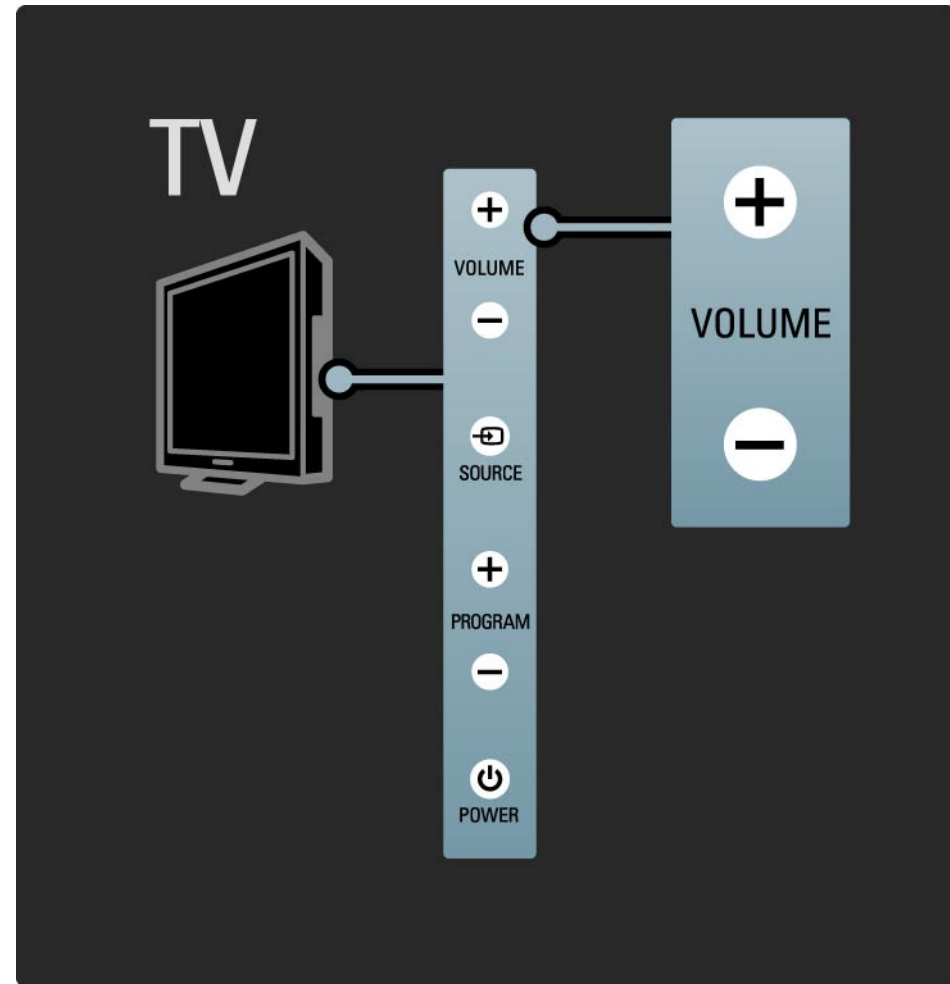

1.2.4 Programme P

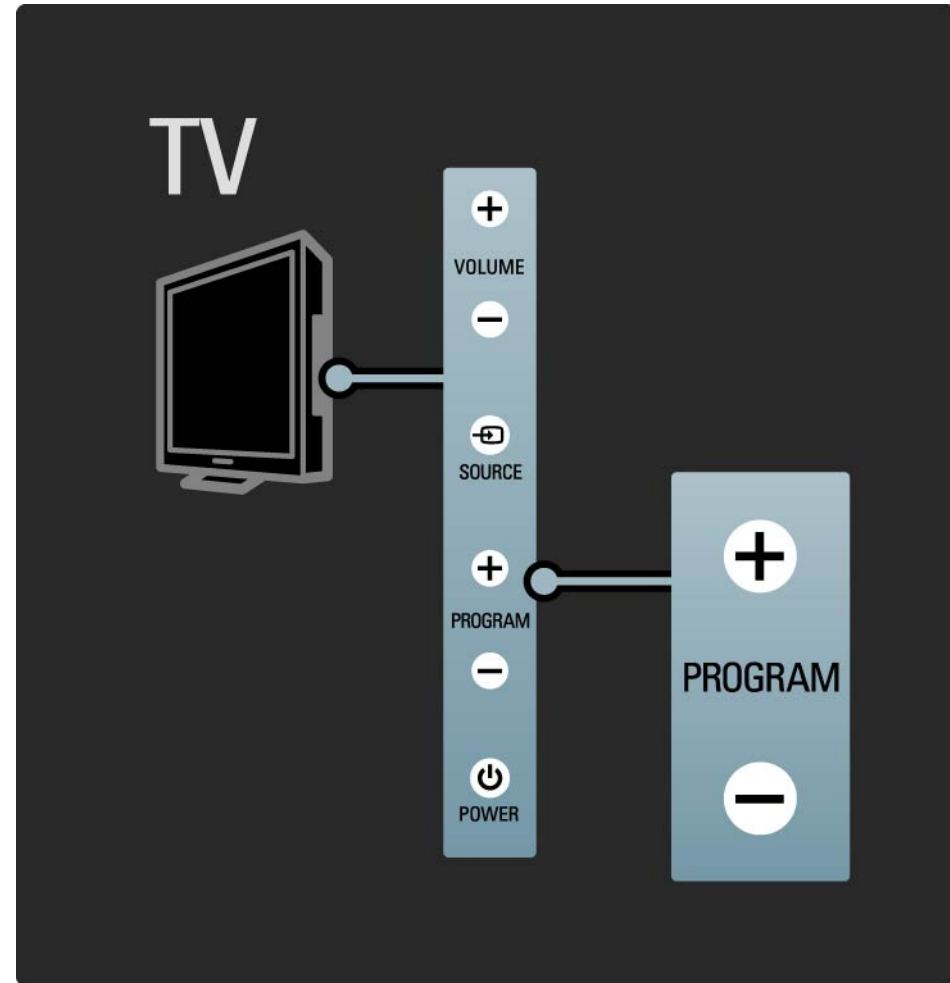

The keys on the side of the TV allow basic TV control.

You can switch TV channels with Program + / - on the side of the TV.



1.2.5 Source key

The keys on the side of the TV allow basic TV control.

To open the Source list to select a connected device, press Source . Press Source  again to select a connected device in the list. After a few seconds the TV switched to the selected device.

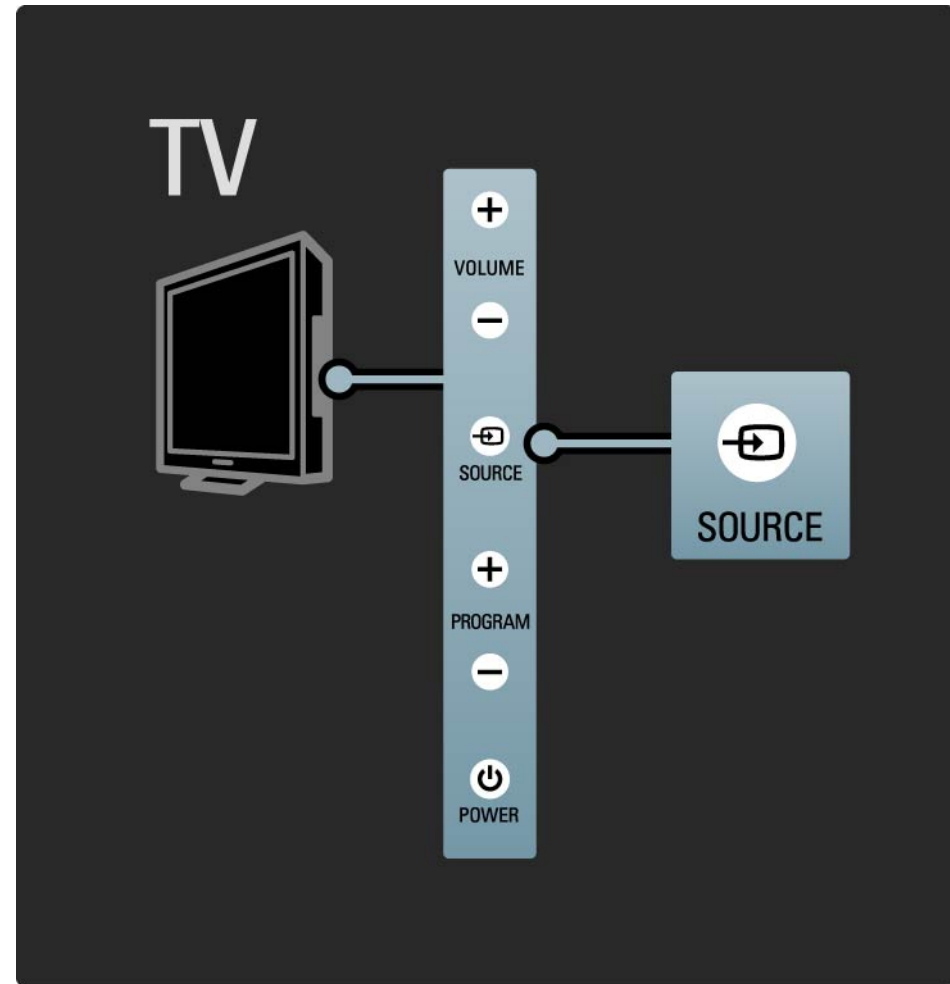

1.2.6 IR sensor

Always take care to point the remote control at the remote control infra red sensor on the front of the TV.

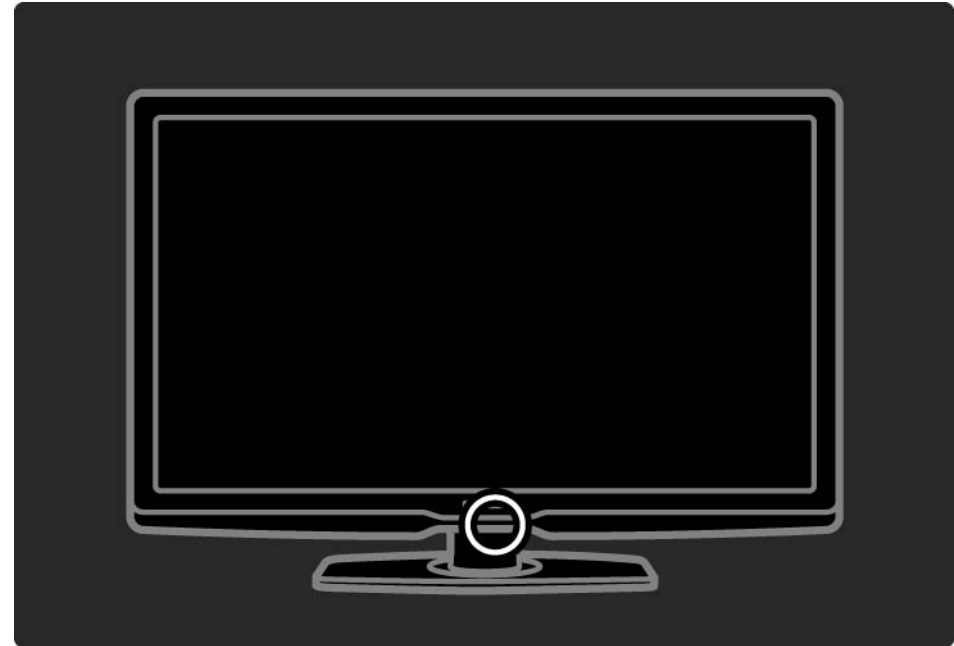

1.3.1 VESA info

Your TV is prepared for VESA compliant wall mounting. A VESA wall mount bracket is not included. Use the following VESA code to purchase the bracket.

42" / 107cm VESA MIS-F 300, 300, 6

47" / 119cm VESA MIS-F 300, 300, 6

52" / 132cm VESA MIS-F 400, 400, 8

When mounting the TV on a wall, always use all 4 fixing points on the back of the TV. Use a screw length as shown in the drawing.

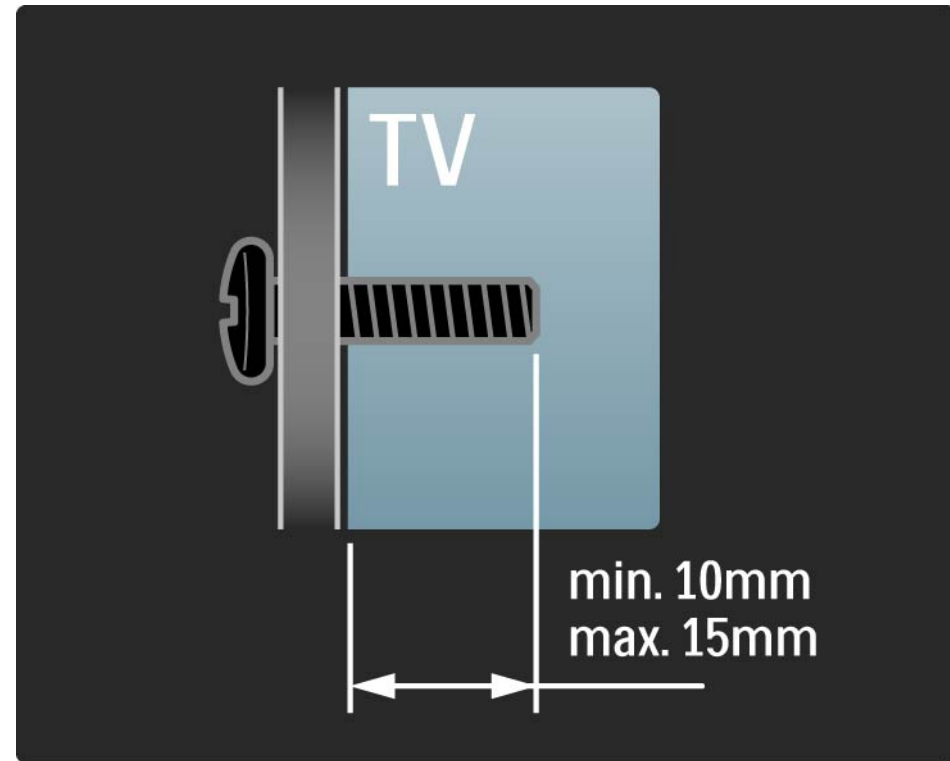

1.3.2 Unmount the stand

Before you lift the TV from the stand, unscrew the 4 stand screws on the back of the TV.

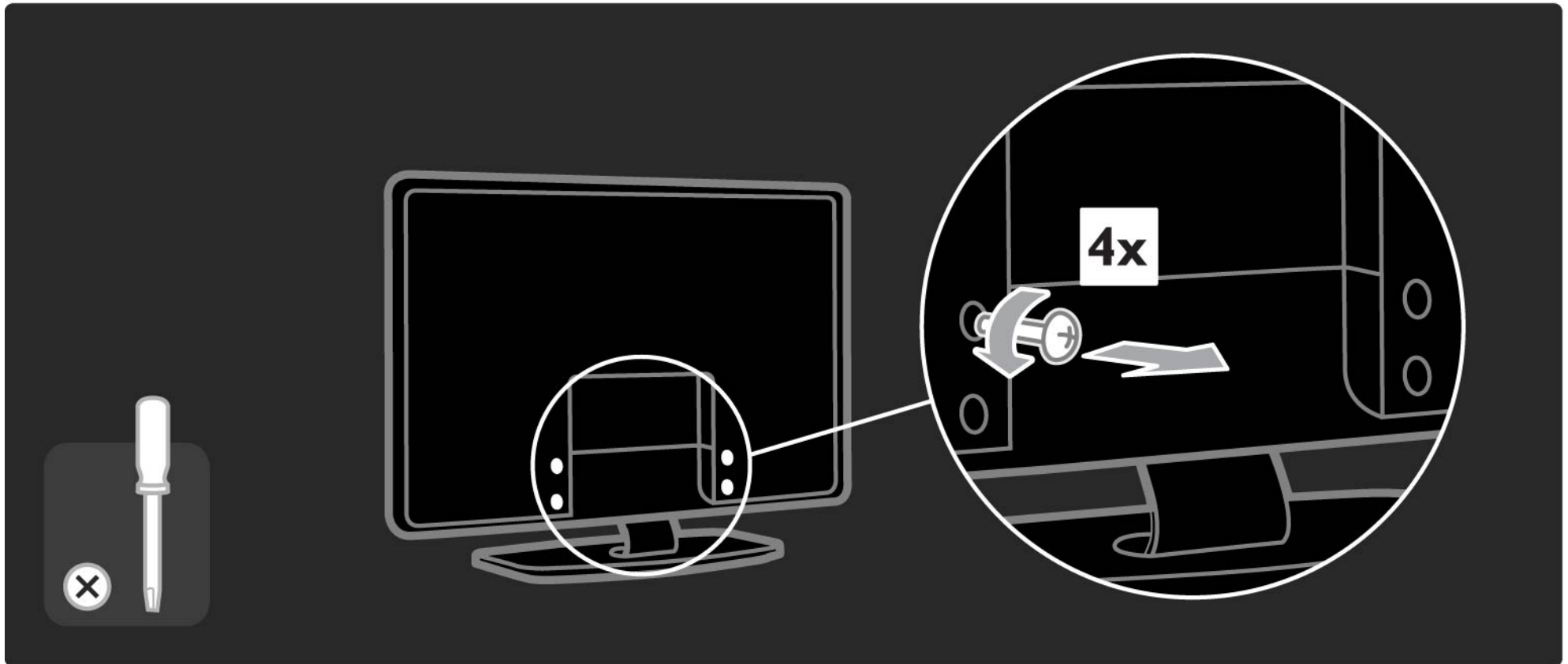

1.4.1 Full High Definition LCD display

This TV is equipped with a full High Definition (HD) display. A full HD 1920x1080p, the highest resolution of HD sources.

This display offers a brilliant flicker free progressive scan picture with optimum brightness and superb colours.

To enjoy HD TV you need to get programmes in HD first. If you are not watching HD programmes, the picture quality will be that of a normal TV.

Read [Get started > Important > Enjoy HD TV](#)

1.4.2 Ambilight

Ambilight is the lighting technology that emanates from the back of the television onto the wall. This innovative technology automatically adjusts the colour and brightness of the light to match the TV picture.

This creates an unprecedented improvement in viewing experience. The light also reduces eyestrain thus providing a more relaxing viewing experience.

Read more on Ambilight in Use your TV.

1.4.3 DVB-T and DVB-C integrated tuner

Next to normal analogue TV broadcast your TV can receive digital terrestrial (DVB-T) and in certain countries also digital cable (DVB-C) TV and radio broadcasts.

DVB — Digital Video Broadcasting gives you better picture and better sound quality.

Some broadcasters have several audio (speech) and/or teletext languages available.

Verify if the TV supports DVB-T or DVB-C in your country. Check the 'Digital TV Country Compatibility' sticker on the back of the TV.

1.4.4 Programme guide

The Programme guide is an onscreen guide to scheduled TV programmes. This guide is provided by digital broadcasters or the Net TV online service. You can read the programme summary, set a message to remind you when the programme starts or select programmes by genre.

Read More on ... > Programme guide.

1.4.5 Wireless network

Simply link up this TV to your wireless network at home. There is no need for a network cable. Enjoy your pictures, videos and music files from your PC on a big screen.

Read Setup > Network.

1.4.6 Net TV

You can link up your TV to Net TV.

The Net TV start page offers you movies, pictures, music, infotainment, games and many more, all set up for your TV screen.

To enjoy Net TV you need to connect the TV to a router connected to the Internet.

Read more on Net TV in [Use your TV > Net TV](#).

Read more on connecting to a router in [Setup > Network](#).

1.4.7 Scenea, USB and PC

Scenea

With Scenea, you can set a photo as a 'wallpaper' photo on your screen. Use any photo from your collection and create your own painting on the wall.

Read chapter [More on ... > Scenea](#).

USB and PC network connection

View or play your own multimedia files (photos, music, videos, ...) from the USB connection on the side of the TV.

Connect the TV to a home PC network and enjoy watching multimedia files stored on your PC.

1.4.8 Universal remote control

Your TV remote control is a universal remote control that can operate other devices such as DVD players and recorders, digital receivers (STB) or Home Theatre Systems (HTS). From Philips or other brands.

Read more on Universal remote control in [Get started > Remote control > Universal RC setup](#).

1.5.1 Onscreen

You are reading the built in user manual.

This manual contains all of the information needed to install and operate this TV.

You can open or close the user manual with the yellow  key on the remote control.

Before you carry out the instructions, close the manual with the yellow  key.

When you open the manual again, it opens on the same page you left it.

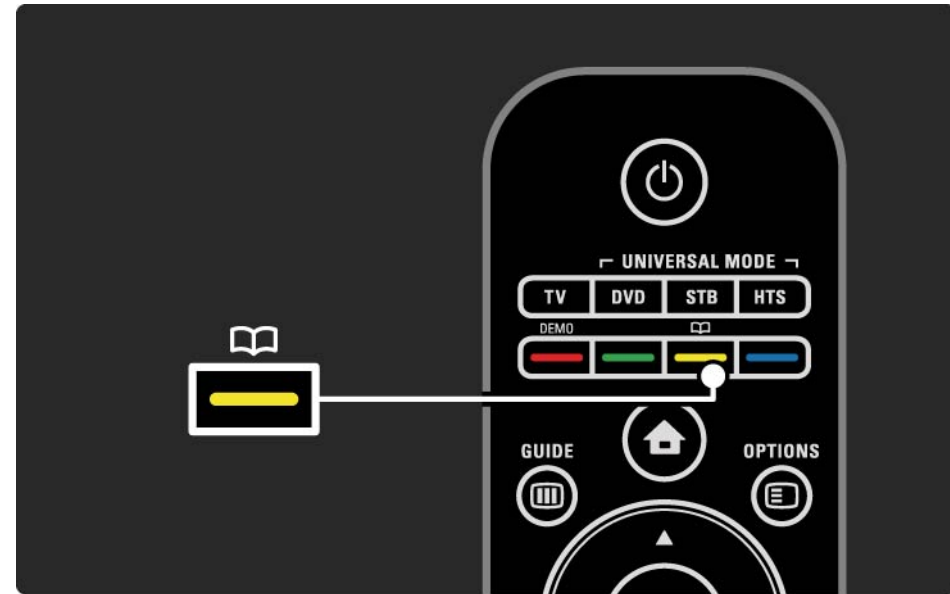

1.5.2 On the Internet

A printable version of the user manual is available on the Internet.

View or print the user manual at www.philips.com/support

2.1.1 Remote control overview

1/6

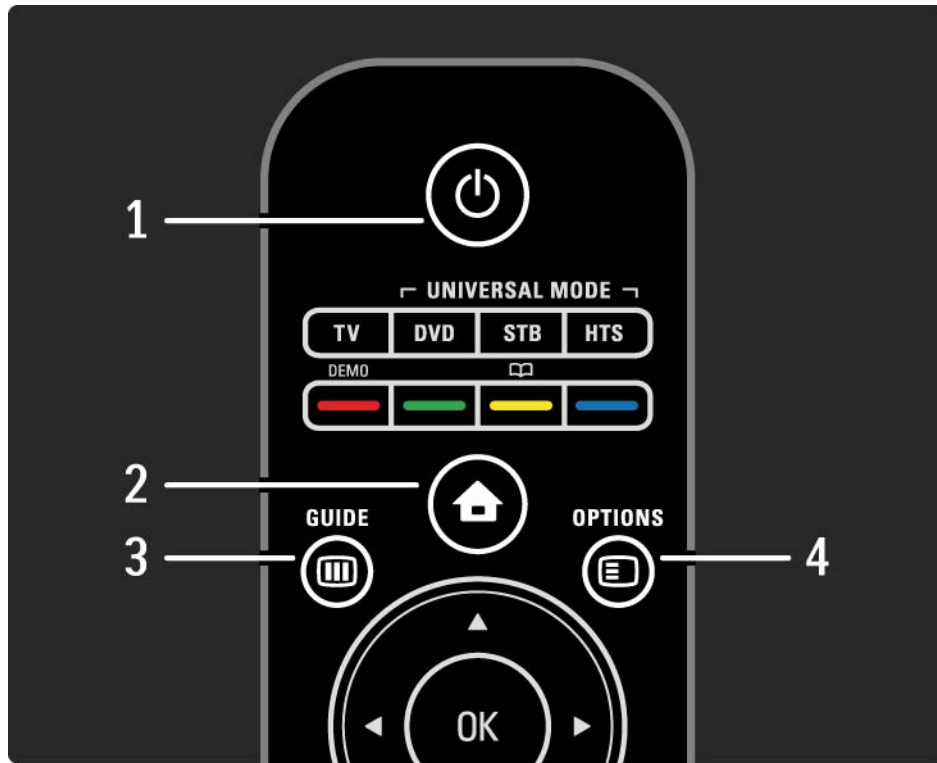

1 Standby 

To switch the TV on or back to standby.

2 Home 

To open or close the Home menu.

3 Guide 

To open or close the Programme Guide. To open or close the content list when you browse multimedia content.

4 Options 

To open or close the options menu which shows the available options.

...

2.1.1 Remote control overview

2/6

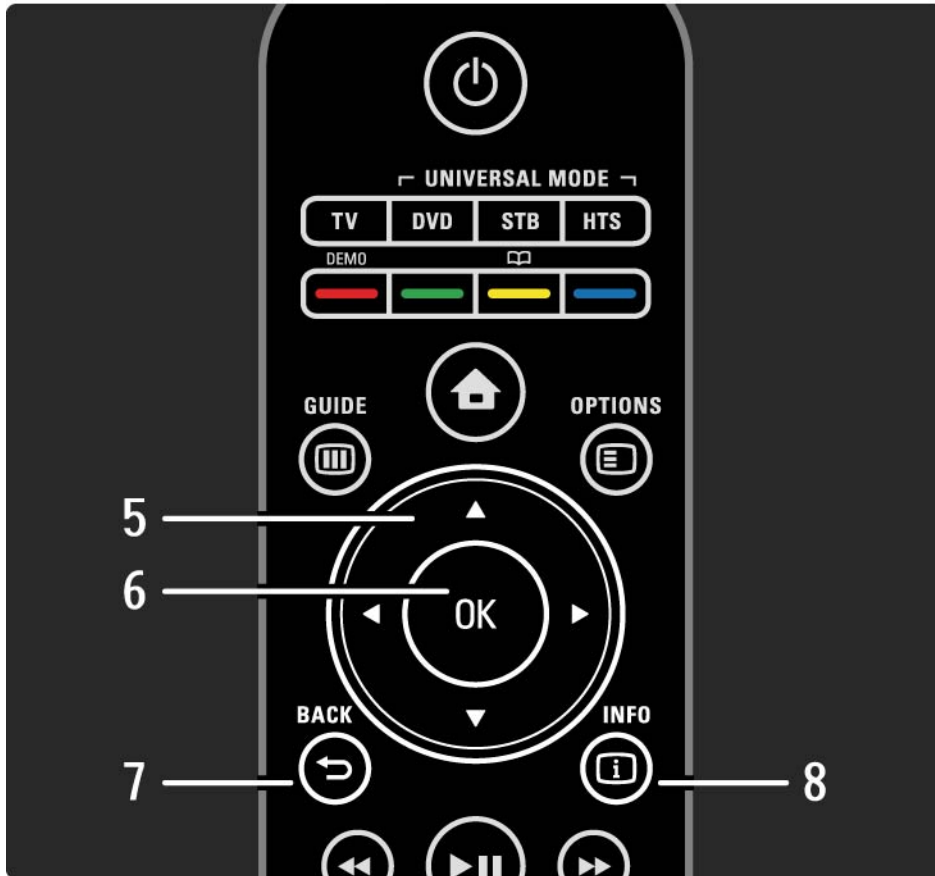

5 Navigation key

To navigate up, down, left or right.

6 OK key

To open or close the channel overview.

To activate a selection.

7 Back ↶

To go back or exit a menu without changing a setting.

To go back to the previous TV channel or the previous teletext page.

To go back to the previous Net TV page.

8 Info ⓘ

To open or close channel or programme information, if available.

...

2.1.1 Remote control overview

3/6

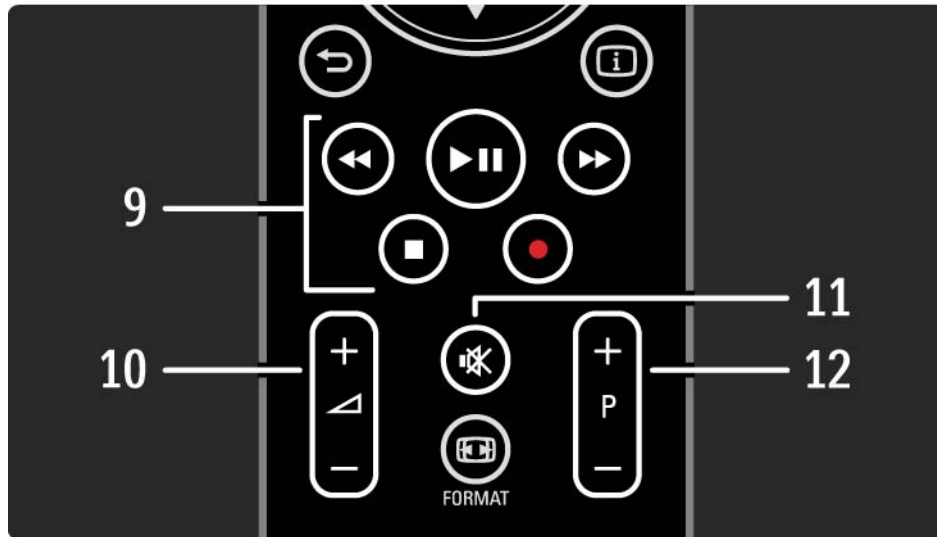

9 Audio Video keys ◀▶, ▶⏸, ▶▶, ■, ●

To play multimedia files.

To operate a disc player connected with EasyLink HDMI-CEC.

10 Volume ▲

To adjust the volume.

11 Mute 🔊

To mute the sound or restore it.

12 Channel / Programme up and down

To switch to the next or previous channel in the channel overview.

To switch to the next or previous teletext page.

...

2.1.1 Remote control overview

4/6

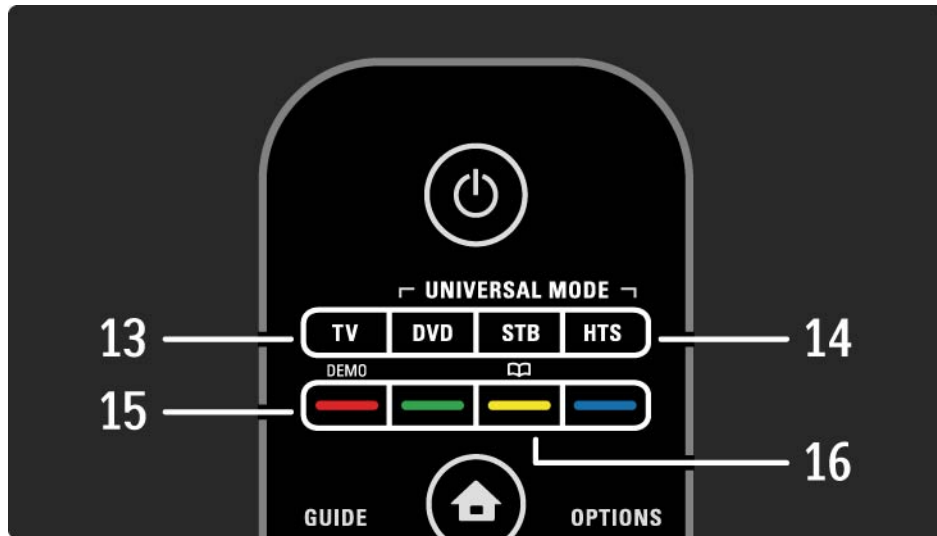

13 TV key

To set the remote control in TV mode.

14 DVD, STB and HTS keys

Universal remote control keys.

15 Colour keys

Easy selection of teletext pages.

To open or close the Demo menu (red key).

16 User manual  (yellow key)

To open or close the user manual

...

2.1.1 Remote control overview

5/6



17 Format 

To select a picture format.

18 Net TV

To open or close the Net TV start page.

19 Teletext

To switch teletext on or off.

20 Disc menu

To show the disc menu of a disc player connected with an HDMI cable with EasyLink set to On.

...

2.1.1 Remote control overview

6/6

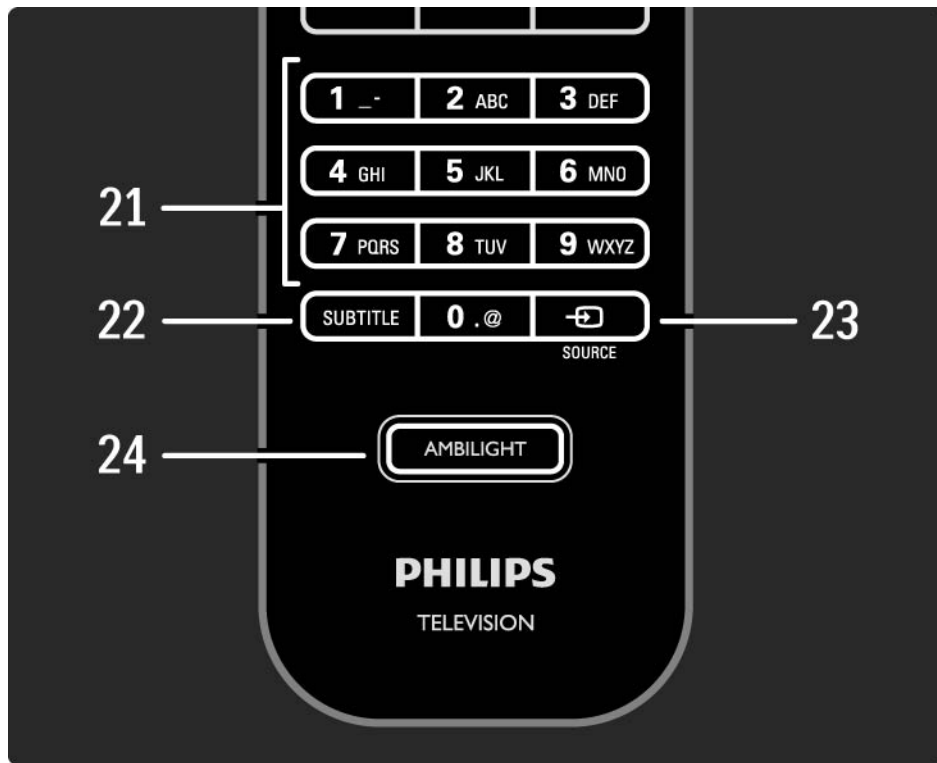

21 Number keys

To select a TV channel or enter digits.

22 Subtitle

To open the subtitle on / off menu.

23 Source

To select a connected device from the Source list.

24 Ambilight

To switch Ambilight on or off.

2.1.2 Universal remote control

1/4

Your TV remote control can control other devices such as a DVD player or a Home Theatre System from Philips or other brands.

To operate a device with the TV remote control, you need to set up one of the Universal mode keys for your particular device.

Once setup is complete, the Universal mode key sets the remote control to operate the device but the TV screen will not switch to that device.

...

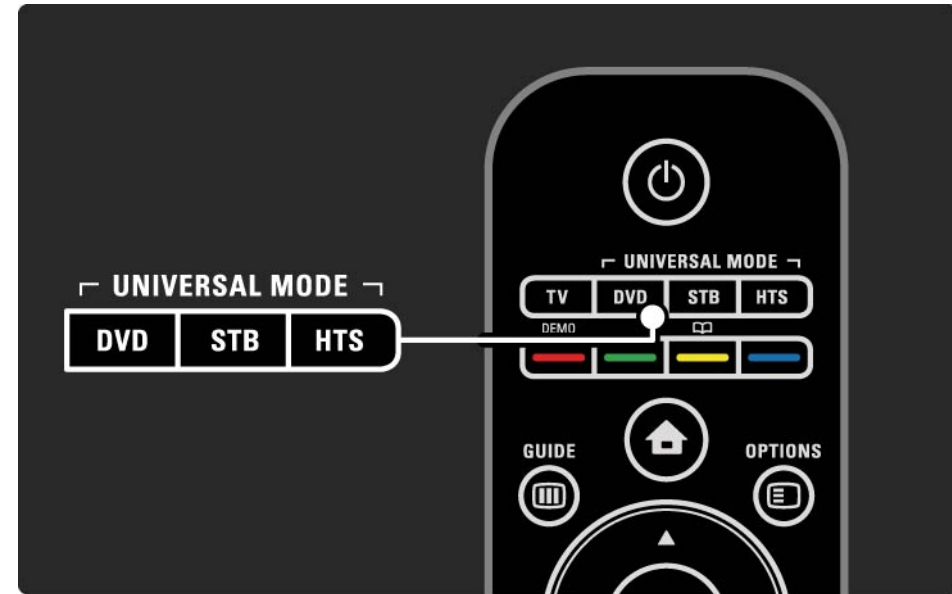

2.1.2 Universal remote control

2/4

DVD, STB or HTS key

Use the DVD key to operate a DVD player or Blu-ray Disc, the STB key for a set-top box or digital cable receiver and the HTS key for a Home Theatre System.

As long as the key blinks, you can control the device with the relevant keys on the remote control.

To return to normal TV control, press TV.

When no key is pressed for 30 seconds, the remote control switches back to TV control.

Setup for a particular device

To start the Universal mode key setup in the Home menu, press  > Setup > Installation > Universal remote control and press OK.

Follow the instructions on screen.

The TV will search for a suitable RC code for your device. When an RC code is found, you can try out the remote control keys for this device. If not all keys work, you can continue the search.

In some cases, there are no suitable RC codes available for some devices.

...

2.1.2 Universal remote control

3/4

Manual setup

You can manually enter an RC code to set up a Universal mode key. Look up the appropriate RC code in the Universal RC code list in this user manual. In the list, look for the type of device and brand you need. Some brands have several RC codes available. When setup is performed manually, try to operate the device with the relevant keys. If the device does not respond or operates incorrectly and there is more than 1 code available, you can restart the manual setup using another RC code.

To enter an RC code manually

1 Press the Universal mode key you want to set up, DVD, STB or HTS and press this key together with the OK key for 4 seconds simultaneously. All 4 keys light up for 1 second and the key you are setting stays lit.

2 Enter the 4-number RC code you found in the list.

3 If the code is accepted, all 4 keys blink 3 times. If you entered a code that does not exist, all keys blink for 2 seconds. You can re-enter a code.

4 If the code is accepted, the Universal mode key is set up.

...

2.1.2 Universal remote control

Warning

To avoid the loss of stored Universal remote control codes, do not leave the remote control without battery power for more than 5 minutes. Also during the replacement of the batteries, do not press any remote control key.

Dispose of batteries according to the end of use directives. Read chapter Get started > Important > End of use.

2.1.3 Universal RC code list

1/26

Use Manual setup to enter an RC code from the list hereafter. Read Get started > Remote control > Universal RC code list, Manual setup.

To setup the DVD key, first find the RC code for your DVD or Blu-ray Disc player in the DVD codes list.

See the lists for Digital receiver or Satellite receiver to setup the STB key. To setup the HTS key, see the list for Home Theatre System.

Write down the codes for your brand and device, close the user manual and try out the codes one by one until the setup is successful.

DVD codes

DVD player, DVD Recorder, DVD-R HDD, Blu-ray Disc player.

Philips - 0000, 0001, 0002, 0003, 0004, 0005, 0006, 0007, 0008, 0009, 0010, 0012, 0064, 0065, 0066, 0067, 0094, 0098, 0103, 0122, 0131, 0132, 0140, 0143, 0144, 0170, 0174, 0175, 0177, 0180, 0190, 0206, 0240, 0255, 0264, 0287, 0293, 0295, 0296, 0302, 0309, 0316, 0317, 0318, 0325, 0327, 0333, 0334

Philips Magnavox - 0094

4Kus - 0287

Acoustic Solutions - 0011

AEG - 0135

2.1.3 Universal RC code list

2/26

Airis - 0290

Aiwa - 0113, 0163, 0312, 0343

Akai - 0097

Akura - 0281

Alba - 0112, 0121, 0124, 0127, 0138

Alize - 0285

Amitech - 0135

AMOi - 0225

AMW - 0114, 0354

Andersson - 0355

Apex - 0107

Asono - 0290

ATACOM - 0290

Avious - 0288

Awa - 0114

Bang and Olufsen - 0291

Basic Line - 0356

CAT - 0272, 0273

Celestron - 0363

Centrex - 0158

Centrum - 0273, 0364

Baze - 0288

BBK - 0290

Bellagio - 0114

Best Buy - 0277

Boghe - 0289

BOSE - 0352, 0353, 0357, 0358, 0359,
0360, 0361, 0362

Bosston - 0271

Brainwave - 0135

Brandt - 0047, 0145, 0264

Britannia - 0268

Bush - 0121, 0127, 0134, 0169, 0176,
0265, 0267, 0275, 0279, 0288

Cambridge Audio - 0270

CGV - 0135, 0270

Cinetec - 0114

CineVision - 0278

Classic - 0104

Clatronic - 0275, 0288, 0365

Coby - 0284

Conia - 0265

Continental Edison - 0114

Crown - 0135, 0145

Crypto - 0280

C-Tech - 0142

CVG - 0135

CyberHome - 0061, 0062, 0063

Daenyx - 0114

Daewoo - 0092, 0114, 0135, 0186,
0193, 0195, 0348

Dalton - 0283

Dansai - 0135, 0269

Daytek - 0114, 0133, 0366

Dayton - 0114

DEC - 0275

Decca - 0135

Denon - 0118, 0205, 0209, 0214

Denon - 0118, 0205, 0209, 0214

2.1.3 Universal RC code list

3/26

Denver - 0124, 0203, 0275, 0281, 0284	Enzer - 0266	GVG - 0135
Denzel - 0266	Euroline - 0370	H and B - 0275, 0276
Desay - 0274	Finlux - 0135, 0270, 0288, 0371	Haaz - 0142, 0270
Diamond - 0142, 0270	Fintec - 0135, 0372	Harman/Kardon - 0350
Digitor - 0282Digix Media - 0367	Fisher - 0102	HiMAX - 0277
DK Digital - 0134, 0300	Futronic - 0373	Hitachi - 0022, 0095, 0106, 0121, 0172, 0188, 0202, 0218, 0266, 0277, 0311
Dmtech - 0091, 0368	Gericom - 0158	Hoehner - 0290
Dual - 0266, 0369	Giec - 0289	Home Tech Industries - 0290
DVX - 0142	Global Solutions - 0142	Humax - 0221
Easy Home - 0277	Global Sphere - 0142	Hyundai - 0224, 0286, 0374
Eclipse - 0270	Go Video - 0095	Infotech - 0375
E-Dem - 0290	GoldStar - 0033	Innovation - 0099, 0100, 0106
Electrohome - 0135	Goodmans - 0085, 0112, 0121, 0127, 0158, 0171, 0200, 0216, 0239, 0246, 0275, 0279, 0289	Jamo - 0376
Elin - 0135	Graetz - 0266	JBL - 0377
Elta - 0093, 0135, 0152, 0285	Grundig - 0098, 0158, 0162, 0173	Jeutech - 0271
Eltax - 0297, 0366	Grunkel - 0135, 0286	
Emerson - 0101		

2.1.3 Universal RC code list

4/26

JVC - 0054, 0055, 0056, 0057, 0058,
0059, 0060, 0079, 0080, 0081, 0082,
0141, 0153, 0157, 0161, 0164, 0165,
0166, 0167, 0247, 0248, 0249, 0250,
0251, 0252, 0253, 0254, 0264, 0301,
0337

Kansai - 0284

KEF - 0378

Kennex - 0135

Kenwood - 0159, 0220, 0308, 0379

KeyPlug - 0135

Kiiro - 0135

Kingavon - 0275

Kiss - 0266, 0276

Koda - 0275

KXD - 0277

Lawson - 0142

Lecson - 0269

Lenco - 0135, 0275, 0288

Lenoxx - 0380

LG - 0031, 0032, 0033, 0071, 0101,
0117, 0137, 0204, 0229, 0234, 0258,
0313, 0329, 0330, 0331, 0336

Life - 0099, 0100

Lifetec - 0099, 0100, 0106

Limit - 0142

Linn - 0381

Liteon - 0287

Loewe - 0098, 0175, 0213, 0382

LogicLab - 0142

Lumatron - 0383

Luxor - 0158

Magnavox - 0264, 0275, 0293

Magnex - 0288

Magnum - 0106

Majestic - 0284

Marantz - 0009, 0103, 0211, 0212

Marquant - 0135

Matsui - 0145, 0235

MBO - 0110

Mecotek - 0135

Mediencom - 0268

Medion - 0099, 0100, 0106, 0279,
0384

Metz - 0096

MiCO - 0270, 0289, 0385

Micromaxx - 0099, 0100, 0106

Micromedia - 0264

Micromega - 0009

Microstar - 0099, 0100, 0106

Minoka - 0135

Minowa - 0288

Mirror - 0279

Mivoc - 0386

Mizuda - 0275, 0277

2.1.3 Universal RC code list

5/26

Monyka - 0266

Mustek - 0104, 0112, 0304

Mx Onda - 0270

Mystral - 0286

NAD - 0109, 0387

Naiko - 0135, 0158

Nakamichi - 0111, 0388

Neufunk - 0266

Nevir - 0135

Next Base - 0226

NU-TEC - 0265

Omni - 0268

Onkyo - 0215, 0264, 0293

Oopla - 0287

Optim - 0269

Optimus - 0294

Orava - 0275

Orbit - 0114

Orion - 0176

Oritron - 0100

P and B - 0275

Pacific - 0142

Palladium - 0389

Palsonic - 0267

Panasonic - 0026, 0027, 0028, 0029,
0030, 0118, 0120, 0125, 0126, 0128,
0129, 0130, 0189, 0201, 0241, 0243,
0244, 0245, 0259, 0260, 0261, 0298,
0303, 0319, 0320, 0321, 0322, 0323,
0326, 0335, 0342, 0344

peeKTON - 0290, 0390

Pensonic - 0227

Phonotrend - 0288

Pioneer - 0034, 0035, 0036, 0037,
0038, 0039, 0040, 0072, 0073, 0074,
0075, 0096, 0115, 0119, 0154, 0155,
0156, 0191, 0192, 0196, 0197, 0198,
0236, 0294, 0314, 0332

Pointer - 0135

Polaroid - 0222

Portland - 0135

Powerpoint - 0114

Proline - 0158

Promax - 0223

Prosonic - 0135, 0284

Provision - 0275

Raite - 0266

REC - 0267, 0268

RedStar - 0135, 0281, 0284, 0391

Reoc - 0142

2.1.3 Universal RC code list

6/26

Revoy - 0276

Rimax - 0285

Roadstar - 0121, 0267, 0275

Ronin - 0114

Rowa - 0158, 0265

Rowsonic - 0273

Saba - 0047, 0145

Sabaki - 0142

Saivod - 0135

Sampo - 0105

Samsung - 0022, 0023, 0024, 0025,
0076, 0077, 0078, 0095, 0123, 0136,
0151, 0184, 0194, 0207, 0217, 0307,
0340, 0341, 0349

Sansui - 0135, 0142, 0270, 0392

Sanyo - 0147, 0150, 0181, 0185, 0306

ScanMagic - 0112

Scientific Labs - 0142

Scott - 0124, 0283

Seeltech - 0290

SEG - 0090, 0114, 0121, 0142, 0179,
0266

Sharp - 0099, 0109, 0149, 0168, 0178,
0199, 0210, 0230, 0231, 0256, 0257,
0262

Sherwood - 0108

Sigmatek - 0277, 0290

Silva - 0281

Singer - 0142, 0270

Skymaster - 0104, 0142

Skyworth - 0281

Slim Art - 0135

SM Electronic - 0142

Sontech - 0286

Sony - 0013, 0014, 0015, 0016, 0017,
0018, 0019, 0020, 0021, 0068, 0069,
0070, 0113, 0116, 0139, 0146, 0148,
0183, 0232, 0242, 0299, 0305, 0310,
0324, 0328, 0346

Soundmaster - 0142

Soundmax - 0142

Spectra - 0114

Standard - 0142

Star Cluster - 0142

Starmedia - 0275, 0290

Sunkai - 0135

Supervision - 0142

Synn - 0142

T.D.E. Systems - 0286

T+A - 0393

Tatung - 0135

2.1.3 Universal RC code list

7/26

TCM - 0023, 0099, 0100, 0106, 0292, 0397

Teac - 0096, 0142, 0208, 0265, 0394

Tec - 0281

Technics - 0118

Technika - 0135, 0288

Telefunken - 0273

Tensai - 0135

Tevion - 0099, 0100, 0106, 0142, 0283

Thomson - 0046, 0047, 0048, 0049, 0050, 0051, 0052, 0053, 0083, 0084, 0233, 0263, 0339, 0347

Tokai - 0266, 0281

Top Suxess - 0290

Toshiba - 0012, 0041, 0042, 0043, 0044, 0045, 0086, 0087, 0088, 0089, 0094, 0182, 0187, 0219, 0237, 0238, 0264, 0293, 0345

TRANS-continents - 0114, 0288

Transonic - 0288

Trio - 0135

TruVision - 0277

TSM - 0290

Umax - 0285

Union - 0351

United - 0288

Universum - 0395

Viewmaster - 0290

Vtrek - 0280

Waitec - 0290

Welltech - 0289

Wharfedale - 0142, 0270

Wintel - 0271

Woxter - 0285, 0290

Xbox - 0048

Xenon - 0228

Xlogic - 0135, 0142

XMS - 0135, 0267

Xoro - 0289, 0396

Yakumo - 0158

Yamada - 0114, 0158, 0285, 0287

Yamaha - 0009, 0118, 0120, 0315, 0338

Yamakawa - 0114, 0266

Yukai - 0112, 0160

Zenith - 0101, 0264, 0293

2.1.3 Universal RC code list

8/26

STB

Digital receiver

STB codes

Philips - 0432, 0436, 0437, 0439, 0506

ABC - 0448

ADB - 0461, 0462

Alcatel - 0463, 0540

Allegro - 0464

Amstrad - 0431, 0449

Andover - 0452

Arcon - 0431

Atlanta - 0465

Auna - 0466

Axis - 0431

BBT - 0467

Belgacom TV - 0468

Bell Atlantic - 0453

Birmingham Cable Communications
- 0451

British Telecom - 0448

BT Cable - 0448

Cabletime - 0538

Clyde - 0454

Clyde Cablevision - 0443

Comcrypt 0442, 0469

Connect TV - 0470

Coship - 0471

Cryptovision - 0444, 0472

Daehan - 0473

Decsat - 0474

Digi1 - 0475

Eastern - 0476

Electricord - 0477

Electus - 0455

Fastweb - 0478

Fidelity - 0431

Filmnet - 0442

Filmnet Cablecrypt - 0445, 0539

Filmnet Comcrypt - 0445

Finlux - 0434

Foxtel - 0449

France Telecom - 0437, 0439, 0479

Freebox - 0450, 0480

GC Electronics - 0481

GE - 0482

GEC - 0443, 0454

General Instrument - 0433, 0448,
0483

Golden Channel - 0461

Gooding - 0432

Grundig - 0431, 0432

Hirschmann - 0434

2.1.3 Universal RC code list

9/26

Hitachi - 0484	Medion - 0495	Orange - 0534
HomeChoice - 0441, 0485	Minerva - 0432	Pace - 0535
Humax - 0486, 0487	Mnet - 0442, 0539	Pacific - 0505
HyperVision - 0435	Mood - 0496	Palladium - 0432
ITT Nokia - 0434	Motorola - 0497	Pioneer - 0431
Jerrold - 0433, 0448, 0536	Movie Time - 0447	Prelude - 0507
Jiuzhou - 0488	Mr Zapp - 0439	Protelcon - 0508
JVC - 0432	Multichoice - 0442	PVP Stereo Visual Matrix - 0536
Kabel Deutschland - 0489, 0490	NEC - 0498	Regency - 0509
Kansalaisboksi - 0491	Neuf Telecom - 0533	Sagem - 0439
LG Alps - 0492	Nokia - 0434, 0499	Samsung - 0440, 0502
Macab - 0439	Noos - 0439	SAT - 0431
Maestro - 0493	Northcoast - 0500	Satbox - 0458
Magnavox - 0494	Novaplex - 0501	Satel - 0459
Maspro - 0432	Now - 0502	Scientific Atlanta - 0446
Matav - 0462	NTL - 0456	Seam - 0510
Matsui - 0432	Omniview - 0503	Sharp - 0511
Maxdome - 0489	Ono - 0457, 0504	SingTel - 0512

2.1.3 Universal RC code list

10/26

SkyCable - 0513

Skyworth - 0514

Starcom - 0448

Stargate - 0515

Stellar One - 0516

TaeKwang - 0517

Tandy - 0518

Tatung - 0519

Teknika - 0520

Tele+1 - 0442, 0445, 0539

Telefonica - 0460

Telegent - 0521

Telenet - 0522

Telepiu - 0442, 0539

Thomson - 0438

Timeless - 0476

Tiscali - 0523

Tocom - 0524

Torx - 0448

Tudi - 0435

Uniden - 0525

United Cable - 0536

Universal - 0526

Universum - 0432, 0434

Videoway - 0537

VideoWorks - 0527

Vidtech - 0528

Viewstar - 0529

Vision - 0530

Visionetics - 0531

Visiopass - 0434, 0437, 0439

Wittenberg - 0431

Zenith - 0532

STB

Satellite receiver

STB codes

Philips - 0000, 0001, 0002, 0008, 0020, 0054, 0065, 0069, 0070, 0072, 0075, 0077, 0111, 0119, 0136, 0140, 0144, 0155, 0156, 0159, 0163, 0165, 0388, 0390, 0391, 0392, 0396, 0410, 0412, 0420, 0422, 0423, 0427

AB Sat - 0163, 0164, 0173, 0425

Action - 0187

ADB - 0175, 0188

Aegir - 0189

AGS - 0163

Akai - 0054, 0391

Akura - 0190

2.1.3 Universal RC code list

11/26

Alba - 0015, 0019, 0020, 0021, 0023,
0044, 0067, 0164, 0234, 0412

Aldes - 0021, 0023, 0024, 0234, 0395

Allantide - 0191

Allegro - 0192

Allsat - 0040, 0054, 0193, 0384, 0390,
0391

Allsonic - 0010, 0023, 0028, 0395,
0402

Alltech - 0164, 0414

Alpha - 0391

Altai - 0403

Amino - 0194

Amitronica - 0164

Ampere - 0153, 0403

Amstrad - 0026, 0055, 0074, 0108,
0153, 0158, 0164, 0169, 0195, 0394,
0399, 0403, 0415, 0417, 0421, 0426

Amway - 0196

Anglo - 0164

Ankaro - 0010, 0023, 0028, 0164,
0197, 0392, 0395, 0402

AntSat - 0198

Anttron - 0019, 0023, 0390, 0412

AnySat - 0199

Apollo - 0019

Arcon - 0027, 0041, 0153, 0419

Arion - 0200

Ariza - 0201

Armstrong - 0026, 0391

Arrox - 0202

ASA - 0404

Asat - 0054, 0391

ASCI - 0203

ASLF - 0164

AST - 0031, 0204, 0397

Astacom - 0163, 0420

Aston - 0022, 0205

Astra - 0026, 0029, 0030, 0050, 0161,
0164, 0206, 0387, 0400, 0407

Astratec - 0207

Astro - 0010, 0023, 0024, 0028, 0033,
0155, 0156, 0158, 0161, 0208, 0388,
0402, 0412

Atlanta - 0209

AudioTon - 0023, 0040, 0412

Aurora - 0168, 0210

Austar - 0071, 0168, 0211

Avalon - 0403

Axial - 0163

2.1.3 Universal RC code list

12/26

Axil - 0212

Axis - 0010, 0028, 0030, 0036, 0401,
0402, 0407

B and K - 0213

Barcom - 0027

BeauSAT - 0212

BEC - 0214

Beko - 0215

Belgacom TV - 0216

Belson - 0217

Benjamin - 0218

Best - 0010, 0027, 0028, 0402

Best Buy - 0219

Big Brother - 0191

Blackbird - 0220

Blaupunkt - 0033, 0155, 0388

Blue Sky - 0164, 0169

Boca - 0026, 0050, 0153, 0164, 0221,
0378, 0410, 0416

Boom - 0222

BOSE - 0223

Boston - 0153, 0163, 0224

Brain Wave - 0035, 0398, 0419

Brandt - 0056

Broadcast - 0034, 0400

Broco - 0164, 0407

BSkyB - 0074, 0084, 0426

BT - 0066, 0163

BT Satellite - 0420

Bubu Sat - 0164

Bush - 0020, 0044, 0090, 0234, 0384,
0390

BVV - 0419

Cable Innovations - 0225

Cambridge - 0158, 0226, 0416

Camundosat - 0227

Canal Digital - 0176, 0180, 0181

Canal Satellite - 0005, 0156, 0396,
0427

Canal+ - 0156, 0228

CCI - 0229

cello - 0230

CellularVision - 0231

Century - 0232

CGV - 0233

Channel Master - 0021, 0234

Chaparral - 0052, 0235

CHEROKEE - 0163, 0173

Chesley - 0212

Chess - 0154, 0160, 0164, 0221

Chili - 0236

Churchill - 0237

Citizen - 0238

2.1.3 Universal RC code list

13/26

CityCom - 0020, 0037, 0071, 0152,
0161, 0165, 0423

Clatronic - 0035, 0398

Clemens Kamphus - 0046

CNT - 0024

Colombia - 0153

Columbia - 0153

COLUMBUS - 0043

Comag - 0153, 0221, 0239

Commander - 0392

Commlink - 0023, 0395

Comtec - 0036, 0395, 0401

Condor - 0010, 0028, 0161, 0240, 0402

Connexions - 0010, 0032, 0402, 0403

Conrad - 0010, 0152, 0153, 0158,
0161, 0402, 0409, 0410

Conrad Electronic - 0161, 0164

Contec - 0036, 0037, 0401, 0410

Continental Edison - 0241

Cosat - 0040

Coship - 0212

Crown - 0026, 0242

CyberHome - 0243

Cybermaxx - 0062

Cyrus - 0174

Daeryung - 0032

Daewoo - 0066, 0164, 0244

Dansat - 0384, 0390

D-Box - 0245, 0429

DDC - 0021, 0234

Decca - 0038

Delega - 0021

Demo - 0246

Dew - 0036, 0401

DGStation - 0086

Diamond - 0039

Digenius - 0247

Digitality - 0161, 0248

Digiline - 0249

DigiO2 - 0250

Digipro - 0170

DigiQuest - 0251

DigitAll World - 0252

Digiturk - 0253

Dilog - 0254

DiPro - 0212

Discoverer - 0154, 0160

Discovery - 0163

Diseqc - 0163

Diskxpress - 0027

Distratel - 0169

Distrisat - 0391

Ditristrad - 0040

2.1.3 Universal RC code list

14/26

DNR - 0419	Elta - 0010, 0019, 0028, 0040, 0054, 0261, 0391, 0402	Eurosky - 0010, 0026, 0028, 0152, 0153, 0158, 0161, 0402
DNT - 0032, 0054, 0391, 0403	Emanon - 0019	Eurospace - 0042
Dong Woo - 0049	Emme Esse - 0010, 0028, 0046, 0162, 0402, 0428	Eurostar - 0026, 0152, 0161, 0162, 0165, 0430
Drake - 0041, 0255	Engel - 0164, 0262	Euskaltel - 0267
DStv - 0168, 0256	Ep Sat - 0020	Eutelsat - 0164
Dual - 0257	Erastar - 0263	Eutra - 0414
Dune - 0010, 0402	EURIEULT - 0013, 0108, 0169	Exator - 0019, 0023, 0412
Dynasat - 0162	Euro1 - 0264	Fast - 0268
DynaStar - 0258	Eurocrypt - 0387	Fenner - 0010, 0154, 0160, 0164
Echostar - 0032, 0164, 0173, 0403, 0427, 0428	Eurodec - 0060, 0265	Ferguson - 0020, 0060, 0114, 0384, 0390
EIF - 0259	Europa - 0158, 0161, 0391, 0392, 0410	Fidelity - 0158, 0394, 0415
Einhell - 0019, 0023, 0026, 0153, 0158, 0164, 0394, 0395	European - 0064	Finepass - 0269
Elap - 0163, 0164	Europhon - 0153, 0161	Finlandia - 0020, 0387
Electron - 0260	Europlus - 0266	Finlux - 0020, 0387, 0405, 0409
Elekta - 0024	Eurosat - 0026	FinnSat - 0036, 0060, 0270
Elsat - 0164, 0417		

2.1.3 Universal RC code list

15/26

Flair Mate - 0164

Fortec Star - 0198

Foxtel - 0071, 0168, 0172

Fracarro - 0271, 0428

France Satellite/TV - 0043

Freecom - 0019, 0045, 0155, 0158

Freesat - 0108, 0414

FTE - 0047, 0402, 0410, 0416

FTEmaximal - 0010, 0164

Fuba - 0010, 0019, 0027, 0028, 0029,
0032, 0033, 0043, 0054, 0152, 0155,
0387, 0402, 0403

Fugionkyo - 0170

Fujitsu - 0182

Galaxi - 0027

Galaxis - 0010, 0023, 0028, 0030,
0036, 0040, 0044, 0059, 0071, 0127,
0152, 0168, 0395, 0401, 0402, 0407

Galaxisat - 0397

Gardiner - 0165

Gecco - 0272

General Instrument - 0273

Gensat - 0274

Geotrack - 0275

Globo - 0276

GMI - 0026

Goldbox - 0156, 0396, 0427

Golden Interstar - 0277

GoldStar - 0045

Gooding - 0159

Goodmans - 0015, 0016, 0020, 0044

Gould - 0278

Granada - 0387

Grandin - 0013, 0385

Grothusen - 0019, 0045

Grundig - 0020, 0023, 0033, 0055,
0074, 0099, 0100, 0101, 0109, 0133,
0148, 0155, 0158, 0159, 0168, 0169,
0388, 0399, 0422, 0426

G-Sat - 0390

Hanseatic - 0160, 0279, 0411

Haensel and Gretel - 0153, 0161

Hantor - 0019, 0035, 0049, 0398

Hanuri - 0024

Harting und Helling - 0046

Hase and Igel - 0419

Hauppauge - 0089, 0113

Heliocom - 0161, 0280

Helium - 0161

Hinari - 0021, 0234, 0390

2.1.3 Universal RC code list

16/26

Hirschmann - 0010, 0033, 0046, 0098,
0108, 0155, 0158, 0161, 0163, 0388,
0403, 0404, 0406, 0409

Hisawa - 0035, 0398

Hitachi - 0020, 0281

Hivion - 0282

HNE - 0153

Homecast - 0283

Houston - 0040, 0284, 0392

Humax - 0011, 0012, 0050, 0071,
0085, 0086, 0094, 0097, 0121, 0122,
0123, 0124, 0128, 0129, 0149

Huth - 0023, 0026, 0034, 0035, 0036,
0040, 0046, 0153, 0161, 0171, 0392,
0395, 0398, 0400, 0401, 0410

Hypson - 0013

ID Digital - 0071

Imex - 0013

Imperial - 0044

Ingelen - 0108

Innovation - 0028, 0059, 0062

InOutTV - 0285

International - 0153

Interstar - 0170

Intertronic - 0026, 0286

Intervision - 0040, 0161, 0413

Inverto - 0287

InVideo - 0179

IRTE - 0288

ITT Nokia - 0020, 0387, 0404, 0409,
0429

Janeil - 0289

Jazztel - 0290

Johansson - 0035, 0398

JOK - 0163, 0418, 0420

JSR - 0040

JVC - 0015, 0159, 0291

Kamm - 0164

Kaon - 0292

Kathrein - 0033, 0037, 0047, 0052,
0054, 0068, 0073, 0080, 0091, 0092,
0093, 0095, 0118, 0120, 0130, 0131,
0152, 0155, 0163, 0164, 0165, 0173,
0388, 0391, 0406, 0412, 0423

Kathrein Eurostar - 0152

Kenwood - 0176, 0293

Key West - 0153

Klap - 0163

Kolon - 0177

Konig - 0161, 0294

Kosmos - 0045, 0046, 0047, 0295,
0406

2.1.3 Universal RC code list

17/26

KR - 0023, 0412, 0414

Kreatel - 0296

Kreiselmeier - 0033, 0155, 0388

K-SAT - 0164

Kyostar - 0019, 0153, 0297, 0412

L and S Electronic - 0010, 0153

Lasat - 0010, 0024, 0028, 0048, 0049,
0050, 0056, 0152, 0153, 0154, 0161,
0401, 0402, 0416

Lemon - 0419

Lenco - 0010, 0019, 0045, 0051, 0152,
0161, 0164, 0257, 0392, 0402, 0407,
0419

Leng - 0035

Lennox - 0040

Lenson - 0158

Lexus - 0391

LG - 0045, 0208

Life - 0059

Lifesat - 0010, 0028, 0059, 0062, 0153,
0154, 0160, 0164, 0402, 0411

Lifetec - 0028, 0059, 0062

Lion - 0042, 0191

Loewe - 0147

Lorenzen - 0153, 0161, 0298, 0392,
0419, 0421

Lorraine - 0045

Lupus - 0010, 0028, 0402

Luxor - 0158, 0387, 0399, 0409, 0429

Luxorit - 0299

LuxSAT - 0300

Lyonnaise - 0060

M and B - 0160, 0411

M Technologies - 0301

Macab - 0060

Macom - 0183

Manata - 0013, 0153, 0163, 0164, 0420

Manhattan - 0020, 0024, 0040, 0163,
0420

Marann - 0302

Marantz - 0054

Marks and Spencer - 0303

Mascom - 0024, 0406

Maspro - 0020, 0052, 0155, 0159,
0164, 0386, 0388, 0414, 0419

Master's - 0037

Matsui - 0155, 0159, 0163, 0234,
0388, 0420

Max - 0161

Maxi - 0304

MB - 0160, 0411

Mediabox - 0156, 0396, 0427

2.1.3 Universal RC code list

18/26

Mediamarkt - 0026

Mediasat - 0030, 0156, 0158, 0396,
0407, 0427

Medion - 0010, 0028, 0059, 0062,
0132, 0153, 0164, 0402

Medison - 0164

Mega - 0054, 0391

Melectronic - 0165

Meta - 0305

Metronic - 0013, 0014, 0019, 0023,
0024, 0027, 0164, 0165, 0169, 0306,
0385, 0395, 0412, 0423

Metz - 0033, 0155, 0388

Micro Com - 0089

Micro electronic - 0158, 0161, 0164

Micro Technology - 0042, 0164, 0407

Micromaxx - 0010, 0028, 0059, 0062

Micronik - 0307

Microstar - 0028, 0059, 0062

Microtec - 0164

Minerva - 0033, 0159

Mitsubishi - 0020, 0033

Mitsumi - 0050

Mogen - 0308

Morgan Sydney - 0061

Morgan's - 0026, 0050, 0054, 0153,
0164, 0391, 0410, 0416

Motorola - 0167

Multichoice - 0168, 0175

Multiscan - 0309

Multistar - 0047, 0049

Multitec - 0154

Muratto - 0045, 0397

Mustek - 0310

Mysat - 0164

National Microtech - 0311

Navex - 0035, 0398

NEC - 0053, 0312, 0389

Nesco - 0313

Neta - 0314

Netgem - 0315

Network - 0390

Neuhaus - 0030, 0040, 0158, 0161,
0164, 0392, 0407, 0410, 0419

Neusat - 0164, 0419

Newave - 0316

NextWave - 0025, 0171, 0262

Nikko - 0026, 0164

Nokia - 0020, 0082, 0083, 0104, 0143,
0145, 0387, 0404, 0409, 0429

Nomex - 0063

Nordmende - 0019, 0020, 0021, 0024,
0060, 0234, 0398

Nova - 0168

2.1.3 Universal RC code list

19/26

Novis - 0035, 0398

Now - 0317

NTC - 0046

Numericable - 0380

Oceanic - 0039, 0042

Octagon - 0019, 0023, 0036, 0392,
0401, 0412

Okano - 0026, 0046, 0047

Ondigital - 0393

Optex - 0037, 0040

Optus - 0156, 0168, 0171

Orbit - 0031, 0381

Orbitech - 0019, 0154, 0156, 0158,
0408, 0410

Origo - 0042, 0157

Oritron - 0318

Osat - 0023, 0399

Otto Versand - 0033

Oxford - 0178

Pace - 0020, 0033, 0044, 0055, 0074,
0088, 0102, 0110, 0112, 0116, 0125,
0134, 0135, 0163, 0173, 0319, 0384,
0390, 0393, 0426

Pacific - 0039, 0320

Packsat - 0163

Pal - 0321

Palcom - 0021, 0029, 0043, 0234,
0322

Palladium - 0026, 0158, 0159

Palsat - 0154, 0158

Paltec - 0029

Panasat - 0168

Panasonic - 0020, 0055, 0074, 0078,
0142, 0426

Panda - 0020, 0155, 0161, 0384, 0387

Pansat - 0323

Pantech - 0324

Patriot - 0153, 0163

Philon - 0325

Phoenix - 0036, 0044, 0390, 0401

Phonotrend - 0020, 0023, 0040, 0046,
0395

Pioneer - 0087, 0156, 0326, 0427

Polsat - 0060

Polytron - 0037

Praxis - 0327

Predki - 0035, 0398

Preisner - 0153, 0328, 0403, 0410,
0416

Premiere - 0040, 0071, 0156, 0396,
0427

Priesner - 0026

Profi - 0051

2.1.3 Universal RC code list

20/26

Profile - 0163

Promax - 0020

Prosat - 0021, 0023, 0044, 0234, 0395, 0413

Prosonic - 0421

Protek - 0039, 0329

Provision - 0024

Pye - 0159

Pyxis - 0166

Quadral - 0010, 0021, 0023, 0028, 0163, 0173, 0234, 0395, 0402, 0410, 0413, 0420

Quelle - 0033, 0152, 0161, 0394

Quiero - 0060

Radiola - 0054, 0391

Radix - 0032, 0079, 0108, 0330, 0403, 0414

Rainbow - 0023, 0412, 0414

Rediffusion - 0053

Redpoint - 0030, 0407

RedStar - 0010, 0028, 0402

Regency - 0331

RFT - 0023, 0054, 0391, 0392, 0395, 0408

Roadstar - 0164

Roch - 0013

Rockdale - 0184

Rover 0010, 0164, 0413

Ruefach - 0051

Saba - 0024, 0042, 0056, 0152, 0161, 0163, 0169, 0390, 0418, 0419, 0420

Sabre - 0020

Sagem - 0005, 0060, 0146, 0332, 0424

Sakura - 0036, 0044, 0401

Salora - 0053, 0387

Samsung - 0017, 0018, 0019, 0076, 0081, 0096, 0137

Sansui - 0333

Sanyo - 0334

SAT - 0021, 0031, 0158, 0397, 0415

Sat Cruiser - 0171

Sat Partner - 0019, 0023, 0024, 0035, 0045, 0046, 0158, 0398

Sat Team - 0164

Satcom - 0034, 0160, 0161, 0400, 0411

SatConn - 0335

Satec - 0164, 0390

Satelco - 0010, 0402

Satford - 0034, 0400

Satline - 0413

Satmaster - 0034, 0400

2.1.3 Universal RC code list

21/26

Satplus - 0154

Satstar - 0336

Schacke - 0412

Schneider - 0028, 0059, 0062, 0154, 0163, 0422

Schwaiger - 0037, 0039, 0153, 0154, 0160, 0161, 0169, 0390, 0410, 0411

Scientific Atlanta - 0337

SCS - 0152

Sedeia Electronique - 0153, 0170

Seemann - 0026, 0030, 0032, 0402, 0407

SEG - 0010, 0019, 0028, 0035, 0160, 0398, 0402, 0411, 0421

Seleco - 0040, 0428

Septimo - 0169

Servi Sat - 0013, 0164

Setec - 0338

Sharp - 0115

Siemens - 0033, 0133, 0155, 0339, 0383, 0388, 0416

Silva - 0045

SilverCrest - 0340

Simz - 0341

Skantin - 0164

Skardin - 0030, 0407

Skinsat - 0158

SKR - 0164

SKT - 0342

SKY - 0084, 0167

Sky Digital - 0055

Sky New Zealand - 0343

Sky Television - 0344

Skymaster - 0003, 0004, 0023, 0138, 0139, 0154, 0160, 0164, 0395, 0411, 0413, 0430

Skymax - 0054, 0391

SkySat - 0154, 0158, 0160, 0161, 0164

Skyvision - 0040

SL - 0153, 0419

SM Electronic - 0154, 0164

Smart - 0108, 0152, 0153, 0164, 0345

Sogo - 0346

Sonaecom - 0347

Sony - 0055, 0156

SR - 0026, 0050, 0153

Star Clusters - 0348

Star Trak - 0349

Star View - 0350

Starland - 0164

Starring - 0035, 0398

Start Trak - 0019

2.1.3 Universal RC code list

22/26

Strong - 0010, 0019, 0023, 0028, 0045, 0168, 0170, 0271, 0402
STVI - 0013
Sumida - 0026
Sunny Sound - 0010, 0402
Sunsat - 0164, 0351, 0407
Sunstar - 0010, 0026, 0050, 0153, 0402
Sunstech - 0352
Super Sat - 0162
Super Track - 0353
SuperGuide - 0354
Supermax - 0171
SVA - 0355
Swisstec - 0303
Systec - 0153, 0356
S-ZWO - 0357
TaeKwang - 0358
Tandberg - 0060
Tandy - 0023
Tantec - 0020, 0043
Tatung - 0038
TBoston - 0359
TCM - 0028, 0059, 0062, 0379
Techniland - 0034, 0400
TechniSat - 0007, 0008, 0009, 0032, 0154, 0156, 0158, 0391, 0408
Technology - 0168
Technomate - 0277
Technosat - 0171
Technosonic - 0360
TechnoTrend - 0133
Technowelt - 0153, 0161, 0169
Teco - 0026, 0050
Tee-Comm - 0185
Telanor - 0021
Telasat - 0152, 0160, 0161, 0411
Teleciel - 0412
Telecom - 0164
Teledirekt - 0390
Telefunken - 0019, 0056, 0163, 0420
Teleka - 0023, 0026, 0032, 0158, 0161, 0403, 0406, 0412, 0419
Telemaster - 0024
Telemax - 0048
Telesat - 0160, 0161, 0411
Telestar - 0154, 0156, 0158
Teletech - 0430
Televés - 0020, 0061, 0153, 0158, 0345
Telewire - 0040
Tempo - 0171
Tevion - 0028, 0059, 0062, 0164

2.1.3 Universal RC code list

23/26

Thomson - 0006, 0020, 0057, 0060,
0103, 0106, 0117, 0141, 0150, 0151,
0152, 0156, 0161, 0163, 0164, 0396

Thorens - 0039, 0361

Thorn - 0020

Tioko - 0037, 0153

Tokai - 0391

Tonna - 0020, 0034, 0040, 0158, 0164,
0400

Topfield - 0126, 0362, 0382

Toshiba - 0363

TPS - 0058, 0364

Tratec - 0365

Triad - 0031, 0045, 0366, 0397

Triasat - 0158, 0405

Triax - 0033, 0056, 0152, 0153, 0158,
0164, 0405

Turnsat - 0164

Tvonics - 0114, 0367, 0368

Twinner - 0013, 0061, 0153, 0164

UEC - 0168, 0172

Uher - 0154

Uniden - 0415

Unisat - 0026, 0036, 0153, 0391, 0401

Unitor - 0027, 0035

Universum - 0033, 0152, 0155, 0159,
0161, 0388, 0404, 0415, 0421

Unnisat - 0369

Vantage - 0370

Variosat - 0033, 0155, 0388

Vector - 0042

Vega - 0010

Ventana - 0054, 0391

Vestel - 0421

Via Digital - 0057

Viasat - 0173, 0371

Viewstar - 0372

Vision - 0373

Visionic - 0170

Visiosat - 0035, 0040, 0163, 0164,
0418

Viva - 0392

Vivanco - 0064

Vivid - 0172

Vortec - 0019, 0374, 0393

VTech - 0031, 0165, 0397, 0418, 0423

Watson - 0375

Wela - 0410

Welltech - 0154

WeTeKom - 0154, 0158, 0160

Wevasat - 0020

2.1.3 Universal RC code list

24/26

Wewa - 0020

Winersat - 0035, 0398

Wintergarten - 0395

Wisi - 0020, 0031, 0032, 0033, 0155,
0158, 0161, 0388, 0397, 0403, 0410,
0418

Woorisat - 0024

World - 0398

Worldsat - 0163, 0376

Xcom Multimedia - 0186

Xoro - 0377

Xrypton - 0010, 0402

XSat - 0164, 0173

Zaunkonig - 0419

Zehnder - 0010, 0024, 0027, 0028,
0047, 0105, 0107, 0152, 0165, 0397,
0402, 0421, 0423

Zenith - 0167

Zinwell - 0071

Zodiac - 0023, 0412

Zwergnase - 0026

-->HTS

Home Theatre System

Amplifier

HTS codes

Philips - 0000, 0001, 0002, 0003, 0009,
0011, 0022, 0029, 0030, 0031, 0032,
0039, 0044, 0046, 0118, 0119, 0120,
0130, 0131, 0132, 0133, 0137, 0144,
0145, 0146, 0147, 0148, 0189, 0219,
0220

Aiwa - 0006, 0025, 0160, 0161, 0221,
0222, 0227, 0247, 0248

Akai - 0259, 0260

-->

Alba - 0171

AMW - 0069

Andersson - 0070

Basic Line - 0071

BOSE - 0067, 0068, 0072, 0073, 0074,
0075, 0076, 0077

Bush - 0051, 0261, 0262, 0263

Celestron - 0078

Centrum - 0079

Clatronic - 0080

Daewoo - 0060

Daytek - 0081

Denon - 0126, 0127, 0128, 0129, 0138,
0139, 0264, 0265, 0266

Denver - 0156, 0157, 0176, 0177

Digix Media - 0082

DK Digital - 0007

Dmtech - 0083

2.1.3 Universal RC code list

25/26

Dual - 0084

Eltax - 0004, 0081

Euroline - 0085

Finlux - 0086

Fintec - 0087

Futronic - 0088

Goodmans - 0174, 0175, 0267, 0268

Harman/Kardon - 0064

Hitachi - 0024, 0166, 0167, 0168

Hyundai - 0089

Infotech - 0090

Jamo - 0091

JBL - 0092

JVC - 0008, 0016, 0020, 0050, 0123,
0124, 0125, 0187, 0188, 0190, 0191,
0209, 0210, 0223, 0224, 0225, 0236

KEF - 0093

Kenwood - 0019, 0094, 0164, 0165,
0213, 0214, 0243, 0244, 0249, 0250,
0251

Lennox - 0095

LG - 0026, 0041, 0042, 0043, 0048,
0049, 0062, 0065, 0169, 0170, 0178,
0179, 0180, 0181

Linn - 0096

Loewe - 0097

Lumatron - 0098

Magnavox - 0011, 0118, 0132

Medion - 0099

MiCO - 0100

Mivoc - 0101

Mustek - 0013

NAD - 0102

Nakamichi - 0103

Palladium - 0104

Panasonic - 0005, 0010, 0012, 0020,
0021, 0033, 0034, 0035, 0036, 0037,
0053, 0054, 0063, 0141, 0142, 0143,
0217, 0218, 0228, 0229, 0240, 0241

peeKTON - 0105

Pioneer - 0027, 0045, 0047, 0153,
0154, 0155, 0200, 0201, 0256

Redstar - 0106

Saba - 0172, 0173

Samsung - 0018, 0056, 0057, 0061,
0158, 0159

Sansui - 0085

Sanyo - 0015, 0017, 0149, 0150, 0151,
0246

Sharp - 0134, 0135, 0136, 0194, 0195,
0196, 0213, 0214, 0234, 0235

2.1.3 Universal RC code list

26/26

Sony - 0006, 0014, 0023, 0038, 0040,
0113, 0114, 0115, 0116, 0117, 0152,
0182, 0183, 0184, 0185, 0186, 0197,
0202, 0203, 0204, 0205, 0206, 0207,
0208, 0215, 0216, 0230, 0237, 0238,
0239, 0242, 0245, 0253, 0254, 0255

T+A - 0107

TCM - 0111, 0273, 0274, 0275, 0276

Teac - 0108, 0121, 0122, 0269, 0270,
0271, 0272

Technics - 0005, 0020, 0112, 0140,
0142, 0211, 0212, 0226

Thomson - 0055, 0059, 0152, 0192,
0193, 0197, 0198, 0199, 0231, 0232,
0233, 0252

Toshiba - 0058

Union - 0066

Universum - 0109

Xoro - 0110

Yamaha - 0028, 0052, 0162, 0163,
0257, 0258

2.1.4 Batteries

Open the battery cover on the back of the remote control to insert the 3 batteries supplied (Type AAA-LR03-1.5V).

Make sure the + and - ends of the batteries line up correctly (+ and - are marked inside).

Remove the batteries if you are not using the remote control for a long time.

Dispose of batteries according to the end of use directives. Read Get started > Important > End of use.

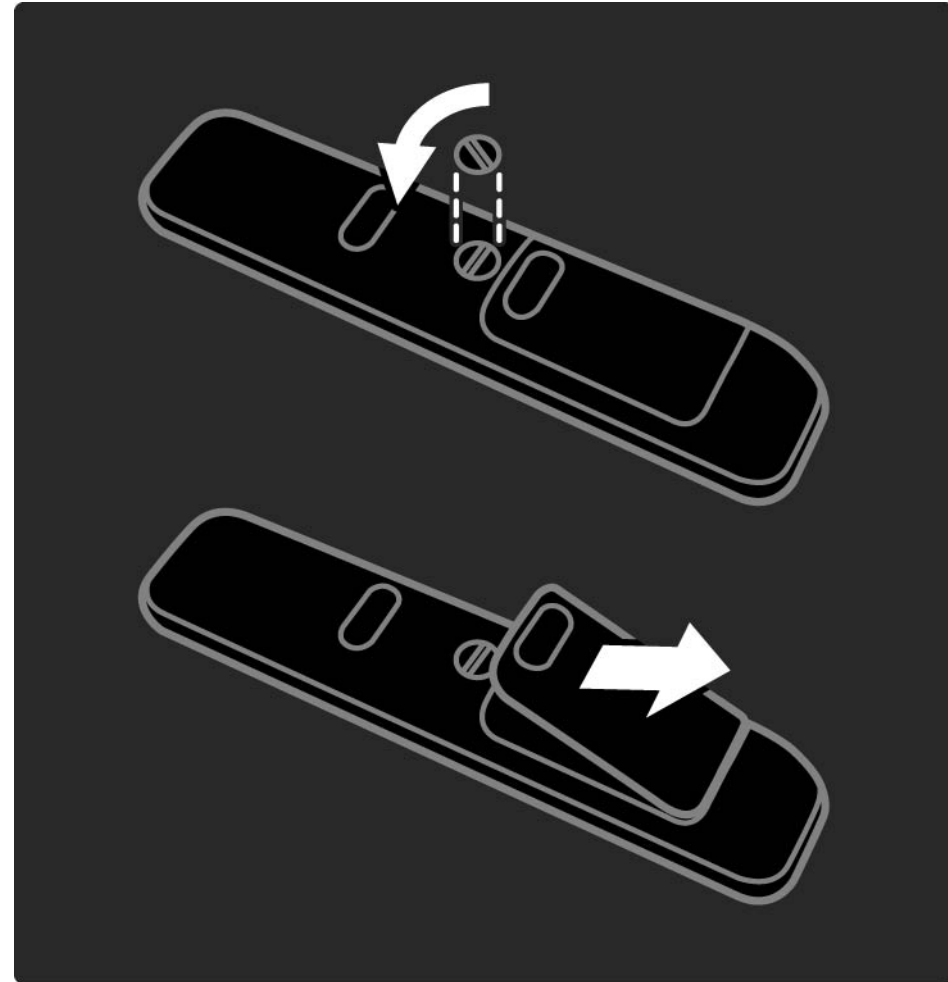

2.2.1 Channel overview

1/5

While watching TV, press OK to open the Channel overview. This overview shows the TV channels and possible radio stations installed on your TV.

Navigate to a channel or station with the ▲ or ▼, ◀ or ▶ keys. Press OK to watch or listen to the selected channel or station.

Press Back ↶ to leave the channel overview without changing the channel.

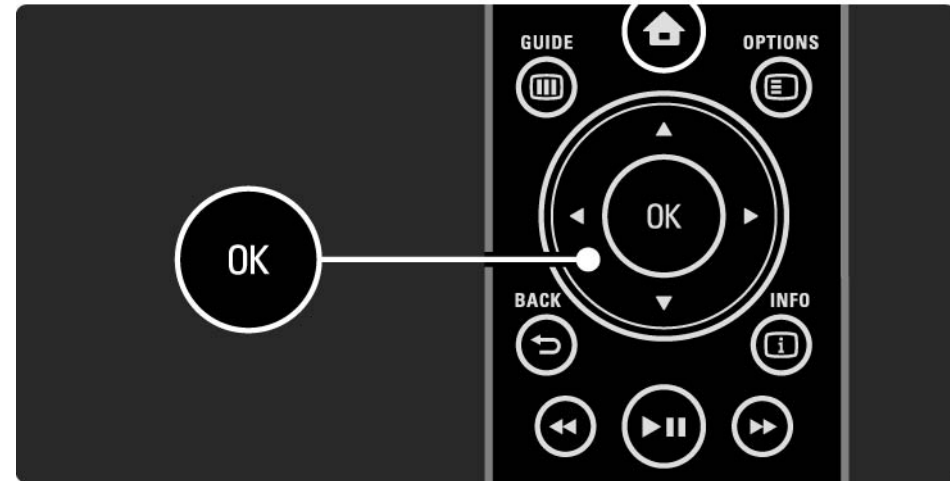

2.2.1 Channel overview

2/5

With the Channel overview on screen you can press Options  to access the following functions:

Select list

Select which channels are shown in the Channel overview. When a filter is set in the Channel overview, press P+/- to go through the channels of the filtered overview, while watching TV.

Mark as favourite

When a channel is highlighted in the Channel overview, you can set it as a favourite channel.

Read More on ... > Favourite channels.

...

2.2.1 Channel overview

3/5

Reorder

You can reposition channels within the overview.

1 Select Reorder in the Options  menu to start reordering channels.

2 Highlight a channel and press OK.

...

3 Reposition the channel where you want it with the navigation keys.

4 Press OK to confirm the position.

You can highlight another channel and do the same.



To stop Reorder, press Options  and select Exit reorder.

...

2.2.1 Channel overview

Rename

You can rename a channel.

- 1 In the channel overview, navigate to the channel you want to rename.
- 2 Select Rename in the Options  menu.
- 3 Use the navigation keys to position the highlight. Press Back  to delete a character. Use the remote control number pad as you do for SMS/text messaging to select a character. Use the 0 number key to select a special character. Select Clear to clear all text.
- 4 Select Done and press OK to end Rename.

Hide channel

Select this option when you want to hide a channel in the Channel overview. When you hide a channel, it will be hidden next time you open the Channel overview.

To unhide hidden channels select the Show hidden channels from the Options  menu.

...

2.2.1 Channel overview

5/5

Show hidden channels

You can show all channels, including all hidden channels. You can unhide or hide channels.

1 Select Show hidden channels from the Options  menu.

2 Navigate to a channel.

3 Press Options  and select Hide or Unhide channel.

You can navigate to another channel and do the same.

To exit the Show hidden channels view, select Exit hidden channels in the Options menu. The overview is adapted the next time you open it.

2.2.2 Home🏠

The Home menu lists the activities you can do with your TV.

Press 🏠 to open the Home menu.

To start an activity, highlight the desired item with the navigation keys and press OK.

You can add an activity, always linked to a device, with the Add your devices item.

To exit the Home menu, press 🏠 again.



2.2.3 Add your devices

When you have connected a device to the TV, always add this device as an item in the Home menu. With this item in the Home menu, you can easily switch the TV to this device.

In the Home menu, select Add your devices and press OK. Follow the instructions on screen.

The TV asks you to select the device and the connector to which the device is connected.

From now on, this device is added to the Home menu.

To remove a device item from the Home menu, select the item, press Options  and select Remove device in the list. Press OK.

2.2.4 Setup

The Setup item in the Home menu holds most TV settings.

In the Setup menu you can ...

- set picture, sound or Ambilight settings
- set some special features
- update or re-install TV channels
- connect to a network
- update the TV software
- ...

In the Home menu, select Setup and press OK.

Select an item with the ◀ or ▶, ▲ or ▼ keys and press OK.

To exit the Setup menu, press Back ↵.

2.2.5 Options

The Options menu offers convenient settings related to what is on screen.

Press Options  in any circumstance to see which options are available.

To exit, press Options  again.



2.2.6 Guide

1/2

You can view a list of scheduled TV programmes with the Guide menu (only for digital broadcast). Also, use the Guide key to view the list of your photos, music or videos from a connected PC network or USB memory device.

While watching TV, press Guide  to open the Programme guide, if this information is available.

...



2.2.6 Guide

2/2

When browsing your PC network or a USB memory device, press Guide  to show the content.

Read More on ... > Programme guide or More on ... > Multimedia.

2.3.1 Switch channels

To switch TV channels, press P + or — on the remote control. You can use the number keys if you know the channel number.

To switch back to the previous viewed channel, press Back ↵.

If digital broadcasting is available, digital radio stations are installed during installation. Switch to a radio channel as you would do for TV channels. Radio stations usually start from channel number 400 onwards.

Channel overview

While watching TV, press OK to open the Channel overview. Select the channel with the navigation keys and press OK to switch to the channel.

To leave the channel overview without changing the channel, press Back ↵.

2.3.2 Programme info

When watching a digital TV channel, information on the current and next programme is available.

While watching TV, press Info  to open the programme information on the channel you are watching.

To close the programme information, press Info  again.

Options 

When the programme information is on screen, press Options  to access information on the quality of the digital channel you are watching.

2.3.3 Switch to standby

If the TV is on, press  on the remote control to switch to standby.

The red standby key indicator is on.

Although the TV consumes very little power when in standby, energy continues to be consumed.

When the TV is not in use for an extended period of time, we advise to switch the TV off with the  key on the TV and to unplug the TV mains cord from the mains outlet.

If you can not locate your remote control and you want to switch the TV to Standby, press  on the side of the TV. This switches off your TV.

To switch the TV back on, press  again.

2.3.4 Smart Settings

You can set the TV to the predefined setting that is best for what you're watching at the moment. Each setting combines picture, sound and Ambilight.

While watching TV, press Options  and select Picture and sound. Press OK.

Select Smart settings and press OK.

Select a setting from the list and press OK.

- **Personal** — Sets the TV to your personal preferences set in the Picture, Sound and Ambilight menus in the Setup menu.
- **Vivid** — Rich and dynamic settings, ideal for daylight use.
- **Natural** — A natural picture setting.
- **Cinema** — Ideal settings for watching movies.
- **Game** — Ideal settings for gaming.
- **Standard** — The factory standard and most energy conscious settings.

2.3.5 Picture format

1/2

If black bars appear in the screen, adjust the picture format. Ideally change the picture format to a format that fills the screen.

While watching TV, press Format **[F]** to switch on the Picture format menu, select an available picture format and press OK.

If subtitles are hidden in a programme, press **▲** to shift the picture upwards.

You can select the following picture format settings ...

Auto format

Enlarges the picture automatically to fill the screen. Minimal picture distortion, subtitles remain visible. Not fit for PC.

In the Setup > Picture > Auto format mode menu you can select 2 Auto format settings ...

- Auto-fill, to fill the screen as much as possible.
- Autozoom, to keep the original picture format, black bars may be visible.

...

2.3.5 Picture format

2/2

Super zoom

Removes the black bars on the side of 4:3 broadcasts. The picture is adjusted to fit the screen.

4:3 format

Displays programme in the 4:3 format.

Movie expand 16:9

Scales the format to 16:9.

Wide screen

Stretches the format to 16:9.

Unscaled

Maximum sharpness. Distortion may appear on borders. Black bars may appear with pictures from your PC. Only for HD and PC.

2.4.1 Ambilight on

With Ambilight, you will enjoy a more relaxed viewing experience and improved perceived picture quality.

Dim the lighting conditions in the room for the best Ambilight effect.

To switch Ambilight on or off, press Ambilight on the remote control.

Caution

To avoid bad infrared remote control reception, place your devices out of sight of Ambilight.

Dynamic speed

To adjust the speed at which Ambilight responds to the onscreen images, press Ambilight for 3 seconds.

Adjust the dynamic speed with the onscreen slider bar. Relaxed sets Ambilight to change softly and smoothly. Dynamic sets Ambilight to change quickly and is more responsive.

To change the dynamic speed, Active mode needs to be set to a value greater than zero. Close this user manual and press  > Setup > Ambilight > Active mode.

2.4.2 Ambilight settings

In the Ambilight menu you can set or adjust the following Ambilight settings ...

While watching TV, press  > Setup > Ambilight.

Ambilight

Switches Ambilight on or off.

Active mode

Adjusts the speed at which Ambilight responds to the onscreen images.

Brightness

Changes the light output of Ambilight.

Colour

Sets the Ambilight colour to either dynamic behaviour (Active mode) or one of the predefined Ambilight constant colours.

Custom allows fine tuning of a constant colour.

Custom colour

To set a Custom colour select Custom in Colour.

Separation

Sets the difference in colour level between the lights at each side of the TV.

Separation off gives a dynamic but uniform Ambilight colour.

2.4.3 LoungeLight

When the TV is on standby, you can switch Ambilight on and create an Ambilight LoungeLight effect in your room.

To switch Ambilight on while the TV is on standby, press Ambilight on the remote control.

To change the LoungeLight colour scheme, press Ambilight for 3 seconds.

2.5 Watch a DVD movie

To watch a DVD movie using your DVD player, switch on your DVD player, insert a disc and press Play on the player. The DVD picture automatically appears on the screen.

If the DVD picture does not appear, press  on the remote control and select DVD player. Press OK.

Wait a few seconds until the DVD picture appears.

If the DVD player is not yet in the Home menu, read Use your TV > Menus > Add your devices.

2.6 Watch TV using a digital receiver

When you watch TV using a digital receiver, with a subscription from a cable or satellite company, connect the receiver and add the receiver to the Home menu.

To add the receiver to the Home menu, read Use your TV > Menus > Add your devices.

To watch the receiver programme, switch on the receiver. If the receiver programme does not appear automatically, press  and select the receiver item in the Home menu. Press OK.

Use the remote control of the digital receiver to select TV channels.

2.7 Watch TV from a connected device

When you have added a connected device as an item to the Home menu, you can easily and directly select that device to watch its programme.

To add the device to the Home menu, read Use your TV > Menus > Add your devices.

To watch TV from a connected device, press  and select the device item in the Home menu. Press OK.

If the connected device is not in the Home menu, select the device from the Source menu.

Press  Source on the remote control, or at the side of the TV, to show the source list.

Select the device or its connector and press OK.

2.8.1 Net TV benefits

Net TV offers Internet services and websites tailored for your TV. Use the TV remote control to browse the Net TV Internet pages. You can play movies, view pictures or listen to music, consult infotainment, play games and much more, all set up for your TV screen.

Specifics

- Because Net TV is an online system, it can be modified over time to better serve its purpose.
- Some Net TV services can be added, changed or stopped after some time.
- Net TV shows pages full screen and 1 page at a time.
- You cannot download and save files nor install plug-ins.

2.8.2 What you need

To enjoy Net TV, you need to connect the TV to a router with a high speed connection to the Internet.

Read the chapter Setup > Network.

Once the connection is made, select Net TV in the Home menu to start the Net TV onscreen setup.

Read the chapter Net TV > First use.

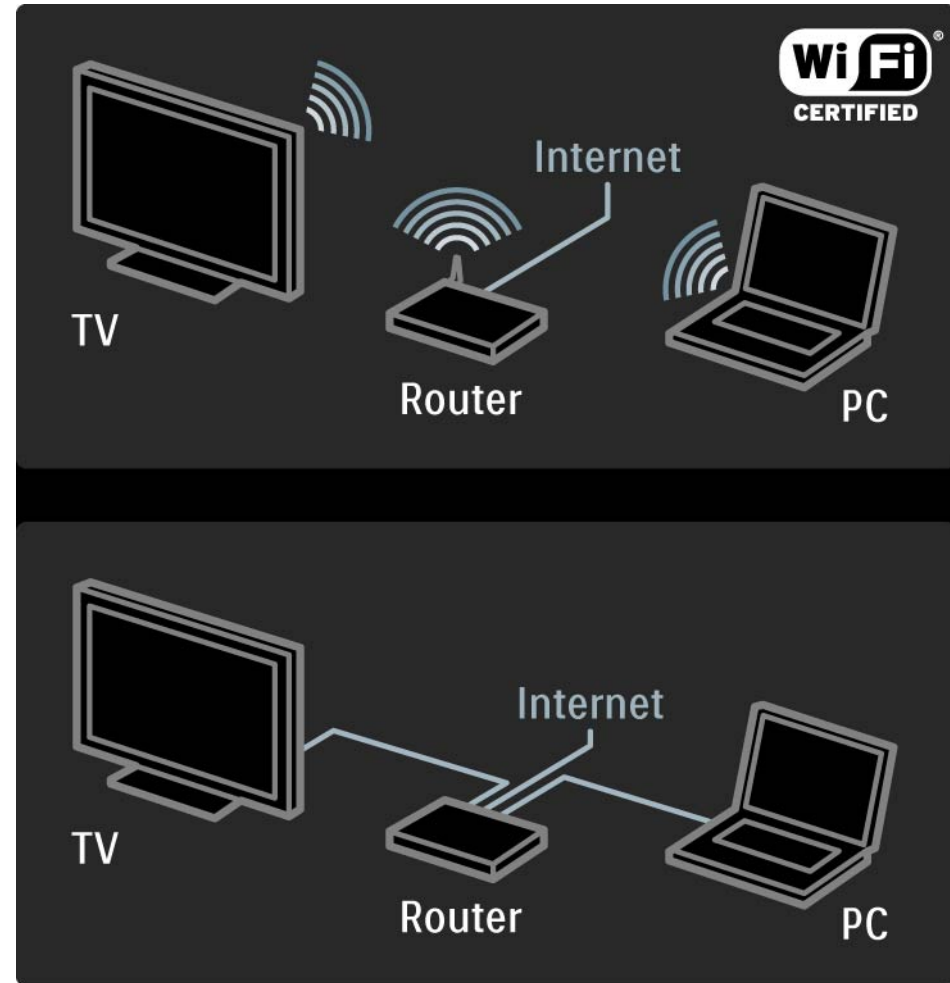

2.8.3 First use

1/3

The first time you link up to Net TV, the TV asks you to agree on the Terms of Use. When you agree on these terms, the TV asks you to register for Net TV. After registration, you can switch on the Parental control setting.

Registration benefits

When you have registered for Net TV, the pages you select as favourite pages or as locked pages are stored as back-up. Also, the last 16 web addresses (URLs) you visited are stored. You can share these same selections with another Net TV television if you register that TV with the same email address. When registered, you can restore these same selections after an accidental reset of Net TV with Clear history.

2.8.3 First use

2/3

How to register

To register, you need an email address and a PC connected to the Internet. If you skip the registration at first use, you can register from the Net TV start page later on.

To start the Net TV registration, you need to enter your email address on the TV screen. Use the keypad on the remote control as you do for SMS/text messaging to enter the address. Select Register and press OK.

A message will show if a registration email has been send to your email address. Open the email on your PC and click the link to the registration form. Complete the form and click the button to submit.

On the TV, select OK and press OK to open the Net TV start page.

...

2.8.3 First use

3/3

Parental control benefits

With Parental control switched on ...

- you can lock and unlock services and/or categories of services
- some services unsuitable for children are locked from the start but can be unlocked

Specifics

- Only services on the Net TV pages can be locked. Advertisements and open Internet websites can not be locked.
- Services are locked per country. Categories are locked for all countries.

Switch on Parental control

The first time you open the Net TV start page, the TV asks you to switch on the Parental control. If you switch on Parental control, the TV asks you to enter a personal lock/unlock code. Enter a 4 digit code as Net TV lock/unlock code. Use the number keys on the remote control. Enter the same code again to confirm.

Net TV is ready to use.

2.8.4 Browse Net TV

To browse Net TV, close this user manual and press Net TV on the remote control or select Browse Net TV in the Home menu and press OK. The TV links up to Net TV and opens the start page.

To exit Net TV, press Net TV again or press , and select another activity.

...

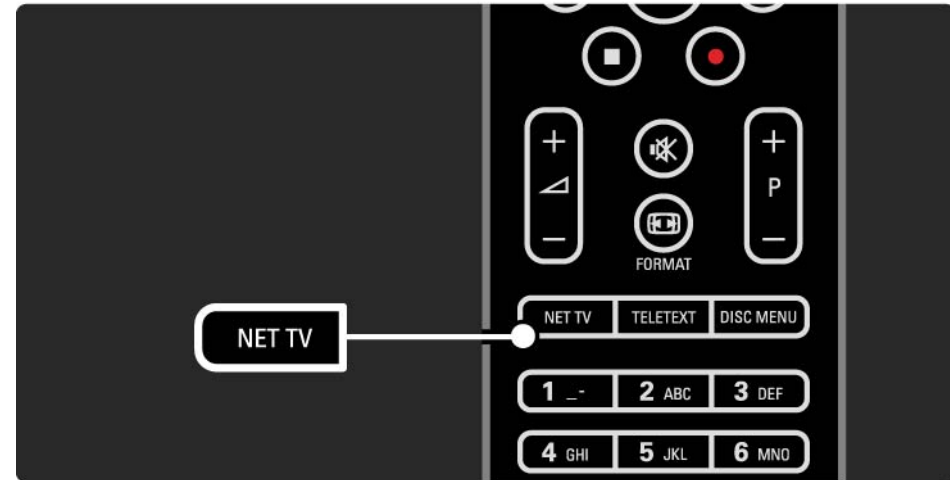

2.8.4 Browse Net TV

2/6

The Net TV start page

The Net TV start page shows your favourite services and some recommended services. You can browse Net TV from this page.

Select a Net TV service with ▲ or ▼, ◀ or ▶ keys. To open a service, press OK.

Press Back ↵ to go back one page.

Press Net TV to return to the Net TV start page.

The Browse all page

The Browse all page holds all services.

On the Browse all page, you can view the Net TV services by category. Select a category and press OK.

Browse another country

On the Browse all page you can switch the Net TV country. Another country might have different services.

Select Browse: ..., select another country and press OK.

...

2.8.4 Browse Net TV

3/6

Mark favourites

You can mark up to 12 favourite services.

To mark a service as a favourite, select the service icon and press Options . Select Mark favourite and press OK.

All your favourite services are shown in the Net TV start page. In the Browse all page favourite services are marked with a star ★.

Use the Options menu to unmark.

To mark several services as favourites in one go, select Mark favourites on the Net TV start page or Browse all page and press OK. Now you can select services and mark them one by one, with OK. You can switch to the Browse all page if necessary. To end the Mark favourites mode, select Done and press OK.

Only Net TV services can be marked as favourite. Advertisements and open Internet websites can not be marked.

...

2.8.4 Browse Net TV

4/6

Open Internet websites

With Net TV you can link up to the open Internet. You can view any website you like but remember that most open Internet websites are not tailored to be viewed on a TV screen and certain necessary plug-ins (e.g. to view pages or videos) are not available on your TV.

Enter open Internet

On the Browse all page, select Browse Internet and press OK. On the onscreen keyboard you can enter the web address you like. Select a character and press OK to enter the address.

Use the ▲ or ▼, ◀ or ▶ keys to navigate to the available links on a open Internet page, press OK to go to the link.

...

2.8.4 Browse Net TV

5/6

Scrolling open Internet pages

Use the P - and + to scroll pages up or down.

Zoom open Internet pages

You can zoom open Internet in or out. Press Format .

Use the arrows up or down to zoom in or out.

...

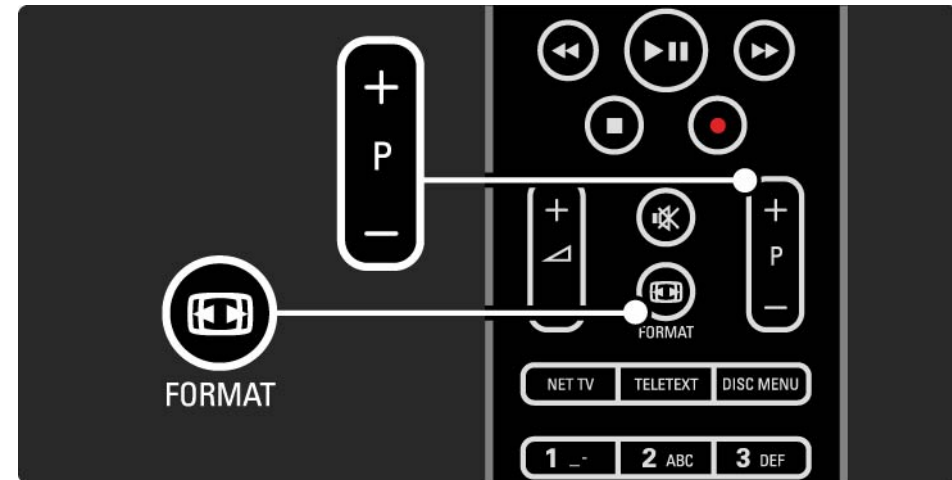

2.8.4 Browse Net TV

6/6

Clear history

You can clear the Net TV memory.

To clear the Parental control code, passwords, cookies and history, press  > Setup > Installation > Clear Net TV memory.

Koninklijke Philips Electronics N.V. bears no responsibility regarding the content and the quality of the content provided by the content service providers.

2.8.5 Net TV - TV guide

The moment you link up with Net TV, the TV programme guide information comes from the Internet. However, you can switch back to programme guide information from the digital broadcaster.

Close this user manual and press  > Setup > Installation > Preferences > Programme guide and select From broadcaster.

In both cases, Philips is not responsible for the programme guide information.

2.8.6 Parental control

1/3

With Net TV Parental control you can lock Net TV services and service categories. When a service is locked, you need to enter a code to open the service or category.

To lock a service, Parental control needs to be switched on. Parental control is switched on when a lock icon appears when you link up with Net TV.

Switch on Parental control

If you did not switch on Parental control yet, close this user manual and press Net TV. When the Net TV start page is onscreen, press Options  and select Enable parental control. The TV asks you to enter a personal lock/unlock code. Enter a 4 digit code as lock/unlock code. Use the number keys on the remote control. Enter the same code again to confirm.

...

2.8.6 Parental control

2/3

Lock a service or category

On the Net TV start page or Browse all page, select a service or category. Press Options , select Lock service and press OK. The service is locked when a lock symbol appears on top of the service icon.

Unlock

To unlock a service or category, select the service and press Options  and select Remove lock.

Specifics

- Only services on the Net TV pages can be locked. Advertisements and open Internet websites can not be locked.
- Services are locked per country. Categories are locked for all countries.
- The Net TV Parental control code and the Child lock code of the TV are 2 different codes.
- When you have registered Net TV and you switch off Parental control in the Options menu, all locks are remembered and available again when you switch Parental control back on.

...

2.8.6 Parental control

3/3

Did you forget your code ?

If you forgot your Parental control code, you can clear the Net TV memory and enter a new code.

Read the chapter Use your TV > Net TV > Clear history.

2.8.7 Clear history

Warning

If you clear the Net TV memory with Clear history, you need to redo the first use registration when you link up to Net TV again. If you have registered before, you can restore your former favourite services and former locks.

Clear history

You can clear the Net TV memory.

To clear the Parental control code, passwords, cookies and history, press  > Setup > Installation > Clear Net TV memory.

3.1.1 Select a teletext page

Most TV channels broadcast information through teletext.

While watching TV, press Teletext.

To exit teletext, press Teletext again.

To select a page ...

- Enter the page number with the number keys.
- Press P +/- or ▲ or ▼ or ↵ to view the next or the previous page.
- Press a colour key to select a colour-coded item at the bottom of the screen.

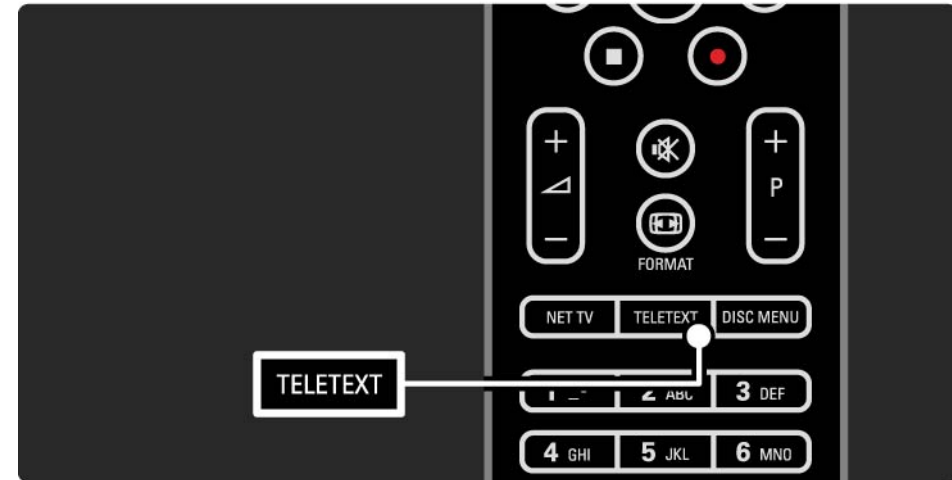

3.1.2 Select a teletext language

Some digital TV broadcasters have several teletext languages available. You can set your primary and secondary language.

Press  > Set up > Installation > Languages > Primary or Secondary teletext and select your preferred teletext languages.

3.1.3 Select teletext subpages

A teletext page number can hold several subpages.

The pages are shown on a bar next to the main page number.

Use ◀ or ▶ to select the subpages when they are available on a teletext page.

3.1.4 Select T.O.P. teletext

You can easily jump from one subject to another without using page numbers with T.O.P. teletext.

Not all channels broadcast T.O.P. teletext.

Press Info  when teletext is switched on.

The T.O.P. overview appears.

Select a subject and press OK to view the page.



3.1.5 Search teletext

In teletext, you can quickly jump to a subject linked to a series of page numbers. Also, you can search for specific words in teletext pages.

Switch on teletext and press OK. The first word or first index number of the page is highlighted onscreen.

Jump to the next word or number on the page with ◀ or ▶, ▲ or ▼.

Press OK to search for a page featuring the highlighted word or number.

Each time you press OK, the next page featuring the highlighted word or number is shown.

To exit Search, press ▲ until no word or number is highlighted.

3.1.6 Teletext options

1/2

When in teletext, press Options  on the remote control to reveal hidden info, let subpages cycle automatically, change the character setting, freeze a teletext page, view the TV channel and teletext simultaneously or show a teletext page full screen again.

Freeze page

Stop the automatic rotation of subpages or stop the page counter when you have entered a wrong page number or when the page is not available.

Dual screen / Full screen

Not available for channels with Digital Text services.

Select Dual screen to view the TV channel and teletext alongside each other.

Select the option Full screen to show full screen teletext again.

Reveal

Hide or unhide hidden information on a page, such as solutions to riddles or puzzles.

...

3.1.6 Teletext options

Cycle subpages

If subpages are available for the selected page, you can make subpages cycle automatically.

Language

Some languages use a different set of characters. Switch to the other character group to show the text correctly.

Enlarge teletext page

You can enlarge the teletext page for more comfortable reading.

In teletext, press **[F4]** to enlarge the top part of the page and **[F5]** again to view the enlarged lower part of the page. With **▲** or **▼** you can scroll through the enlarged page.

Press **[F4]** again to return to the normal page size.

3.1.7 Digital text (UK only)

Some digital TV broadcasters offer dedicated digital text or interactive services on their digital TV channels, for example BBC1. These services include normal teletext with the number, colour and navigation keys to select and navigate.

While watching TV, press Teletext and navigate to select or highlight items.

Use the colour keys to select an option and press OK to confirm or activate.

Press ■ to cancel Digital text or interactive services.

Digital text services are blocked when subtitles are broadcast and Subtitle On is set in the Features menu.

Read Subtitles and languages > Subtitles.

3.1.8 Teletext 2.5

Teletext 2.5 offers more colours and better graphics, if broadcast by the TV channel.

Teletext 2.5 is activated as a standard factory setting.

To switch it off select  > Setup > Installation > Preferences > Teletext 2.5.

3.2 Favourite channels

After you have finished the installation, all TV and radio channels are added to the Channel overview.

In this overview, you can mark channels as favourites and set the Channel overview to only show these favourites.

While watching TV, press OK to open the Channel overview. With a channel highlighted, press Options . Select Mark as favourite to make the highlighted channel a favourite channel. Favourite channels are marked with a ★. Unmark the channel as favourite with Unmark favourite.

Select list

With the Select list option in the Channel overview, you can set the overview to show only your favourite channels.

Read Use your TV > Menus > Channel overview.

3.3.1 Programme guide

1/3

The Programme guide is an onscreen guide of scheduled TV programmes. This guide is provided by the broadcasters or Net TV. You can set a reminder to show a message when a programme starts or select programmes by genre.

While watching TV, press Guide  to open the Programme guide. If available, a list of the current TV programmes appears. It may take some time to load this information.

To exit the Programme guide, press Guide .



...

3.3.1 Programme guide

2/3

Navigate through the list to select a programme.

Info 

To open the programme details and summary, press Info .

To show a message onscreen when the programme starts, select Set reminder and press OK. The programme is marked with . To cancel the message, select Clear reminder and press OK. To switch to the TV channel of the programme directly, select Watch channel and press OK.

Options 

In the Programme guide list, press Options  to select the following ...

- Set reminder

If a reminder is set, the option Scheduled reminders is available with a list of all reminders.

- Change day

View the previous or next day's programmes.

- More info

Opens the info screen with details and a summary of the programme.

...

3.3.1 Programme guide

3/3

- Search by genre

View all programmes by genre. Select a programme and press Info ⓘ for more info or to set a reminder.

- List of preferred programmes

Set channels to appear in the Programme guide list (max. 50 channels).

Specifics

If the Programme guide information comes from a broadcaster/operator, the first 40 channels out of the channel overview are shown in the Programme guide. You can add 10 other channels yourself.

Some broadcasters/operators can show the first 170 channels and you can add another 10 channels. In this case, the Programme guide schedules all programmes for today and the next 3 days.

3.3.2 Setup

To select where the Programme guide information comes from, press **🏠** > Setup > Installation > Preferences > Programme guide.

From network

Until you link up with NetTV, guide information comes from the broadcaster. From network will switch to the Internet for guide information as soon as the TV is connected to Net TV.

From broadcaster

Guide information comes from the broadcaster/operator.

3.4.1 Sleptimer

With Sleptimer you can switch the TV to standby or out of standby at a specified time.

Close the user manual and press  > Setup > Features > Sleptimer.

With the Sleptimer slider bar you can set the time up to 180 minutes in steps of 5 minutes.

If set to 0 minutes, Sleptimer is switched off.

You can always switch off your TV earlier or reset the time during countdown.

3.4.2 Child lock

1/2

To prevent children from watching TV, you can lock the TV or block age rated programmes.

Set your personal code

Before you set Child lock to lock the TV or set an age rating, set your personal lock code in **🏠 > Setup > Features > Set code**.

Enter the four-number code with the number keys.

You can always change the code if necessary.

Child lock

Select Lock as Child lock setting, to lock all TV channels and the programmes from devices.

When Lock is set, you need to enter your personal code to unlock the TV.

The lock is activated the moment you close the menu on screen or set the TV in standby.

...

3.4.2 Child lock

2/2

Parental rating

Select Parental rating as Child lock setting, so that an age can be set in the Parental rating age list. Set the age of your child. Programmes with an equal or higher rating will be blocked.

To set an age rating in this list, read [More on ... > Timers and locks > Age rating](#).

Forgotten your code?

If you have forgotten your unlock code, call Philips Consumer Care in your country. Find the telephone number on the documentation that came with the TV or go to www.philips.com/support

Press  > Setup > Features > Change code and enter the overriding code you received from Consumer Care. Enter a new personal code and confirm. The previous code is erased and the new code is stored.

3.4.3 Age rating

Some digital broadcasters, depending on your country, have their programmes rated. When the rating is equal to or higher than the rating you have set for your child's age, the programme will be blocked.

To set an age rating, press  > Setup > Features > Child lock and select Custom lock.

With Custom lock selected in Child lock, go to  > Setup > Features > Parental rating and select the age rating for programmes that are allowed to be viewed.

A programme with an equal or higher age rating will be blocked and the TV will ask for the code to unblock the programme. Some operators only block programmes with a higher rating.

Age rating is activated the moment you close the onscreen menu or set the TV to standby.

Read More on ... > Timers and locks > Child lock.

3.5.1 Subtitles

1/3

Programme subtitles are available most of the time. You can set subtitles to display constantly. Depending on the channel, an analogue or digital channel, a different method is used to set constant subtitles.

For digital channels, a preferred subtitle language can be set.

For analogue channels

To have subtitles constantly onscreen, select an analogue TV channel and press Teletext to switch on teletext.

Enter the three number page number of the subtitles page, usually 888, and press Teletext again to switch off teletext. Subtitles will show if available.

Each analogue channel needs to be set separately.

...

3.5.1 Subtitles

2/3

Subtitle menu

To switch subtitles on constantly, press Subtitle.

Select Off, On or On during mute.

With On during mute, the TV displays subtitles only when the sound is muted with .

...

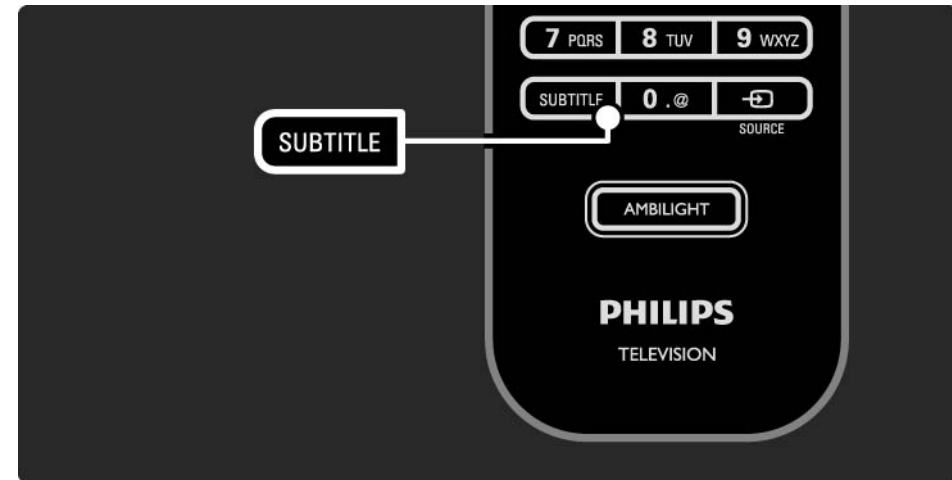

3.5.1 Subtitles

3/3

Digital channel subtitle languages

If subtitles are available on digital channels, you can select a preferred subtitle language from a list of broadcast languages.

See  > Setup > Features > Subtitle language.

Select a subtitle language from the list of available languages and press OK.

The preferred subtitle languages set in the Installation menu are overruled temporarily.

3.5.2 Audio languages

Digital TV channels can broadcast several audio languages that go with the programme. You can set your preferred languages to switch to when these audio languages are broadcast.

To set your preferred audio languages, press  > Setup > Installation > Languages > Primary language. You can also set a secondary language in the same Languages menu.

The TV will automatically switch to the languages you set, if the language is broadcast.

To check if an audio language is available, press Options  and select Audio language. You can select another audio language from the list.

Some digital TV channels broadcast special audio and subtitles adapted for people that are hearing or visually impaired. Read More on ... > Universal access.

3.6.1 Browse USB

1/2

Watch photos or play music and videos on TV from a USB memory device.

Insert a USB device in the USB connector on the left hand side of the TV while the TV is switched on.

The TV detects the device and opens a list showing the content of the USB device onscreen.

If the content does not show, press  > Browse USB and press OK.

While the USB content list is open onscreen, select the file you want to play and press OK or play .

A song, a slideshow of photos or a video starts playing.

To pause, press  again.

To jump to the next file, press  or P +.

To jump to the previous file, press  or P -.

To fast forward a music file, press .

Press Options  to Play once, Repeat, Shuffle, Rotate and much more.

...

3.6.1 Browse USB

2/2

Watch videos

Select a video in the Guide menu and press play ▶||.

To pause the video, press pause ▶||.

To fast forward, press ▶▶ once to go slow, press twice to go fast. Press again for normal speed.

Press Options  to change to Full screen, Small screen, Play once, etc.

To exit Browse USB, press  and select another activity or disconnect the USB memory device.

3.6.2 Browse PC Network

1/2

Watch photos or play music and videos on TV from a PC or another storage device in your home network.

To browse your PC network, first set up the network connection, read Setup > Network.

If the network is not installed the first time you try to Browse PC network, the Network installation starts. Follow the instructions on screen.

Browse PC Network

Close this user manual, press , select Browse PC network in the Home menu and press OK.

With the PC and router switched on, the TV displays the multimedia server content from your PC.

With the PC content list open on screen, select the file you want to play and press OK or play .

A song, a slideshow of photos or a video starts playing.

...

3.6.2 Browse PC Network

2/2

To pause, press ▶⏸ again.

To jump to the next file, press ▶ or P +.

To jump to the previous file, press ◀ or P -.

To fast forward a music file, press ▶▶.

Press Options  to Play once, Repeat, Shuffle, Rotate and much more.

Watch videos

Select a video in the Guide menu and press play ▶▶. To pause the video, press pause ▶⏸.

To fast forward, press ▶▶ once to go slow, press twice to go fast. Press again for normal speed.

Press Options  to change to Full screen, Small screen, Play once, etc.

To exit the PC network, press  and select another activity.

3.7 Scenea

1/3

With Scenea, you can set a photo as a 'wallpaper' photo on your screen. Use any photo from your collection.

Press  to open the Home menu, select Scenea and press OK. The wallpaper photo is shown and there is no sound.

To exit Scenea, press any key on the remote control.

...

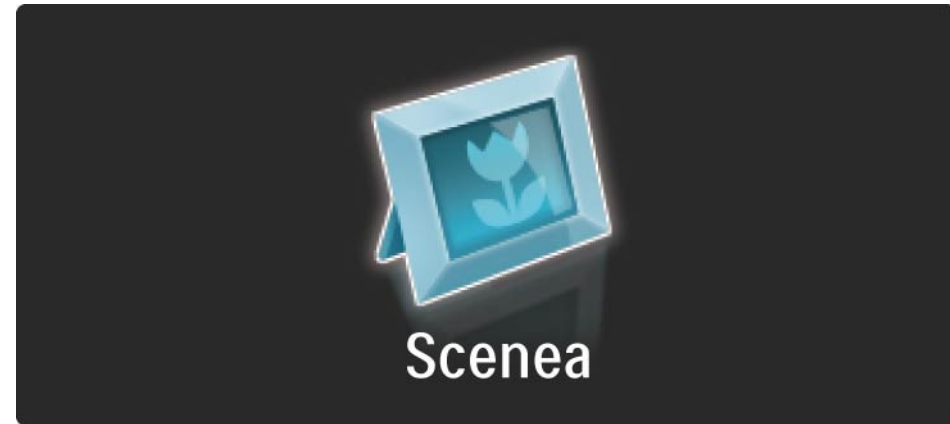

3.7 Scenea

2/3

We recommend setting the TV to the energy conscious Standard settings before you switch on Scenea.

Press Options  and select Picture and sound > Smart settings > Standard.

Select a new photo

1 Connect a USB device that holds your new photo to the TV. This photo must be in a JPEG format.

2 Highlight the photo in the USB content list with the navigation keys. If the content list does not appear automatically, press  and select Browse USB.

3 With the new photo highlighted, press Options  and select Set as Scenea. Agree to overwrite the current photo.

4 Disconnect the USB device and select Scenea in the Home menu to view the new photo.

...

3.7 Scenea

3/3

Limitations

When Scenea is on, the TV will automatically switch to standby after 4 hours. The TV will show a message 1 minute before switching to Standby. The switching to Standby prevents unnecessary energy use in case you forget that Scenea is switched on.

If the Sleptimer is set, the TV will also switch to standby after the set time has elapsed.

3.8.1 Hearing impaired

Some digital TV channels broadcast special audio and subtitles adapted for people who are hearing impaired.

To switch on hearing impaired audio and subtitles, press  > Setup > Installation > Languages > Hearing impaired. Select On and press OK.

The TV switches to hearing impaired audio and subtitles, if available.

To verify whether a hearing impaired audio language is available, press Options  and select Audio language and look for an audio language with an ear icon.

3.8.2 Visually impaired

Some digital TV channels broadcast special audio adapted for people who are visually impaired. The normal audio is mixed with extra commentary.

To switch on visually impaired audio, press Options  while watching the digital TV channel and select visually impaired. Select On and press OK.

The TV switches to visually impaired audio, if available.

In the Options menu, you can set the visually impaired audio to be heard from the Speakers, the Headphones only or from both Speakers and headphones.

Also in the Options menu, select Volume - Visually impaired to change the volume of the extra commentary.

To verify whether a visually impaired audio language is available, press Options  and select Audio language and look for an audio language with an eye icon.

4.1.1 Smart settings

You can set the TV to the predefined setting that is best for what you're watching at the moment. Each setting combines picture, sound and Ambilight.

While watching TV, press Options  and select Picture and sound. Press OK.

Select Smart settings and press OK.

Select a setting from the list and press OK.

- **Personal** — Sets the TV to your personal preferences set in the Picture, Sound and Ambilight menus in Setup.
- **Vivid** — Rich and dynamic settings, ideal for daylight use.
- **Natural** — A natural picture setting.
- **Cinema** — Ideal settings for watching movies.
- **Game** — Ideal settings for gaming.
- **Standard** — The factory standard and most energy conscious settings.

4.1.2 Picture

1/4

In the Picture menu, you can adjust all picture settings individually.

Close this user manual and press  > Setup > Picture.

Use ◀ or ▶, ▲ or ▼ to select and adjust a setting.

Press OK to activate a setting.

- Settings assistant

Start the Settings assistant to guide you through basic picture settings easily.

Follow the instructions on screen.

- Contrast

Changes the level of brightness in the picture but the level of darkness remains the same.

- Brightness

Changes the level of light in the whole picture.

- Colour

Changes the level of saturation.

...

4.1.2 Picture

2/4

- Hue

If NTSC is broadcast, this level compensates the colour variations.

- Sharpness

Changes the level of sharpness of fine details.

- Noise reduction

Filters out and reduces the noise in the picture. Set levels to Minimum, Medium, Maximum or Off.

- Tint

Sets the colours to Normal, Warm (reddish) or Cool (bluish). Select Custom to make your own personal settings in the Custom menu.

- Custom tint

Use a slider bar to change the colour temperature of the picture ...

- R-WP red whitepoint

- G-WP green whitepoint

- B-WP blue whitepoint

- R-BL red blacklevel

- G-BL green blacklevel

...

4.1.2 Picture

3/4

- Perfect Pixel HD

Controls the advanced settings of the Perfect Pixel HD Engine.

- HD Natural Motion

Removes motion judder and reproduces smooth movement, especially in movies.

- 200 Hz Clear LCD (100 Hz Clear LCD for 32" and 37")

Gives a superior motion sharpness, better black level, high contrast with a flicker-free, quiet image and a larger viewing angle.

- Advanced sharpness

Enables superior sharpness, especially on lines and contours in the picture.

- Dynamic contrast

Sets the level at which the TV automatically enhances the details in the dark, middle and light areas of the picture.

- Dynamic backlight

Sets the level at which power consumption can be reduced by dimming the brightness intensity of the screen. Choose for the best power consumption or for the picture with the best brightness intensity

...

4.1.2 Picture

- MPEG artefact reduction

Smooths the digital transitions in the picture.

- Colour enhancement

Makes the colours more vivid and improves the resolution of details in bright colours

- PC mode

Sets the TV to the ideal predefined computer setting in case a computer has been connected.

- Light sensor

Adjusts the picture and Ambilight settings automatically to the lighting conditions of the room. Switches the Light sensor on or off.

- Picture format / auto format mode

Read Use your TV > Watch TV > Adjust the picture format

- Picture shift

To shift the picture vertically on the screen with the cursor keys.

4.1.3 Sound

1/3

In the Sound menu, you can adjust all sound settings individually.

Close the user manual and press  > Setup > Sound.

Use ◀ or ▶, ▲ or ▼ to select and adjust a setting.

Press OK to activate a setting.

- Bass

Changes the low tones of the sound. Select each bar to change the setting.

- Treble

Changes the high tones of the sound. Use each slider bar to change the setting.

- Volume

Changes the volume.

If you do not want the volume bar to appear, press  > Setup > Installation > Preferences > Volume bar. Select Off and press OK.

...

4.1.3 Sound

- **Volume — visually impaired**

Changes the volume of the selected visually impaired audio language. (Only for UK.)

- **Audio language**

Shows the list of broadcast audio languages of digital TV channels.

You can set your preferred audio language in  > Setup > Installation > Languages > Primary audio.

- **Dual I/II**

If broadcast is available, you can choose between two different languages.

- **Mono/stereo**

If stereo broadcasting is available, you can select Mono or Stereo for each TV channel.

- **TV speakers**

If you have an audio system connected to your TV, you can switch off the TV speakers.

If your audio system supports EasyLink, read Connections > EasyLink.

Select Automatic (EasyLink) to have the sound from your TV automatically reproduced by your audio system.

...

4.1.3 Sound

3/3

- Surround

Switches the TV automatically to the best surround sound mode dependant on the broadcast. Select On or Off.

- Headphones volume

Changes the volume of the headphones.

You can mute the TV speakers with .

- Delta volume

Levels out volume differences between channels

or connected devices. First, switch to the channel or device whose volume difference you want to level out.

- Balance

Sets the balance of the left and right loudspeakers to best fit your listening position.

- Auto volume levelling

Reduces sudden volume differences like at the beginning of commercials or when switching from one channel to another. Select On or Off.

4.1.4 Ambilight

In the Ambilight menu, you can adjust all Ambilight settings individually.

Close the user manual and press  > Setup > Ambilight.

Use ◀ or ▶, ▲ or ▼ to select and adjust a setting.

Press OK to activate a setting.

For more on Ambilight, read Use your TV > Use Ambilight.

4.1.5 Factory settings

You can return to the original factory settings.

Only picture, sound and Ambilight settings will be reset.

Close the user manual and press  > Setup > Installation
> Factory reset and press OK.

4.2.1 Reorder and rename

1/2

After the first installation, you might want to reorder or rename installed channels. Organise TV channels in the Channel overview according to your own preference or give them a recognisable name.

While watching TV, press OK to open the Channel overview. The Channel overview shows the TV channels and radio stations installed on your TV.

To reorder or rename, press Options  and select the option you need.

Reorder

You can reposition channels within the overview.

1 Select Reorder in the Options  menu to start reordering channels.

2 Highlight a channel and press OK.

...

4.2.1 Reorder and rename

3 Reposition the channel where you want it with the navigation keys.

4 Press OK to confirm the position.

You can highlight another channel and do the same.

To stop Reorder, press Options  and select Exit reorder.

Rename

You can rename a channel.

1 In the channel overview, navigate to the channel you want to rename.

2 Select Rename in the Options  menu.

3 Use the navigation keys to position the highlight. Press Back  to delete a character. Use the remote control number pad as you do for SMS/text messaging to select a character. Use the 0 number key to select a special character. Select Clear to clear all text.

4 Select Done and press OK to end Rename.

4.2.2 Update channels

1/2

When the TV was switched on for the first time, a full installation of channels was performed.

You can set the TV to add or remove digital channels automatically. You can also manually start the channel update.

Automatic update

To set the TV to update digital TV channels automatically, leave the TV in standby mode. Once a day, at 6 AM, the TV updates earlier found channels and stores new channels. Empty channels are removed from the Channel overview.

If a channel update has been performed, a message shows at TV start up.

If you do not want this message to appear, select No in **🏠 > Setup > Installation > Channel installation > Channel update message**.

...

4.2.2 Update channels

2/2

Manual update

To update channels yourself at any time, press  > Setup > Installation > Channel installation > Automatic installation and press OK.

Start the update and select Update Channels.

The update may take a few minutes.

4.2.3 Reinstall channels

When the TV was switched on for the first time, a full installation of channels was performed.

You can redo this full installation all over again to set your language, country and install all available TV channels.

Full installation

To reinstall the TV, press  > Setup > Installation > Channel installation > Automatic installation and press OK.

Start the installation and select Reinstall channels.

The update may take a few minutes.

To reorder or rename found channels, read Setup > Channels > Reorder and rename.

4.2.4 Digital reception quality

1/2

If you receive digital TV broadcasting (DVB) from your own antenna (DVB-T) or use the TV tuner to receive digital cable channels (DVB-C), you can verify the quality and signal strength of a channel.

If the reception is poor, you can reposition your antenna to try to improve the reception. For best results, contact a specialised antenna installer.

To verify the reception quality of such a digital channel, select the channel, press  > Setup > Installation > Channel installation > Reception test > Search and press OK.

The digital frequency is shown for this channel.

If the reception is poor, you can reposition your antenna. Select Search and press OK to verify the signal quality of this frequency again.

...

4.2.4 Digital reception quality

2/2

You can enter a specific digital frequency yourself.

Select the frequency, position the arrows on a number with ► and ◀ and change the number with ▲ and ▼. Press Search to verify this frequency.

If you receive the channel with DVB-C, the options Symbol rate mode and Symbol rate are shown.

For Symbol rate mode, select Automatic unless your cable provider supplies a specific symbol rate value. You can enter this supplied value in Symbol rate using the number keys.

4.2.5 Manual installation of analogue channels

1/2

Analogue TV channels can be manually tuned-in channel by channel.

To start the manual installation of analogue channels, press **⬆** > Setup > Installation > Channel installation > Manual install - analogue.

Follow each step in this menu.

You can redo these steps until you have all available analogue TV channels.

1 System — If you have your own antenna, you need to select the country or part of the world where the TV channel comes from. If you receive TV channels via a cable system, you only need to select the country or part of the world once.

2 Find channel — Search for an analogue TV channel. The search starts automatically but you can manually enter a frequency. If the channel reception is bad, select Search next to search again. Select Done and press OK if you want to store this TV channel.

...

4.2.5 Manual installation of analogue channels

2/2

3 Fine tune — Fine tune the found channel with ▲ and ▼.
Press Done once the channel is fine tuned.

4 Store — A found channel can be stored on the current channel number with Store current channel or as a new channel number with Store as new channel.

4.2.6 Fine tune analogue channels

If the reception of an analogue TV channel is poor, you can try to fine tune the TV channel.

To fine tune analogue channels, press **⬆** > Setup > Installation > Channel installation > Manual install - analogue > Fine tune.

Fine tune the channel with **▲** and **▼**. Press Done once the channel is fine tuned.

You can store this fine tuned channel on the current channel number with Store current channel or as a new channel number with Store as new channel.

4.2.7 DVB-T or DVB-C

If both DVB-T and DVB-C reception is available in your country, and this TV is prepared for both DVB-T and DVB-C for your country, you need to select DVB-T or DVB-C before you install TV channels.

To select DVB-T or DVB-C reception, press  > Setup > Installation > Channel installation > Antenna/Cable DVB.

Select Antenna for a DVB-T installation.

Select Cable for a DVB-C installation.

DVB-C channel installation

All DVB-C TV settings are set to automatic but the DVB-C network might need some settings supplied by the DVB-C provider. Enter these settings or values when the TV asks for them.

You can install your TV for DVB-T and DVB-C. In that case, you need to carry out two channel installations. First, carry out an installation with Antenna selected followed by an installation with Cable selected. Afterwards, the Channel overview will show both DVB-T and DVB-C TV channels.

4.2.8 Clock settings

In some countries, digital TV broadcasts do not send UTC – Coordinated Universal Time information. Therefore, winter and summer time changes might be ignored. You can correct this with the clock settings.

If the TV shows the incorrect time, press  > Setup > Installation > Clock > Auto clock mode and select Manual.

In the Daylight saving menu, select Standard time (winter) or Daylight saving time (summer) according to your local time.

4.3.1 Network benefits

PC network

If the TV is connected to your PC network, you can play photos, music and movies from a computer or storage device in that network.

Once the network is installed, select Browse PC network in the Home menu to view the PC content.

Net TV

If the TV is connected to the PC network, which is connected to the Internet, you can link up your TV to Net TV. The Net TV start page offers you movies, pictures, music, infotainment, games and many more, all fit for your TV screen.

Once the network is installed, select Browse Net TV in the Home menu or simply press Net TV on the remote control to open the Net TV start page.

4.3.2 What you need

1/2

To connect the TV to a PC network and Internet you need a router in your PC network. The router needs to be set to DHCP On.

To enjoy Net TV you need to connect the TV to a router with a high speed connection to the Internet.

The TV connection to the router can either be wired or wireless.

If you choose a wired connection to the router you need a network (Ethernet) cable.

...

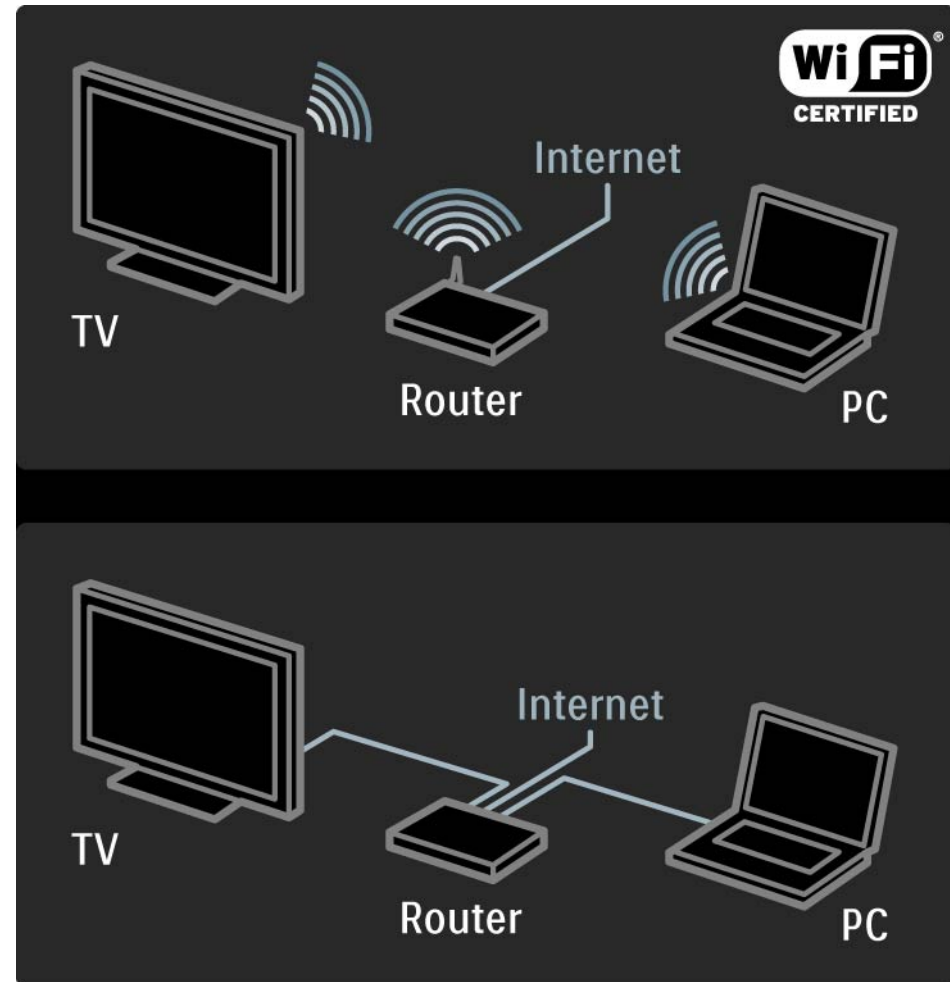

4.3.2 What you need

The PC network feature is DLNA certified.

You can use Microsoft Windows XP or Vista, Intel Mac OSX or Linux on your computer.

To share PC content on your TV, you need recent media server software on your computer.

A Windows Media Player 11 or similar.

Some media server software needs to be set to share files with the TV.

For the list of supported media server software, read [Technical data > Multimedia](#).

4.3.3 Wireless installation

1/3

The onscreen instructions help you to install the wireless network.

Switch on your router before you start the network installation. If your wireless network is secured, have the encryption key ready to enter onscreen.

To start the wireless network installation on the TV, close the user manual, press  > Setup > Installation > Network > Network installation and press OK.

Follow the onscreen instructions.

...

4.3.3 Wireless installation

2/3

Name and security

The TV scans for your network router. Found routers appear in a list on screen. If several routers are found, select your router in the list and press OK.

If the router name is unknown to you or you do not recognize your router's name, look up the SSID (Service Set Identifier) in the router software on your PC.

When you have chosen your router, the TV asks for the encryption key -the security key- to access the router.

...

4.3.3 Wireless installation

3/3

If you have WPA security on your router, enter the passphrase with the characters on the remote control. If you have WEP security, the TV asks for the WEP encryption key in hexadecimal numbers. Find this hexadecimal key in the router software on your PC. Write down the first key of the WEP keys list and enter it on TV with the remote control keypad.

If the security key is accepted, the TV is connected with the wireless router.

Next time you start the wireless network, there is no need to enter the security key. The TV uses the security key you entered in the installation.

If asked for, agree to the End User License Agreement.

4.3.4 Wired installation

The onscreen procedure helps you to install the wired network.

Connect the router to the TV using a network cable and switch on the router before you start the network installation.

To start the wired network installation, close the user manual, press **⬆** > Setup > Installation > Network > Network installation and press OK.

Follow the instructions on screen.

The TV constantly searches for a network connection.

If asked for, agree to the End User License Agreement.

Find the latest End User License Agreement at www.philips.com.

4.3.5 Network settings

The TV's network settings that are used to connect to your router are standard and set to automatic. This ensures easy connection with any available network.

If you have problems with the network connection, you might want to adjust the settings so that they are appropriate for your home network.

If you are unsure, ask someone with knowledge of network settings to help you.

To set specific network settings, press  > Setup > Installation > Network > Network mode and/or ... > IP configuration.

4.3.6 PC Media server settings

Media servers need to be set for sharing their files and folders. Follow the instructions closely to set your specific server.

Windows Media Player v11 on Windows Vista

Set for network sharing

In Windows Media Player select **Library** from the menu and select **Media sharing**.

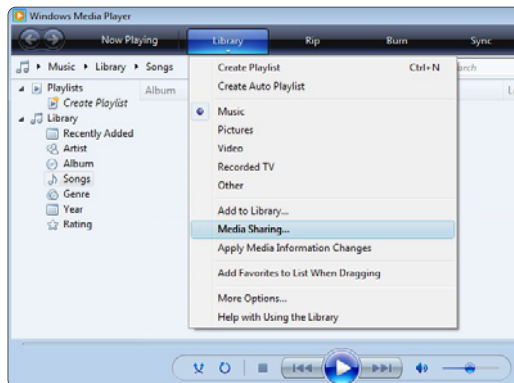

In the **Media Sharing** window, check the **Share my media** box. Click **OK**.

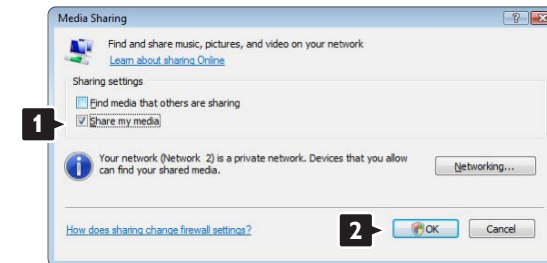

If no network connection was found, and you are unable to check this box, click the **Networking** button to show the **Network and Sharing Center** window, ...

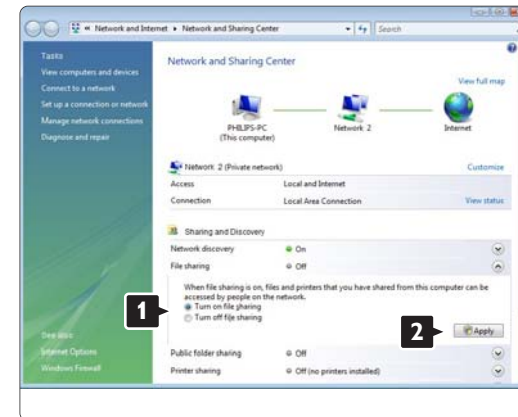

Set **Network discovery** to **On**.

Set **File sharing** to **On**.

Go back to the **Media Sharing** window in **Windows Media Player** and check the **Share my media** box. Click **OK**.

When the TV is connected, by the router, to the PC and everything is switched **On**, the **Media sharing** window will show the TV as an **Unknown Device**.

Select the device and click **Allow**.

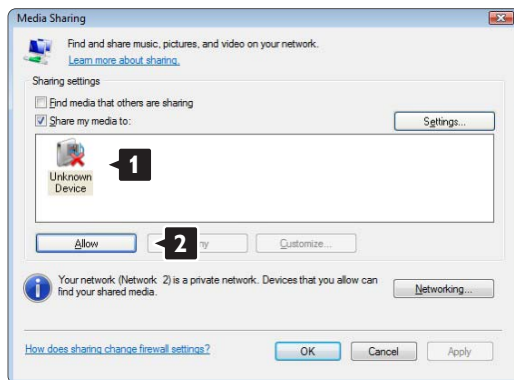

You can open the **Settings** window to change particular settings on sharing.

When the device icon (the TV) is checked with a green tick, click **OK**.

Set folders for sharing

In **Windows Media Player** select **Library** from the menu and select **Add to Library**.

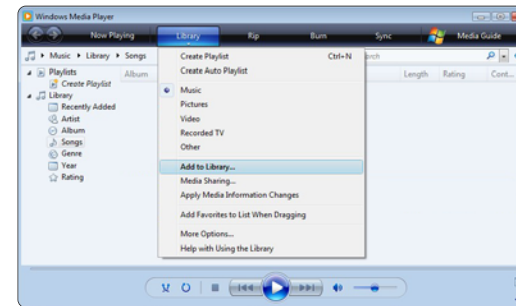

In the **Add To Library** window, select **My folders and those of others that I can access** and click the **Advanced Options** button. ...

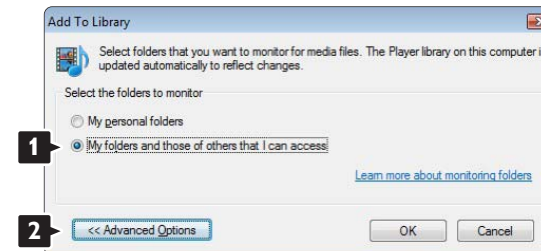

With **Advanced Options** open, you can add specific folders to the list to share. **Click Add.**

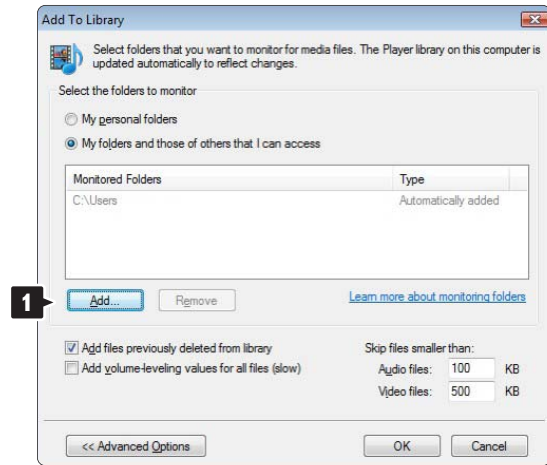

In the **Add To Library** window the newly added folder is shown. You can add more folders to share. **Click the OK** button to add the files to the library.

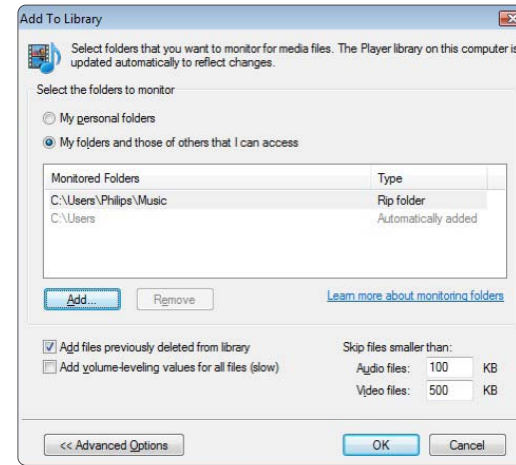

In the **Add Folder** window select a folder with music, photos or videos you want to share with other devices (your TV). **Click OK.**

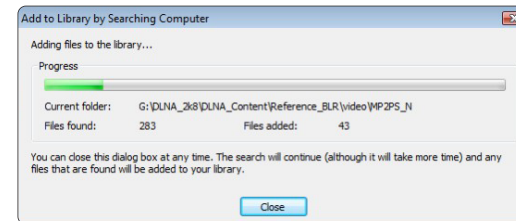
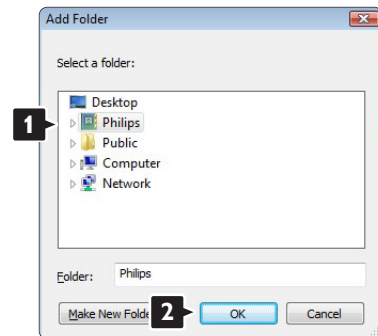

Now everything is set to enjoy music, photos and videos on your TV.

Windows Media Player v11 on Windows XP

Set for network sharing

In Windows Media Player select **Library** from the menu and select **Media sharing ...**



In the **Media Sharing** window, check the **Share my media box**.

When the TV is connected, by the router, to the PC and everything is switched On, the **Media sharing** window will show the TV as an **Unknown Device**. Select the device and click **Allow**.

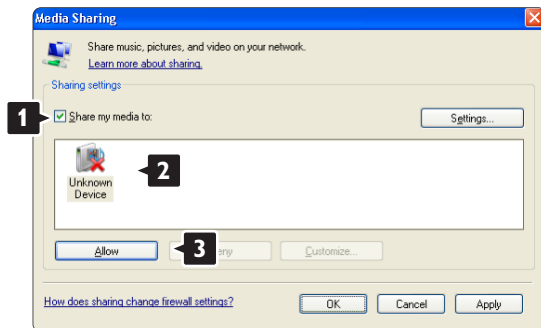

You can open the **Settings** window to change particular settings on sharing.

When the device icon (the TV) is checked with a green tick, click **OK**.

Set folders for sharing

In Windows Media Player select **Library** from the menu and select **Add to Library**.



In the **Add To Library** window, select **My folders and those of others that I can access** and click the **Advanced Options** button.

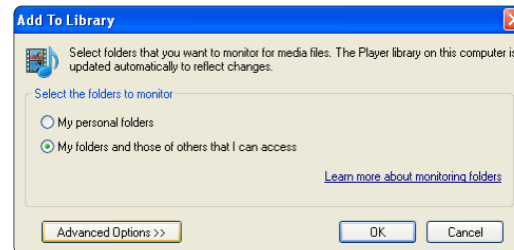

With **Advanced Options** open, you can add specific folders to the list to share. Click **Add**.

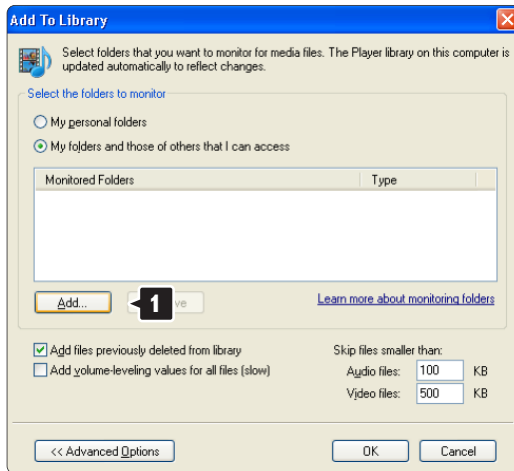

In the **Add To Library** window the newly added folder is shown. You can add more folders to share. Click the **OK** button to add the files to the library.

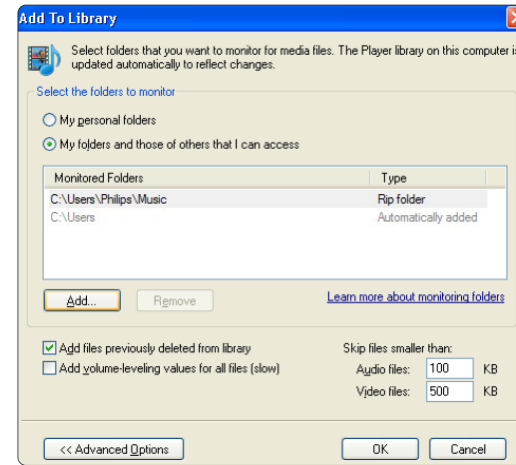

In the **Add Folder** window select a folder with music, photos or videos you want to share with other devices (your TV). Click **OK**.

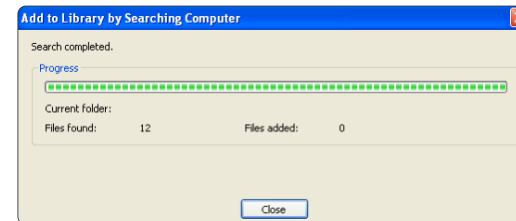
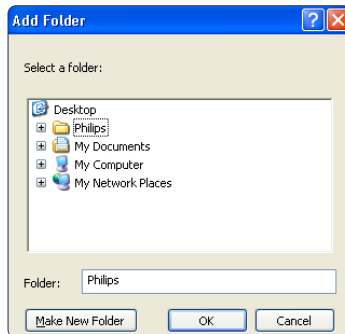

Now everything is set to enjoy music, photos and videos on your TV.

TVersty v.0.9.10.3 on Windows XP

Set for network sharing

Click the **Settings** tab and click the **Start Sharing** button.



A pop-up window tells you that the media server service is started. Click **OK**.



Click the **Sharing** tab.

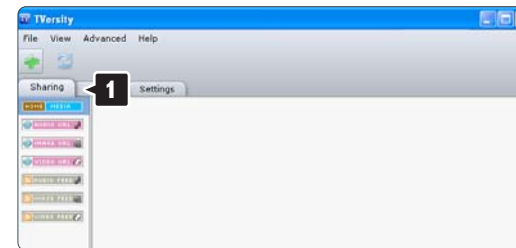

Set folders for sharing

Click the green plus icon and select **Add folder...**

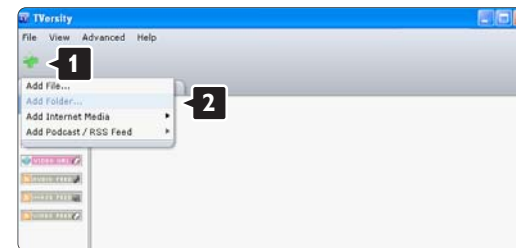

In the **Add media** pop-up window, click the **Browse** button.

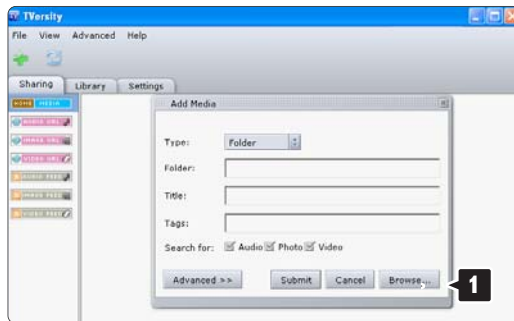

In the **Browse for Folder** window select a folder with music, photos or videos you want to share. Click **OK**.

Now everything is set to enjoy music, photos and videos on your TV.

Twonky Media v4.4.2 on Macintosh OS X

Set for network sharing

In Twonky Media click **Basic Setup > First steps**. In this window you can change the server name that appears on your TV.

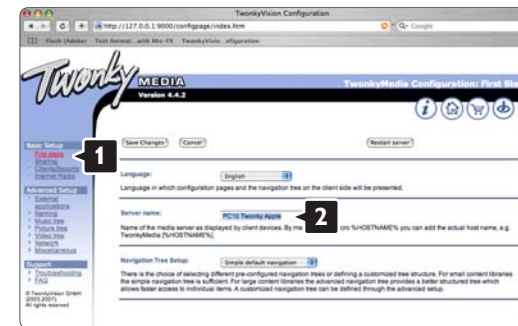

Click **Basic Setup > Clients/Security**. Check the box next to **Enable sharing for new clients automatically**.

Set folders for sharing

Click on **Basic Setup > Sharing**.

Some 'Content Locations' might be set already automatically. To add a folder (a content location) to be shared on the network click the **Browse** button.

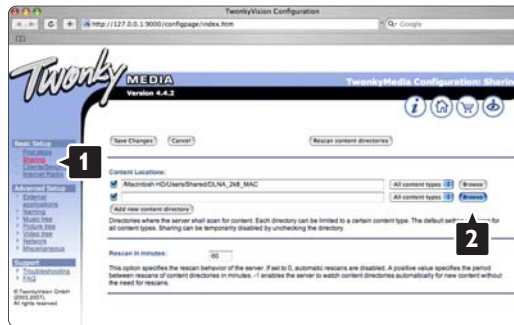

In the blue frame click the hard disk name to browse to a folder with music, photos or videos you want to share with other devices (your TV).

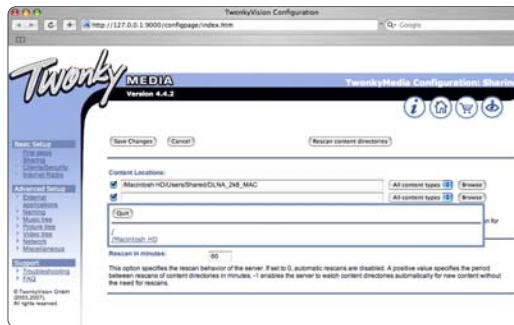

Click **Select** to select the folder for sharing.
Now click **Save Changes**.

Then click **Rescan content directories**.
In some cases this might not make all files and folders available.

Click **Support > Troubleshooting** and click **Rebuild database** to make sure everything works OK. This rebuilt might take a while.

Now everything is set to enjoy music, photos and videos on your TV.

4.4.1 Pixel Plus link

Some other devices, DVD or Blu-ray Disc players, might have their own picture quality processing. To avoid bad picture quality from interference with the TV processing, the picture processing of these devices should be discarded. With Pixel Plus link you can discard this picture quality processing.

Close this user manual and press  and select Setup > Installation > Preferences > Pixel Plus link. Select On to discard the picture processing from connected devices.

4.4.2 Audio sync

When a Home Theatre System is connected, the picture on your TV and the sound from the Home Theatre System should be synchronized. A mismatch is visible in scenes with people talking. When they finish sentences before their lips stop moving, you need to adjust the Audio sync delay on the Home Theatre System.

Consult the user manual of the Home Theatre System.

In case you cannot set this delay in the Home Theatre System or the maximum setting is insufficient, you can consider to switch off the HD Natural Motion picture processing of the TV.

Close this user manual and press  > Setup > Picture > Perfect Pixel HD > HD Natural Motion.

4.5.1 From the Internet

In some cases, it might be necessary to update the TV software. If your TV is connected to a router, which is connected to the Internet, you can update the TV software directly from the Internet. You need a high speed Internet connection.

Close this user manual, press  > Setup > Software update > Update now and press OK.

Select Internet and press OK.

Follow the instructions on screen.

When the update is done, the TV switches off and back on again automatically. Wait for the TV to switch back on; do not use the Power switch  on the TV.

If the TV is connected to the Internet, the TV displays a message about the availability of new software at start up.

4.5.2 With a USB memory device

1/3

In some cases, it might be necessary to update the TV software. Start the software update on the TV. Then, download the TV software from the Internet onto your PC. Use a USB memory device to upload the software from your PC to the TV.

Preparation

You need a PC with a high speed Internet connection. You will need a USB memory device with 256 Mb free space and make sure that the write protection is switched off. Some USB memory devices might not work with the TV.

...

4.5.2 With a USB memory device

2/3

1 Identification

Close this user manual, press  > Setup > Software update > Update now and press OK.

Select USB and press OK.

Follow the onscreen instructions.

The TV will ask to insert the USB device into the USB connector at the side of the TV.

2 Download from PC to USB

Once the TV identification file is written to the USB device, insert the USB into your PC that is connected to the Internet. On the USB device, locate the file 'update.htm' and double-click it. Click on Send ID. If new software is available it will download to the USB device.

...

4.5.2 With a USB memory device

3/3

3 Download from USB to TV

Insert the USB memory device back into the TV. Follow the onscreen instructions to start the new TV software update. The TV switches off for 10 seconds and back on again. Please wait.



Do not ...

- use the remote control
- remove the USB device from the TV during the software update

If a power cut occurs during the update, never remove the USB memory device from the TV. When the power returns, the update continues.

At the end of the update, the message Operation successful appears on screen. Remove the USB device and press  on the remote control.

Do not ...

- press  twice
- use the  switch on the TV

The TV switches off (for 10 seconds) and back on again. Please wait.

Now the new TV software update is finished.

You can use the TV again.

5.1.1 Power cable

Make sure the power cable is securely inserted in the TV. Make sure that the power plug in the wall socket is accessible at all times.

When disconnecting the power cable, always pull the plug, never the cable.

Although this TV has a very low standby power consumption, unplug the power cable to save energy if you do not use the TV for a long time.

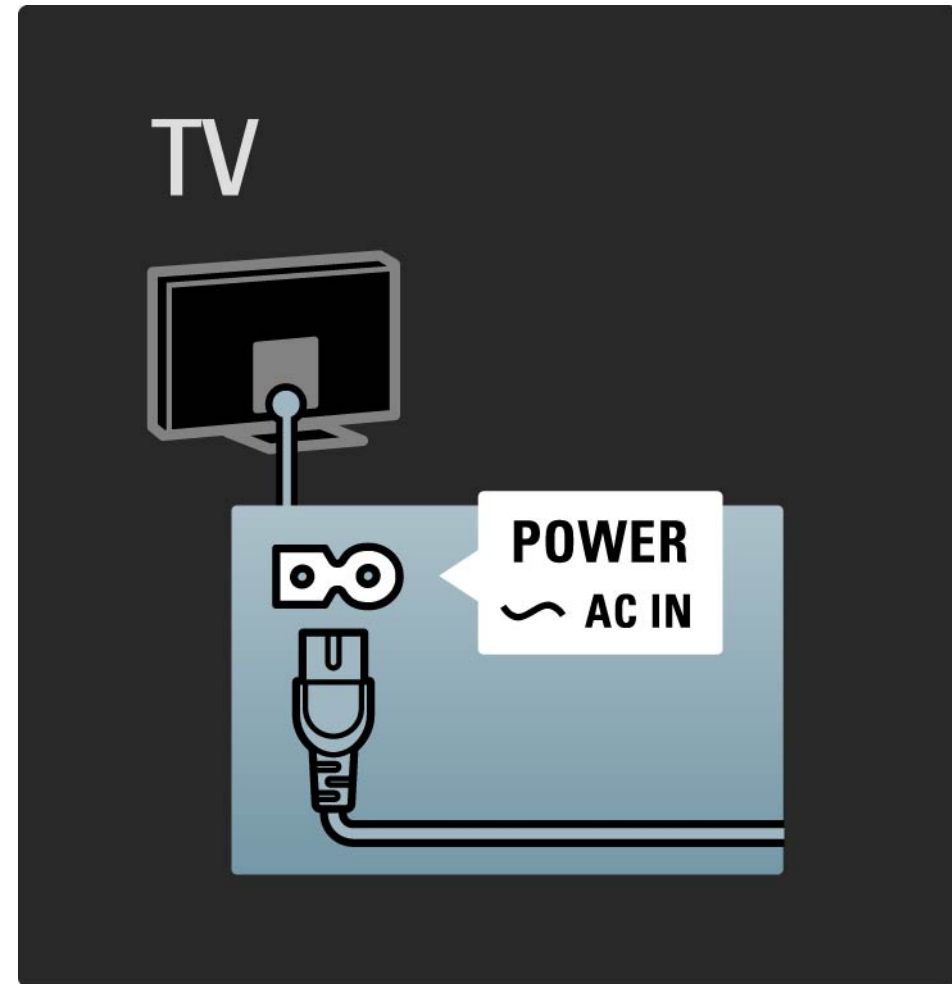

5.1.2 Antenna cable

Locate the antenna connection at the back of the TV. Insert the antenna cable securely in the Antenna  socket.

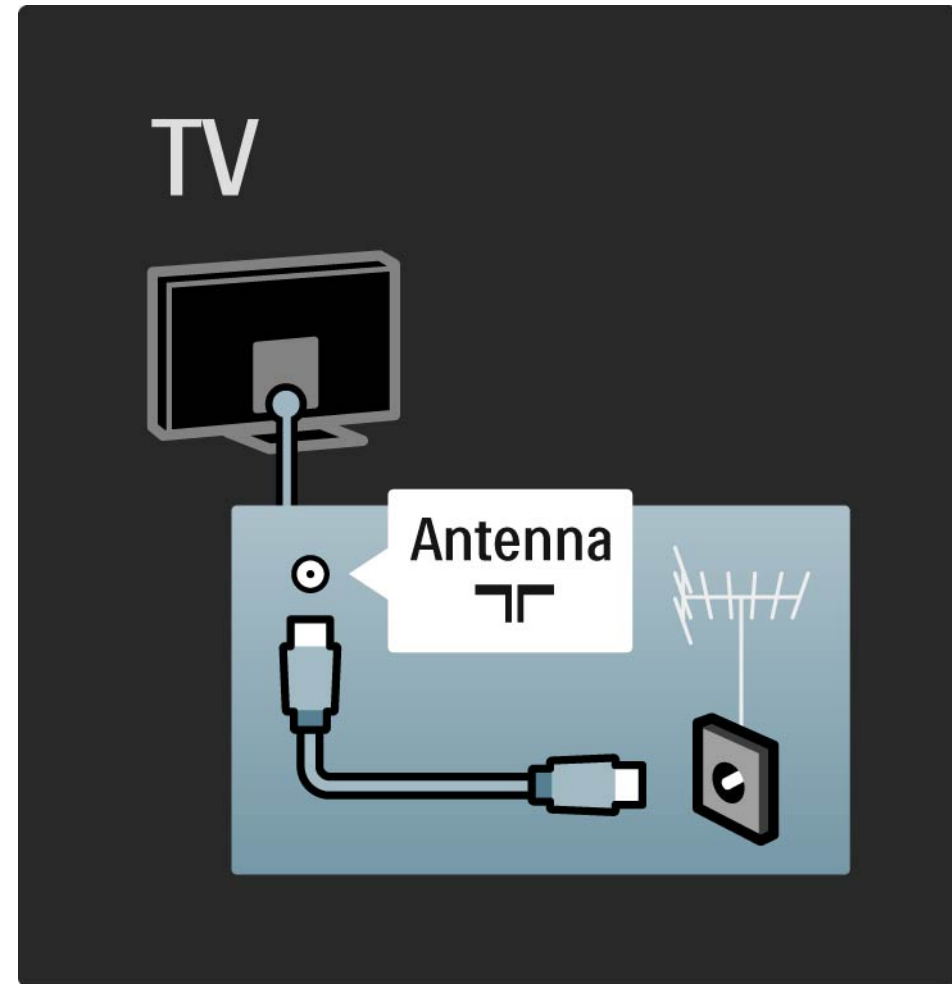

5.2.1 Cable quality

Before you connect devices to the TV, verify which connectors are available on the device. Connect the device to the TV with the highest quality connection available. Good quality cables ensure a good transfer of picture and sound.

The connections shown in this user manual are recommendations for the cases most used. Other solutions are possible.

Read more on specific cable types and available connections in [About cables > HDMI ... etc.](#)

Add your devices

When you have connected a device to the TV, always add this device as an item in the Home menu. With this item in the Home menu, you can easily switch the TV to this device.

To add a new device, press  > Add your devices. Follow the instructions on screen.

5.2.2 HDMI

1/2

An HDMI connection has the best picture and sound quality.

One HDMI cable combines video and audio signals.

Use HDMI for High Definition (HD) TV signals.

An HDMI cable transfers picture and sound signals in only one direction, the opposite to a scart cable.

Do not use an HDMI cable longer than 5 m.

...

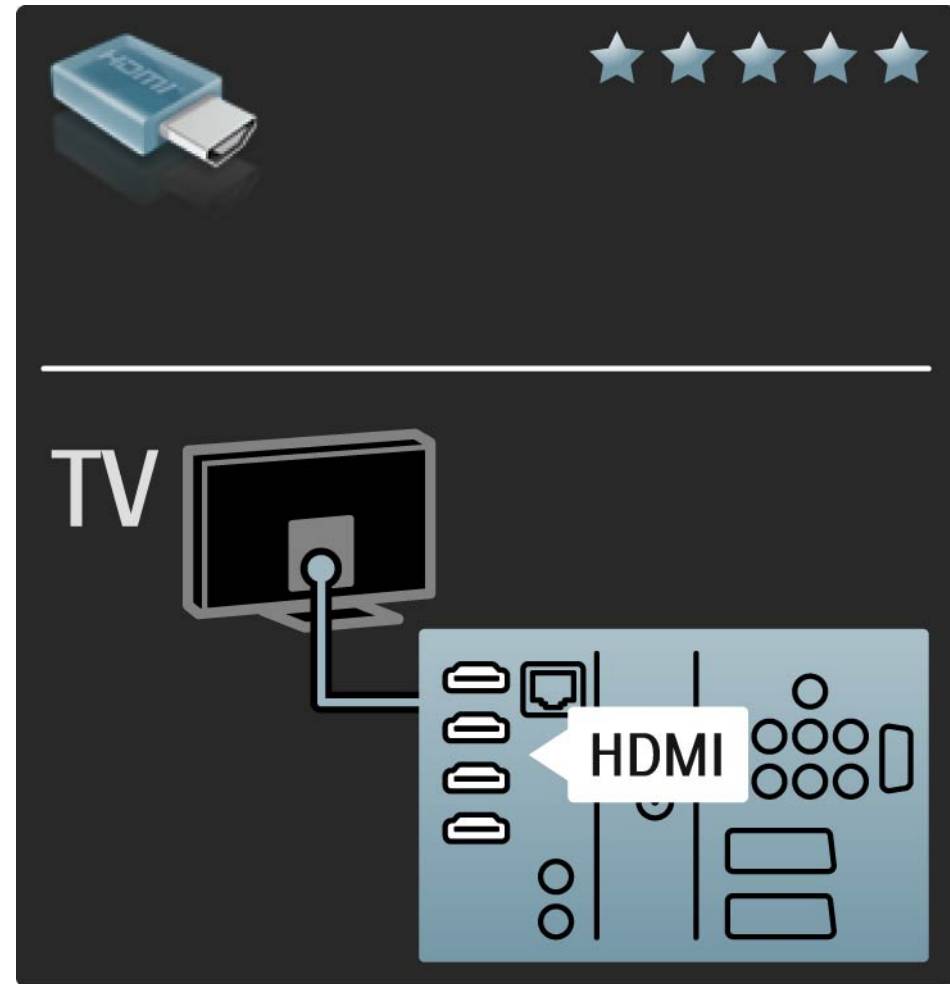

5.2.2 HDMI

HDMI supports HDCP (High-bandwidth Digital Contents Protection). HDCP is a copy protection signal that comes with HD content (DVD disc or Blu-ray Disc).

DVI to HDMI

Use a DVI to HDMI adaptor if your device has only a DVI connection. Use one of the HDMI connectors and add an Audio L/R cable to DVI ► HDMI, Audio In L/R for sound, at the back of the TV.

EasyLink

HDMI with EasyLink offers easy operating of your connected devices when these have the HDMI CEC standard.

Read Connections > EasyLink HDMI-CEC.

5.2.3 YPbPr – Component video

Use the Component Video YPbPr connection together with an Audio Left and Right connection for sound.

Match the YPbPr connector colours with the cable plugs when you connect. YPbPr can handle High Definition (HD) TV signals.

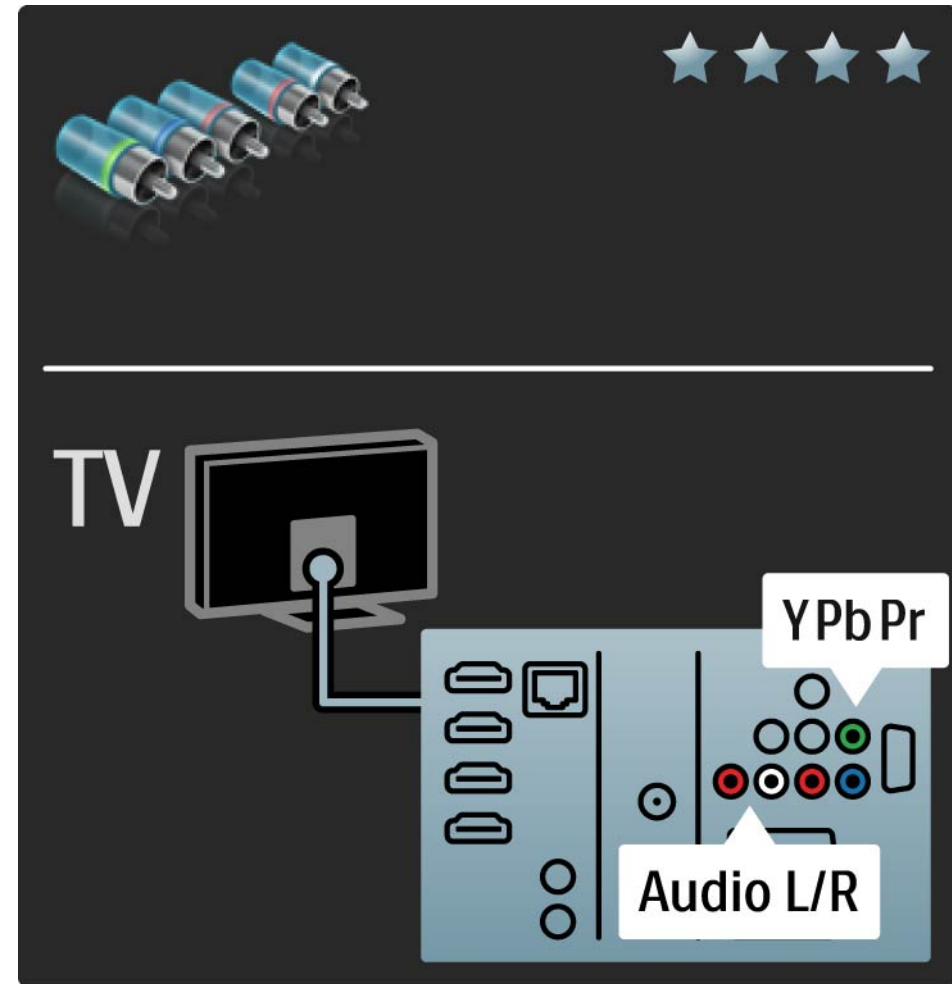

5.2.4 Scart

A scart cable combines video and audio signals. Scart connectors can handle RGB video signals but cannot handle High Definition (HD) TV signals.

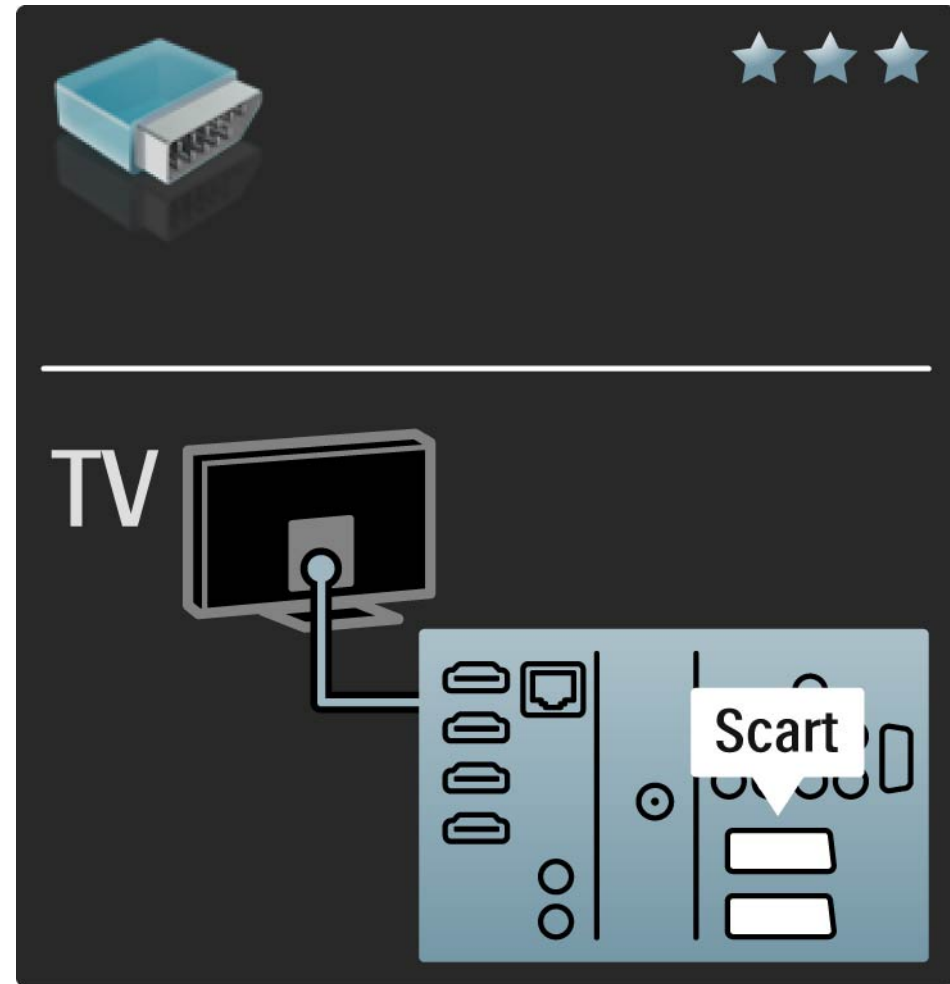

5.2.5 S-Video

Use an S-Video cable together with an Audio Left and Right (cinch) cable.

Match the Audio connectors' colours with the cable plugs when you connect.

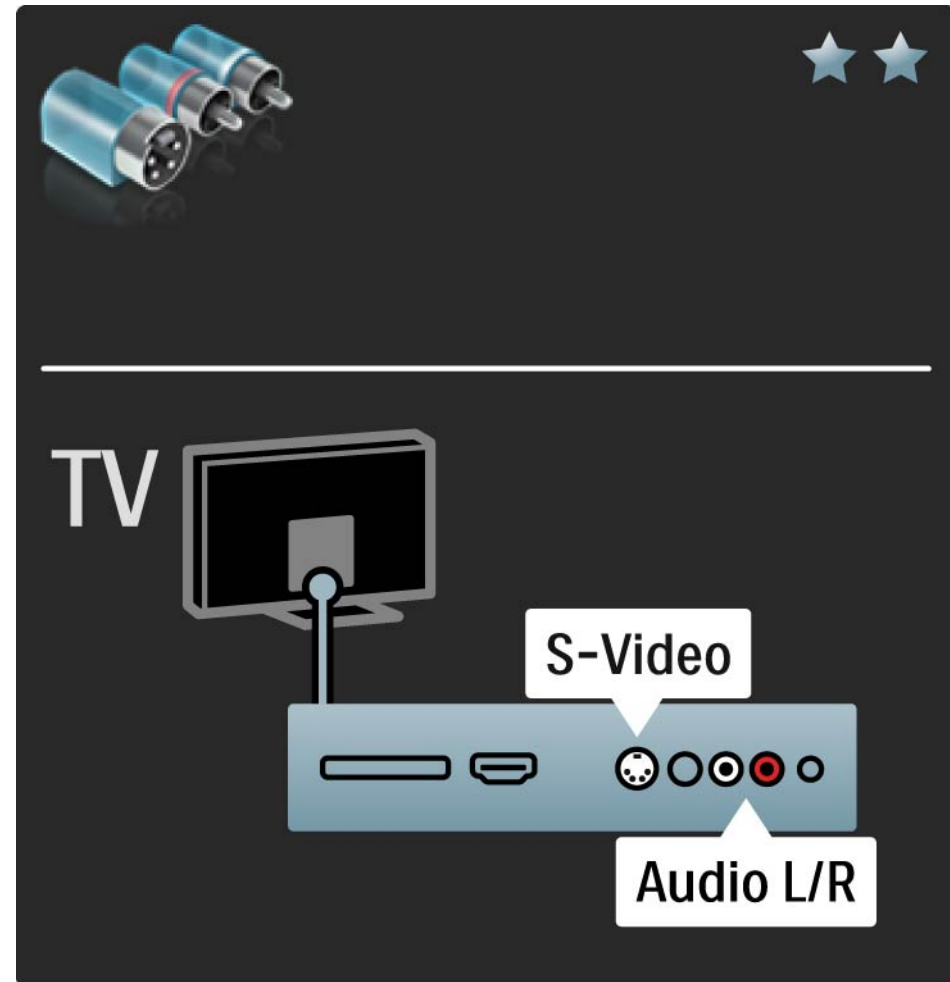

5.2.6 Video

Use a Video (cinch) cable together with an Audio Left and Right (cinch) cable.

Match the Audio connectors' colours with the cable plugs when you connect.

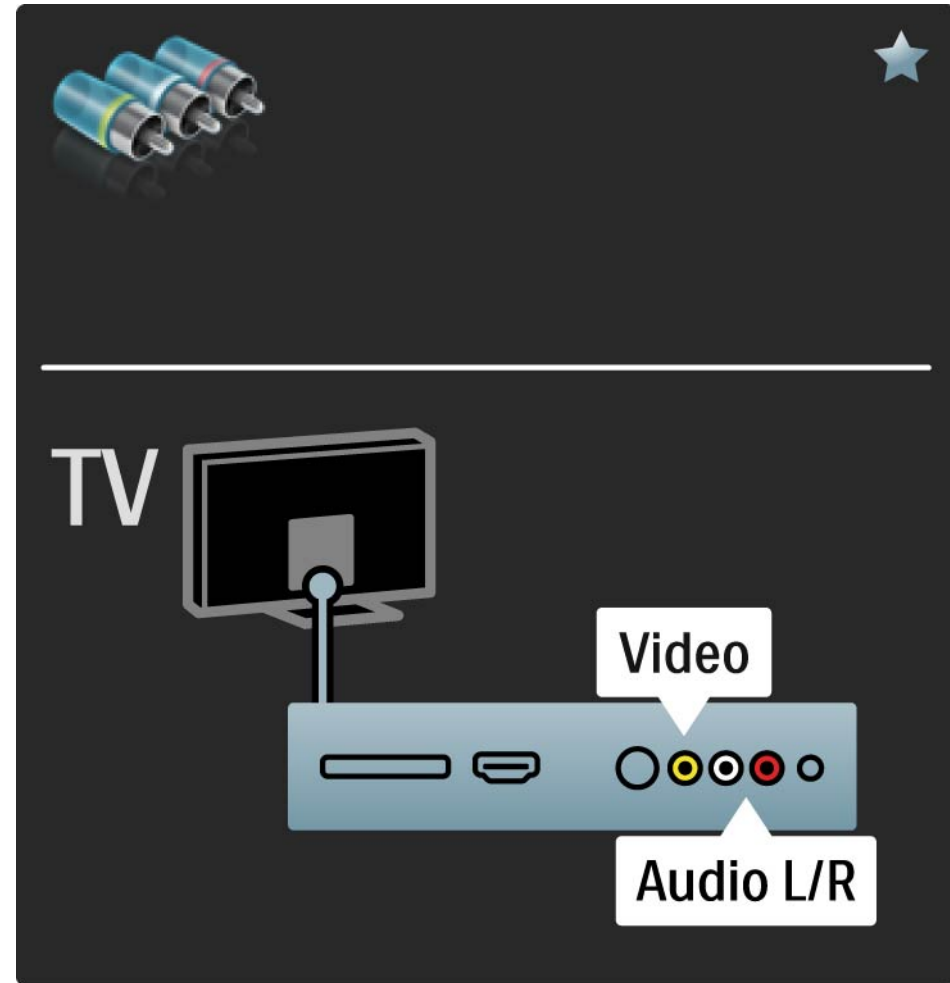

5.2.7 VGA

Use a VGA cable (DE15 connector) to connect a computer to the TV. With this connection you can use the TV as a computer monitor. You can add an Audio Left and Right cable for sound.

Read [Connections > More devices > TV as PC monitor](#).

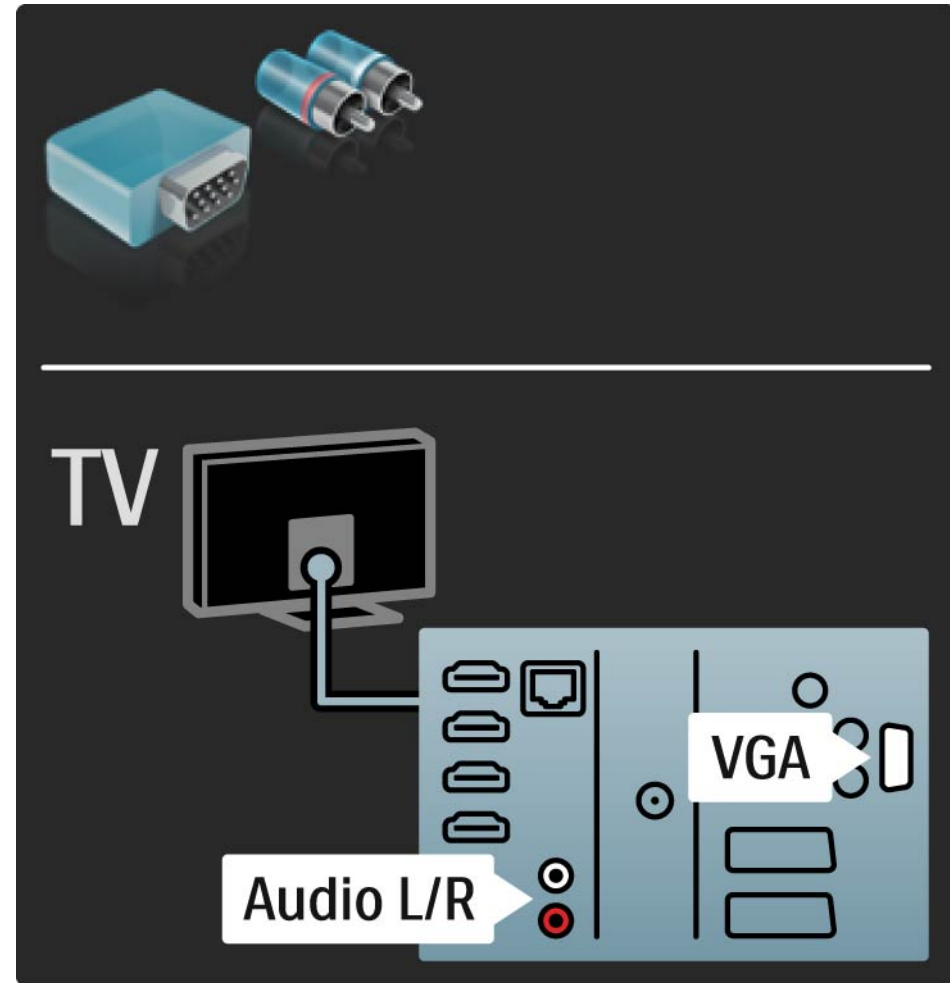

5.3.1 DVD player

Use an HDMI cable to connect the DVD player to an HDMI connector on the back of the TV.

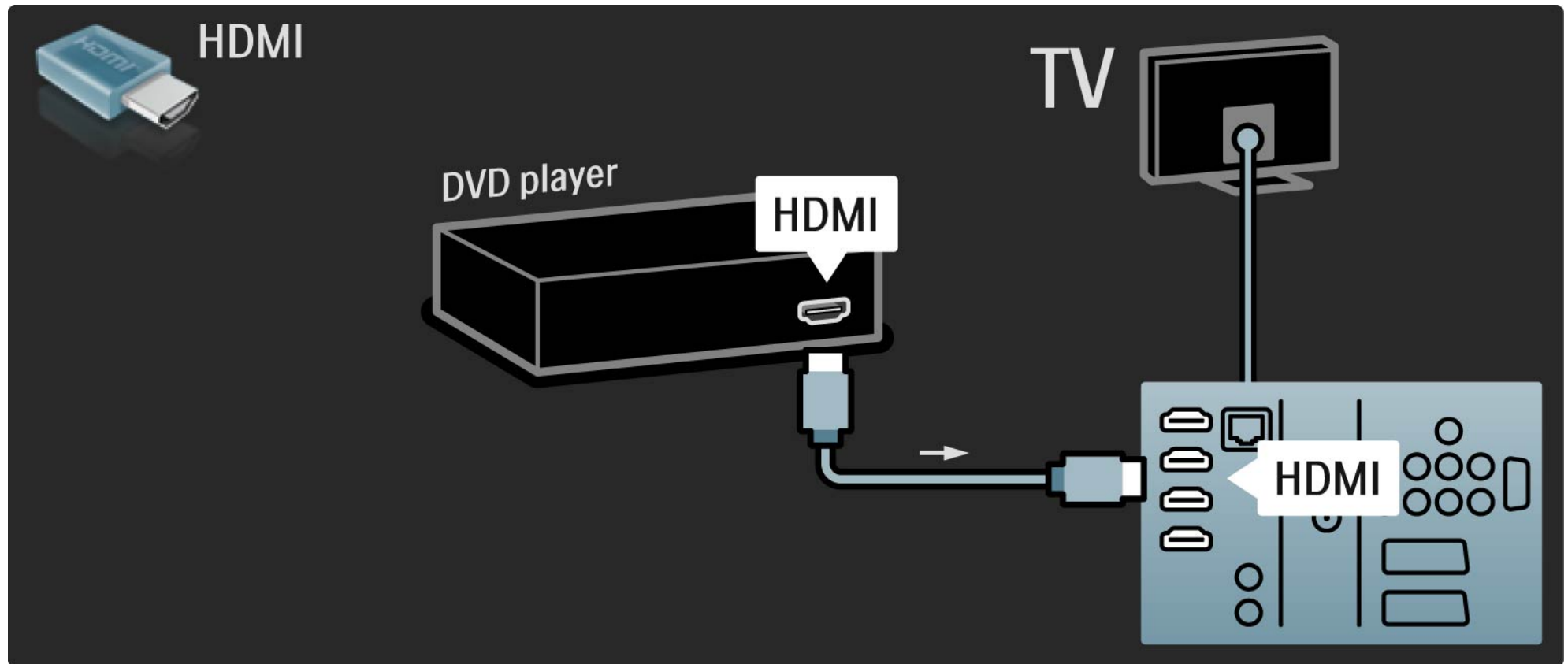

5.3.2 DVD Home Theatre System

1/3

First, use an HDMI cable to connect the device to the TV.

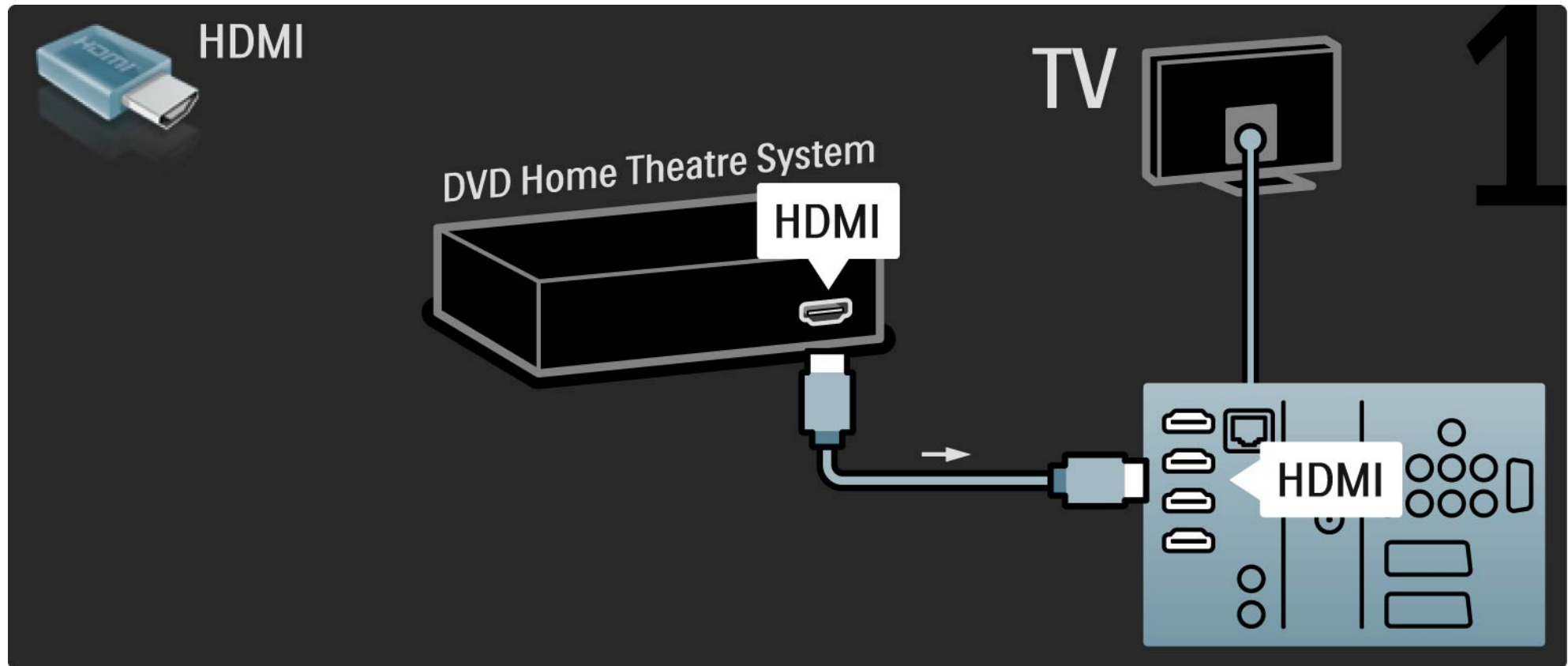

5.3.2 DVD Home Theatre System

Finally, use a digital audio cinch cable to connect the device to the TV or alternatively, use the analogue Audio Out L/R.

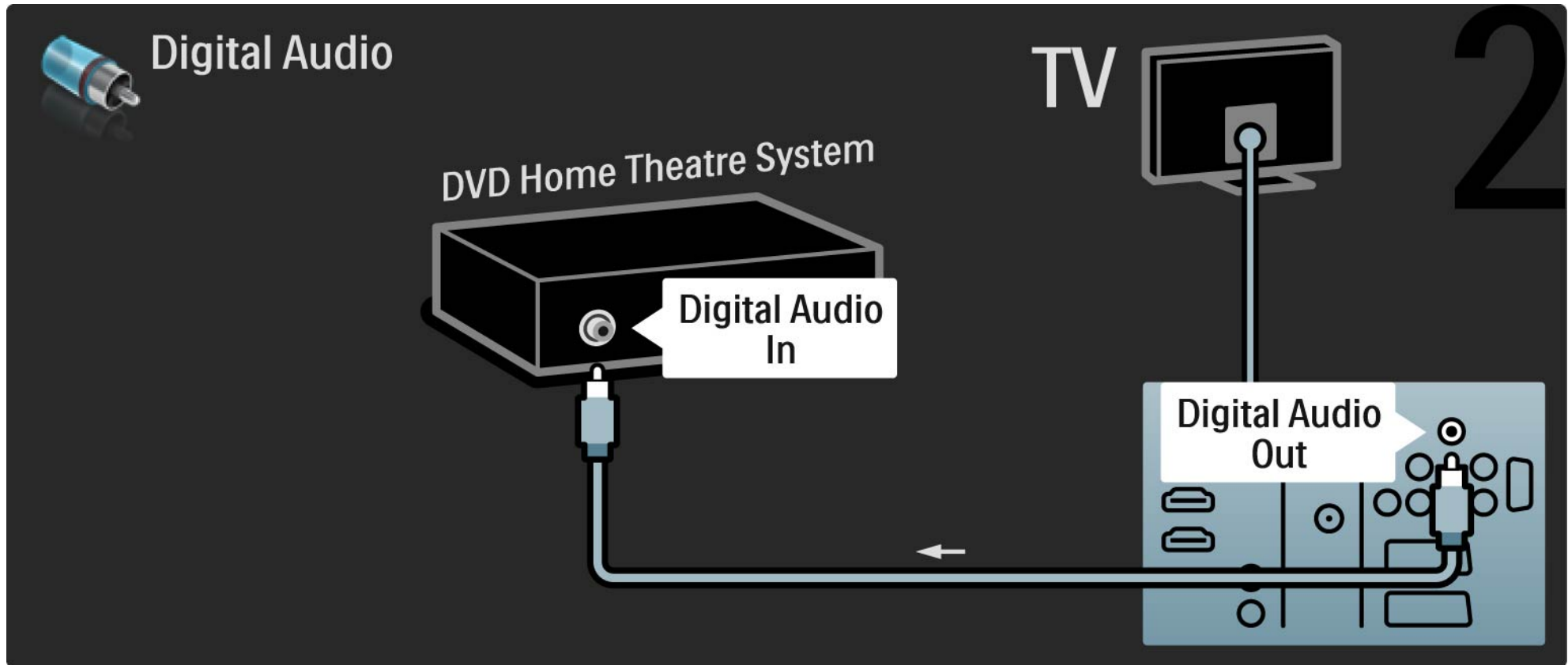

5.3.2 DVD Home Theatre System

3/3

Audio Out L/R

If there is no digital audio output on the Home Theatre System, you can use the TV's analogue Audio Out L/R connection.

Audio and Video synchronisation (sync)

If the sound does not match with the video on screen, you can set a delay on most DVD Home Theatre Systems to match the sound and video.

Do not connect the audio signal from a DVD player or other device directly to the Home Theatre System. Always lead the sound through the TV first.

5.3.3 DVD Recorder

First, use 2 antenna cables to connect the antenna to the DVD Recorder and the TV.

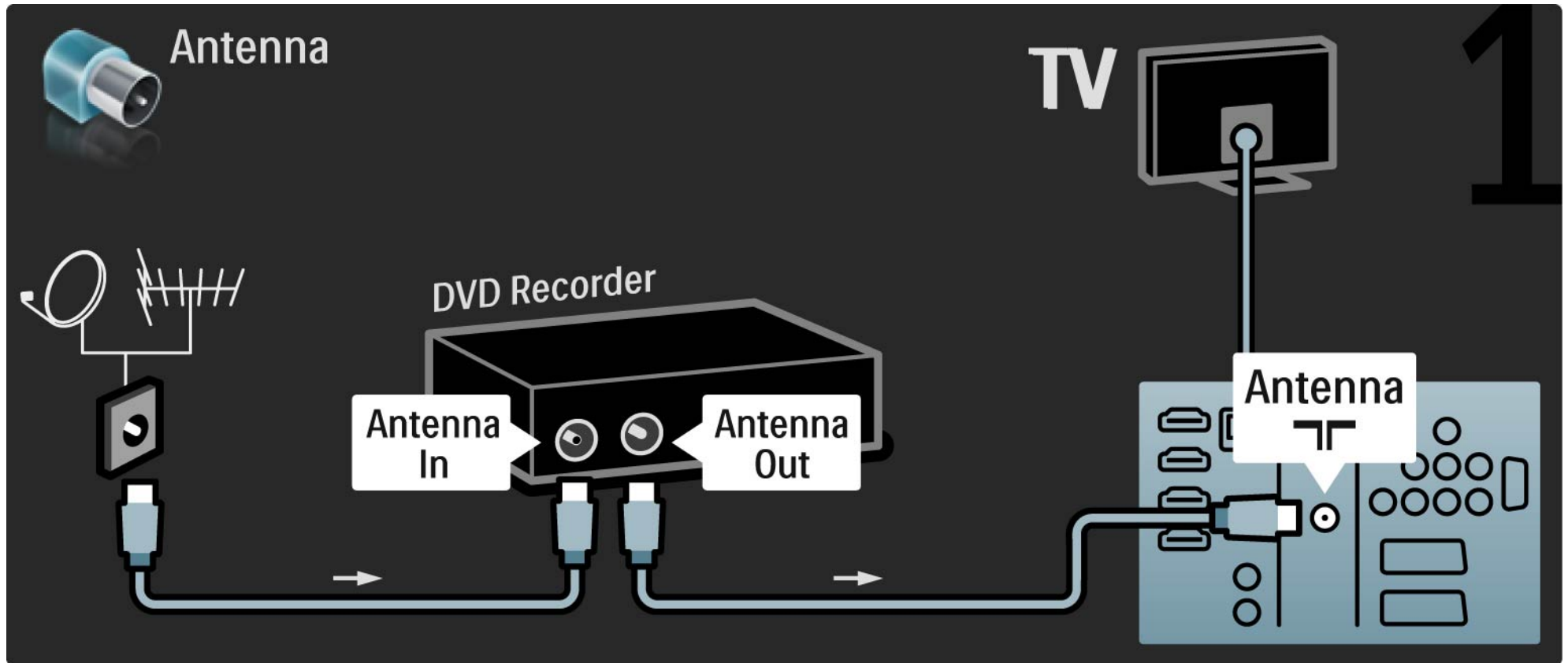

5.3.3 DVD Recorder

Finally, use a scart cable to connect the DVD Recorder to a scart connector on the back of the TV.

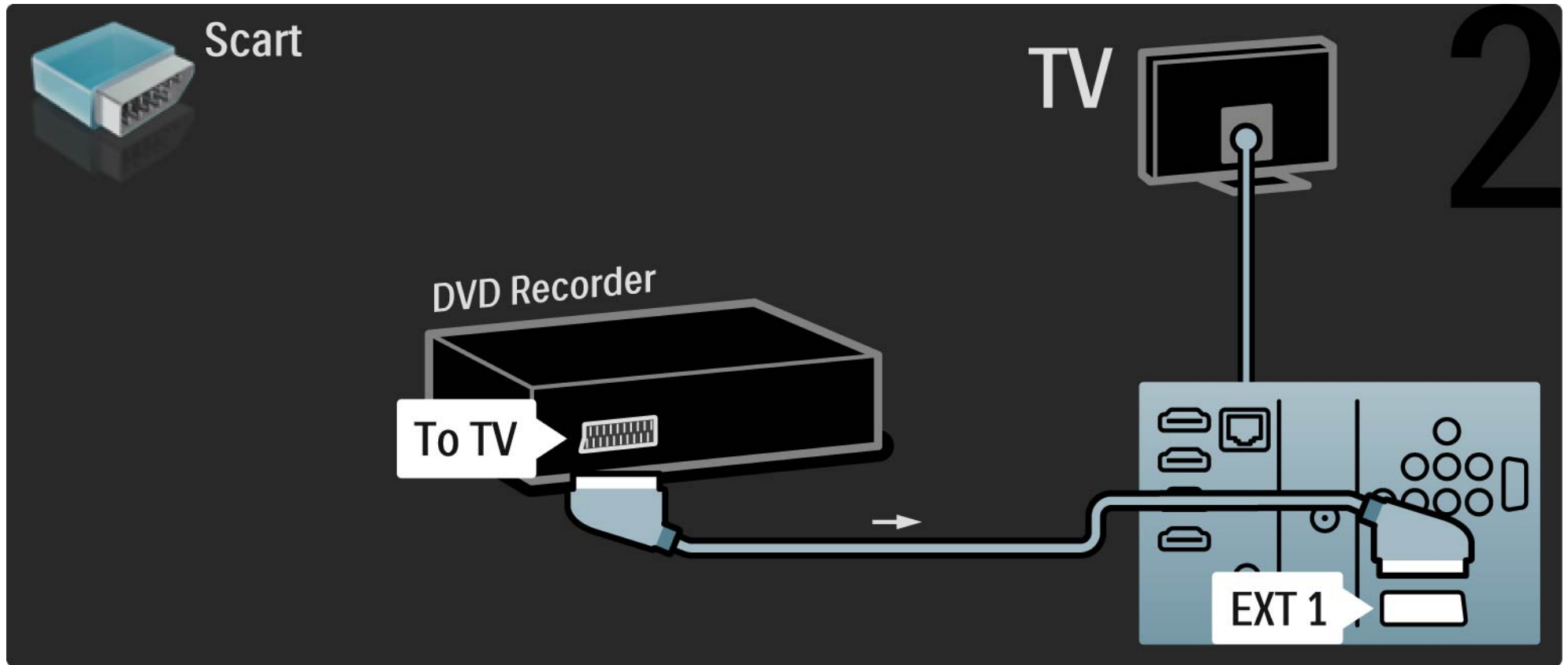

5.3.4 Digital receiver or Satellite receiver

1/2

First, use 2 antenna cables to connect the antenna to the receiver and the TV.

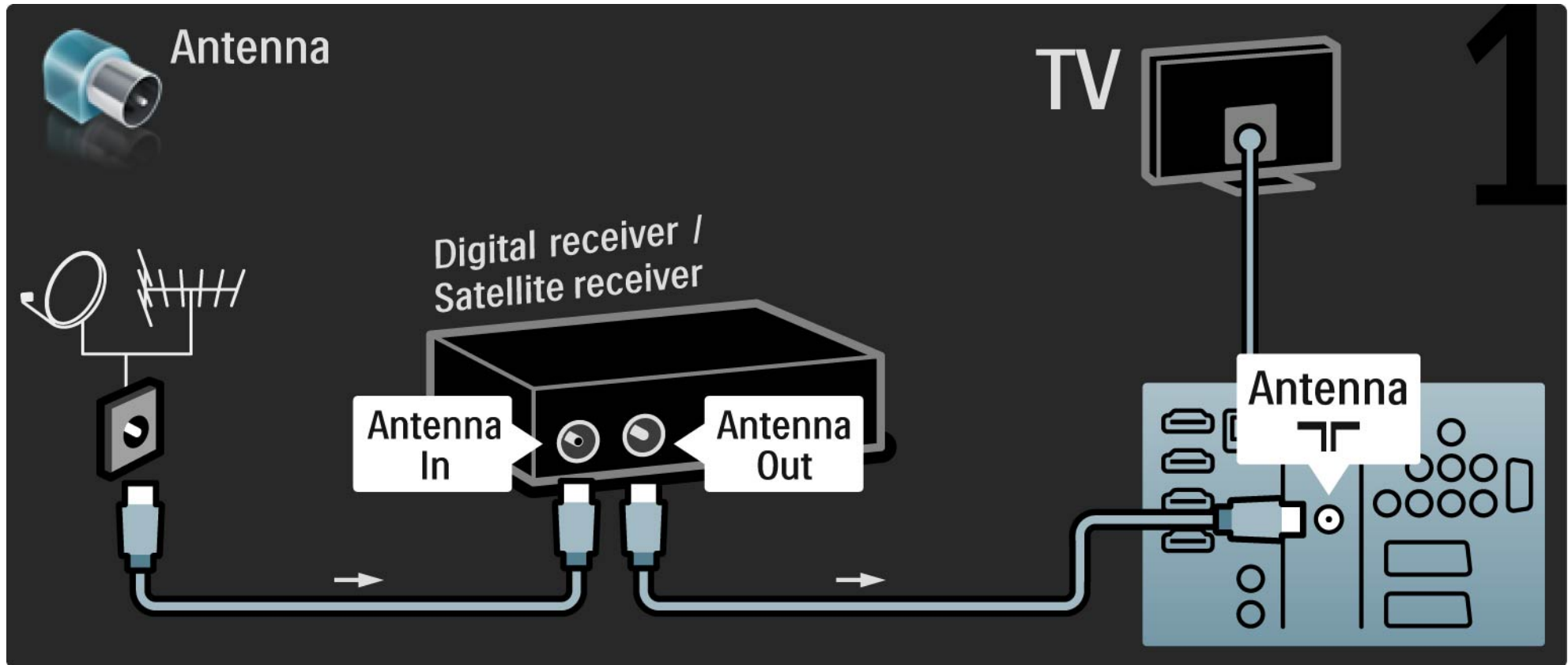

5.3.4 Digital receiver or Satellite receiver

2/2

Finally, use a scart cable to connect the receiver to the back of the TV

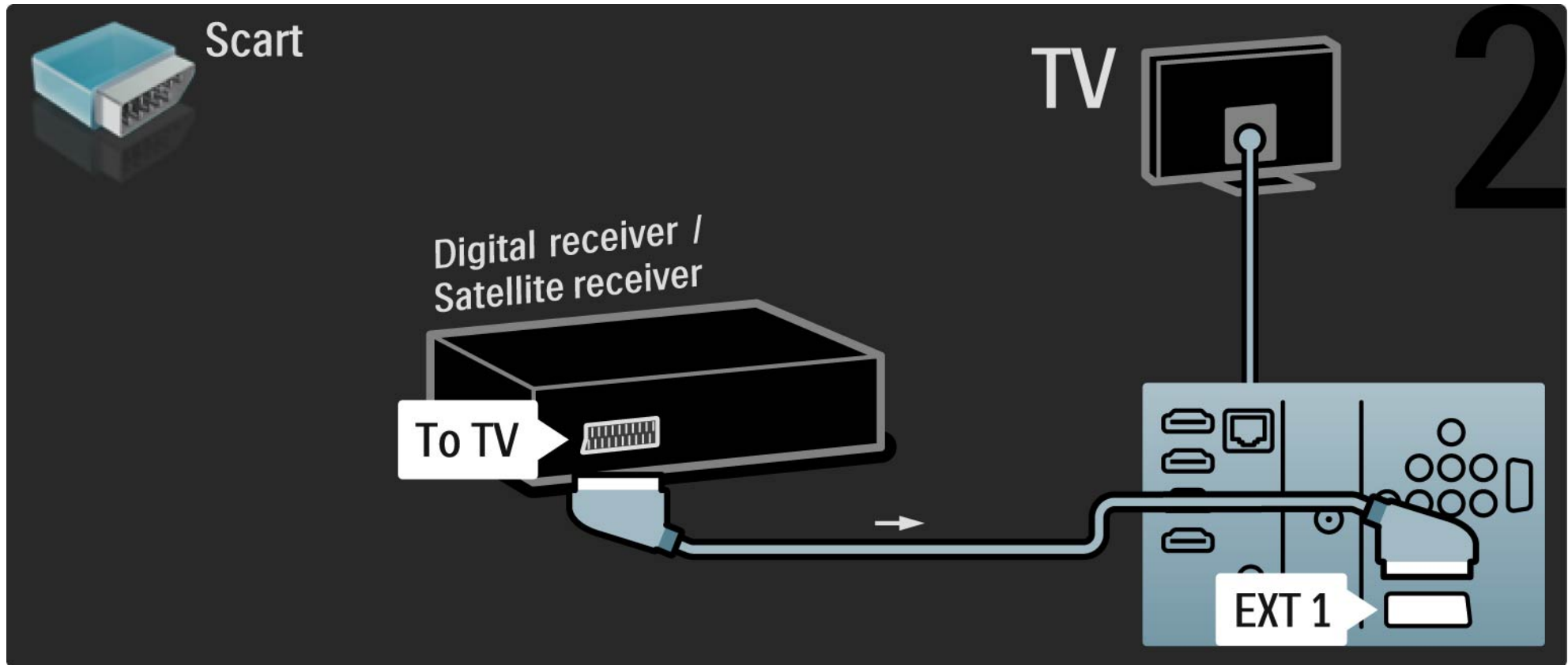

5.3.5 Digital receiver and DVD Recorder

1/3

First, use 3 antenna cables to connect the digital receiver and the DVD Recorder to the TV.

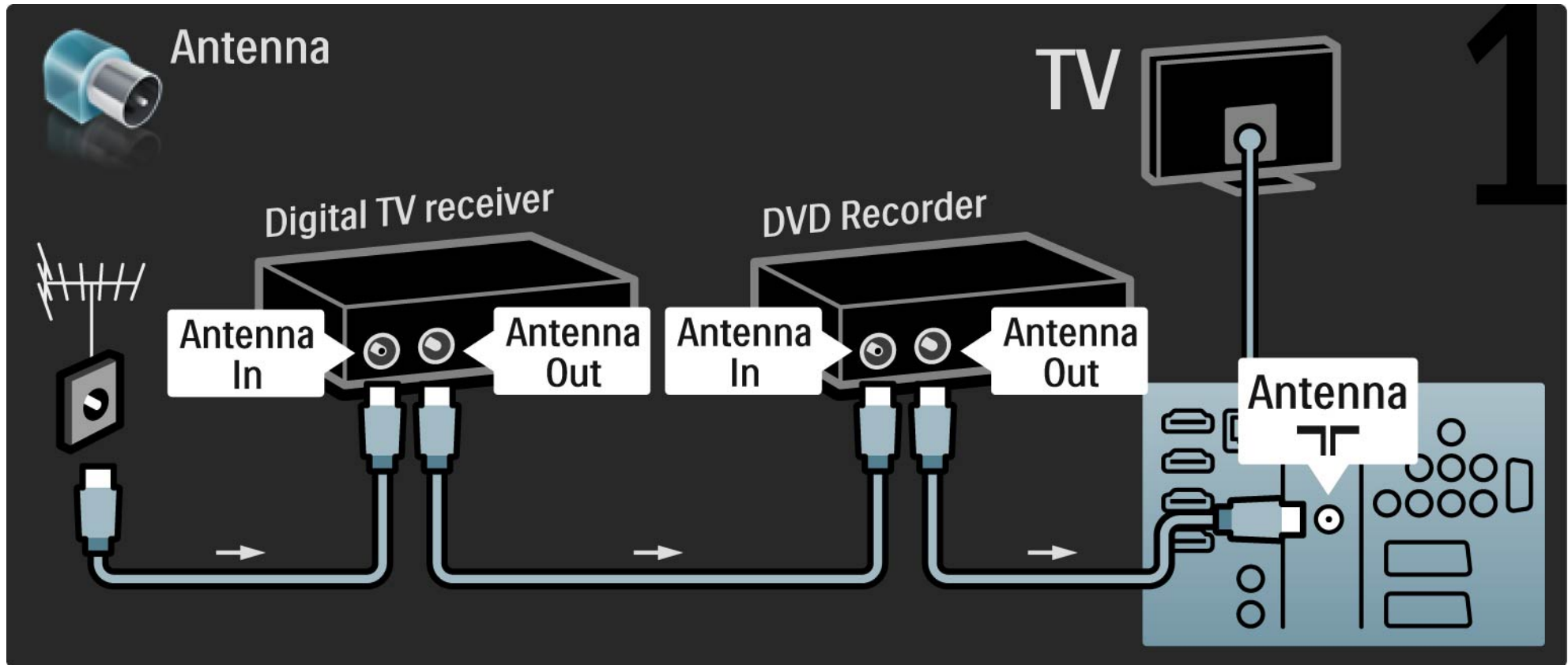

5.3.5 Digital receiver and DVD Recorder

2/3

Then use a scart cable to connect the digital receiver to the TV.

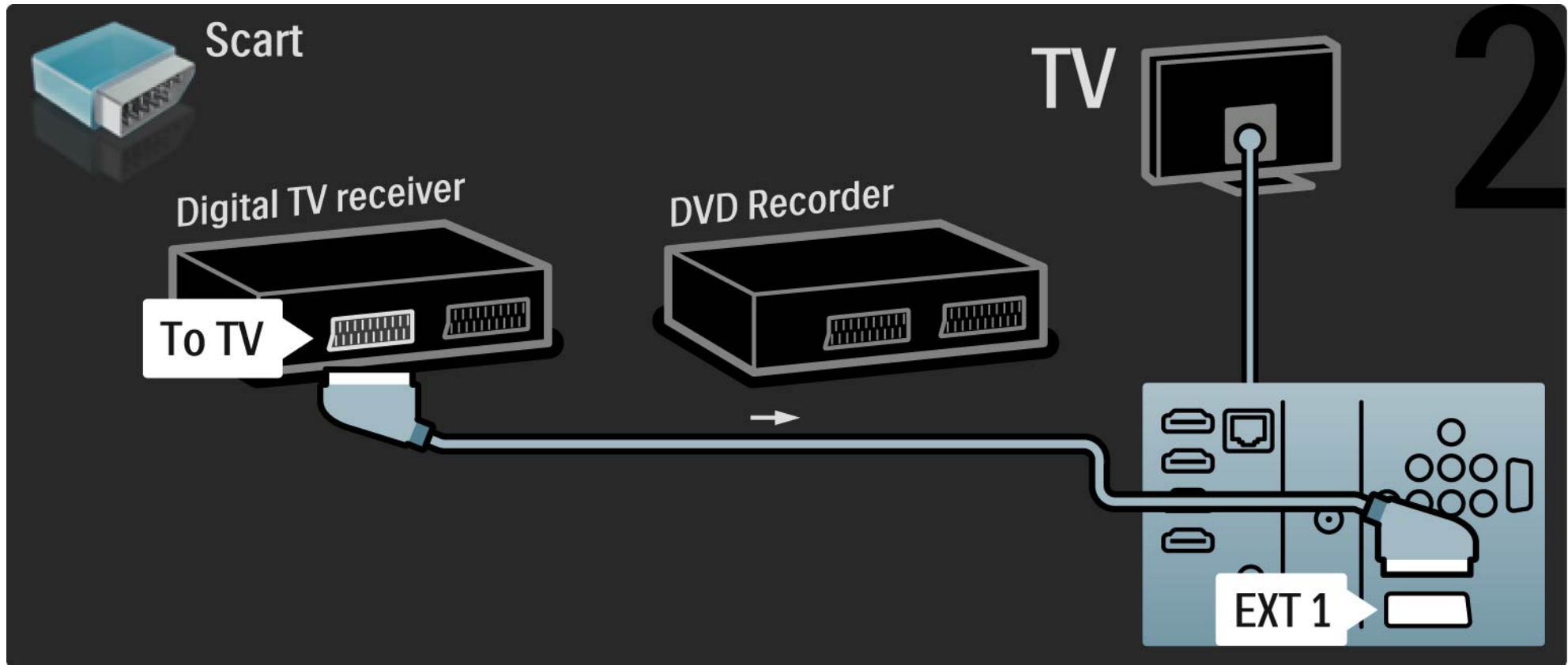

5.3.5 Digital receiver and DVD Recorder

3/3

Finally, use 2 scart cables to connect the 2 devices and the TV.

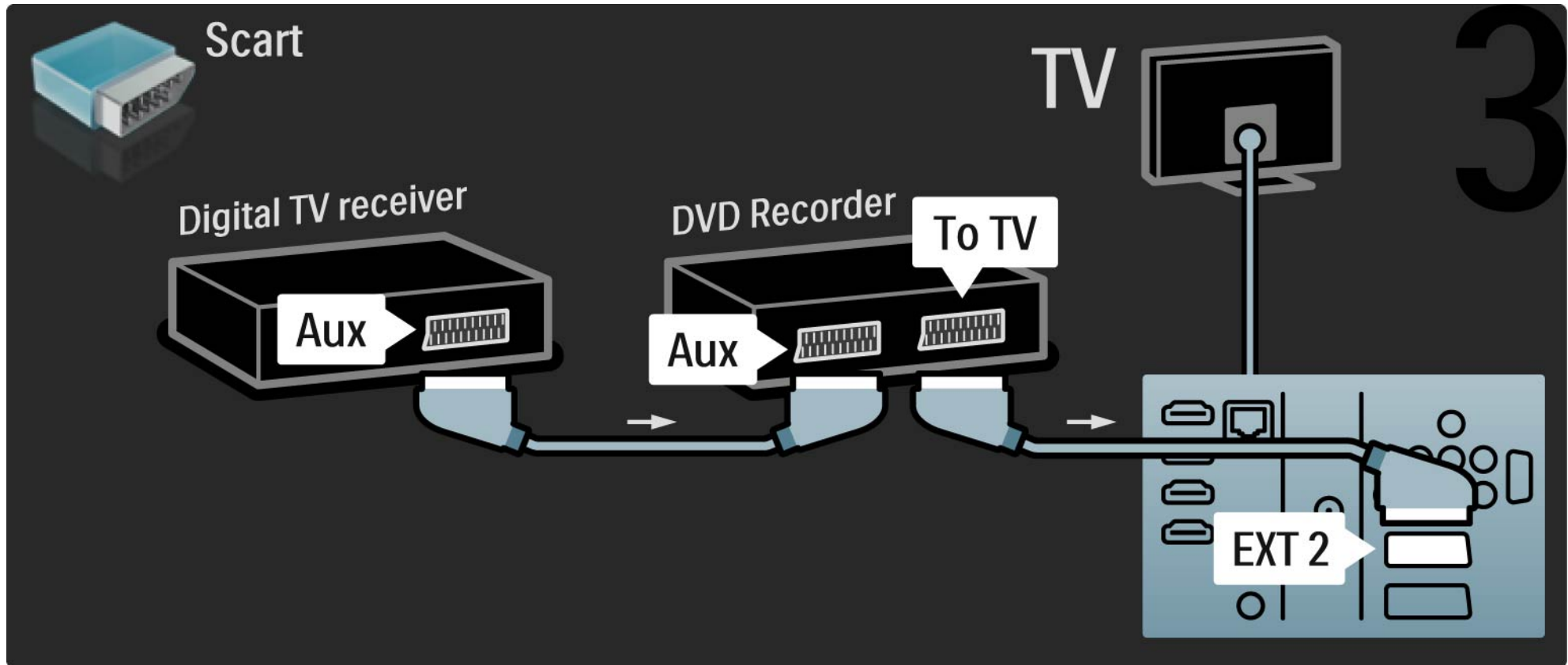

5.3.6 Digital receiver, DVD Recorder and Home Theatre System

1/5

First, use 3 antenna cables to connect the 2 devices and the TV.

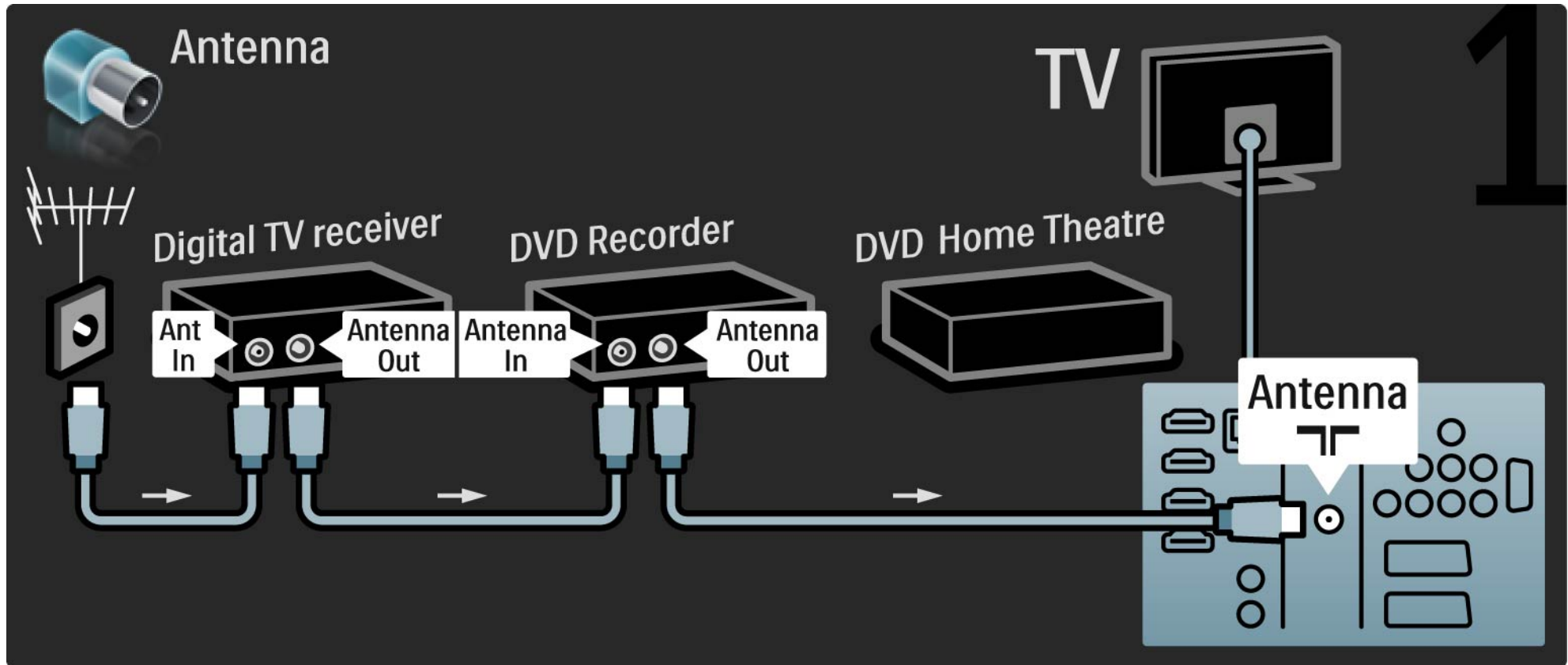

5.3.6 Digital receiver, DVD Recorder and Home Theatre System

2/5

Then use a scart cable to connect the digital receiver to the TV.

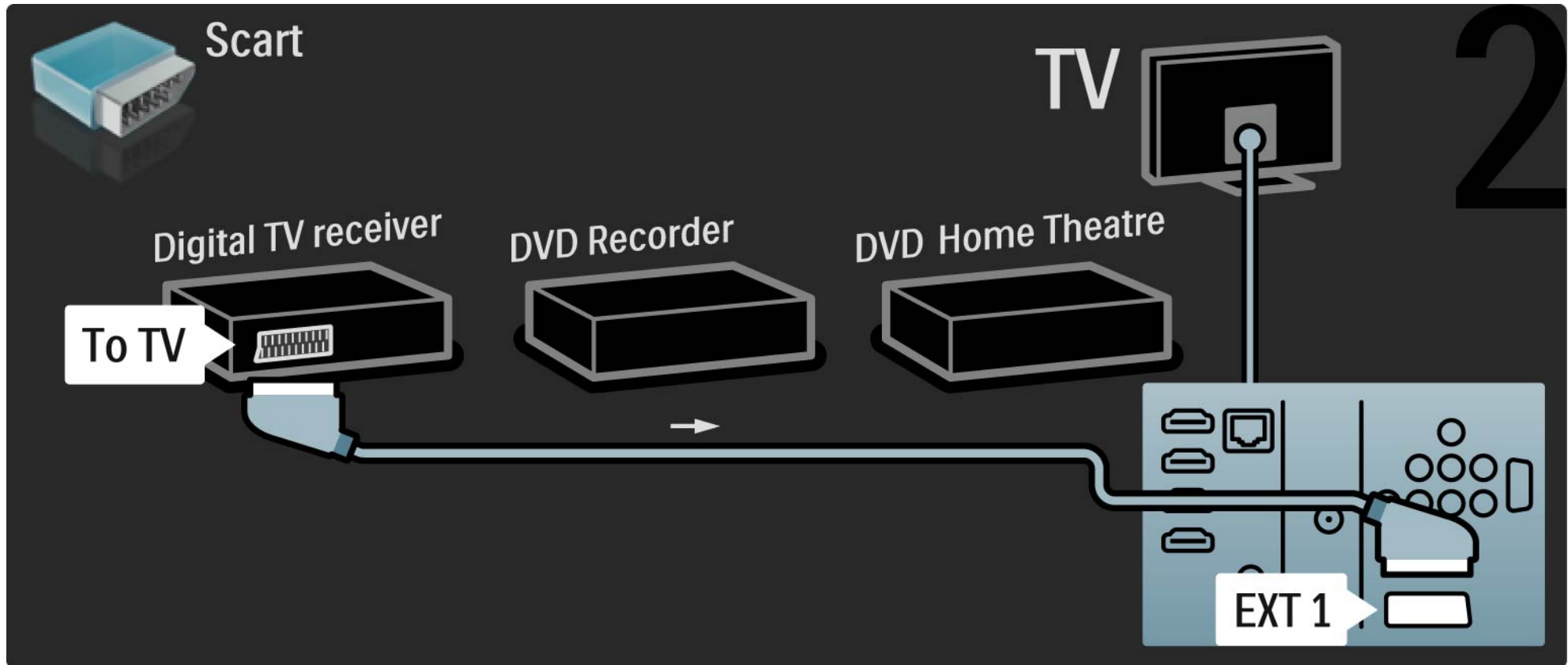

5.3.6 Digital receiver, DVD Recorder and Home Theatre System

3/5

Then use 2 Scart cables to connect the Digital receiver to the DVD Recorder and the DVD Recorder to the TV.

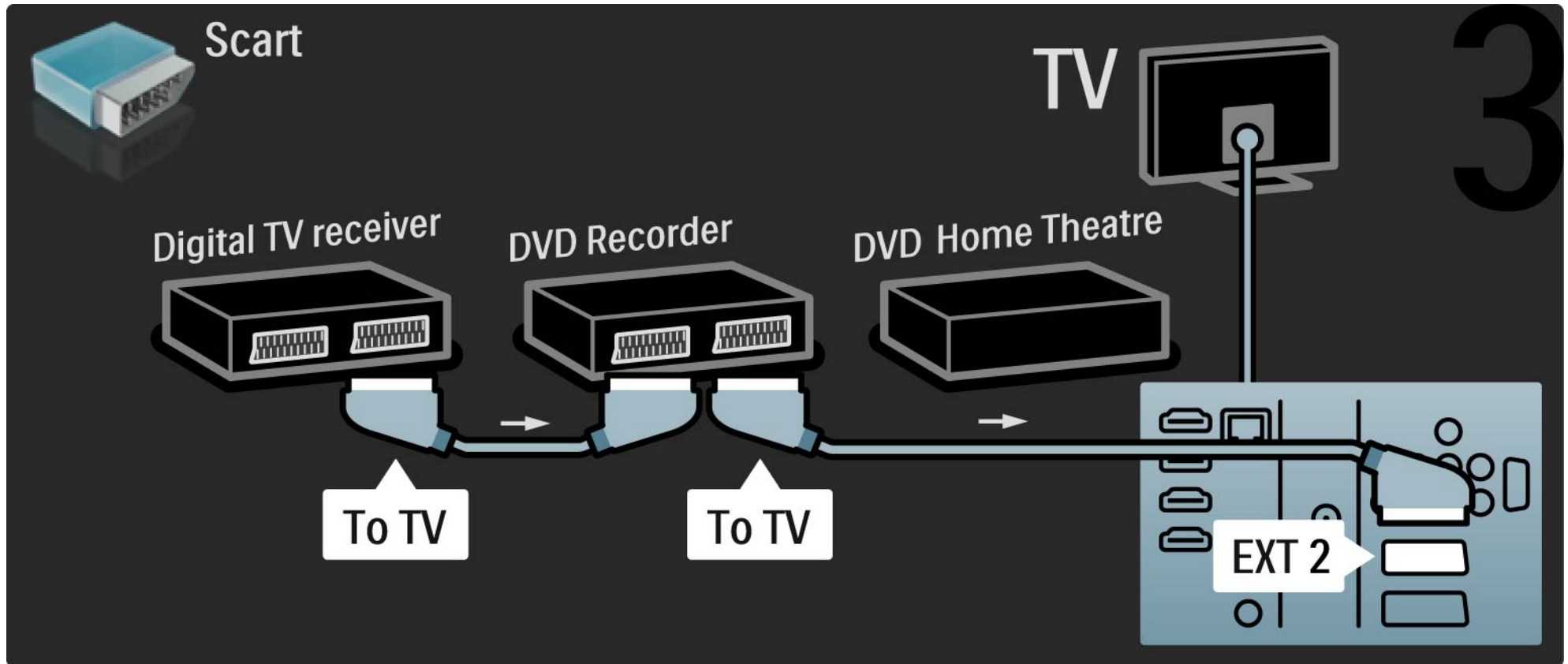

5.3.6 Digital receiver, DVD Recorder and Home Theatre System

4/5

Then use an HDMI cable to connect the Home Theatre System to the TV.

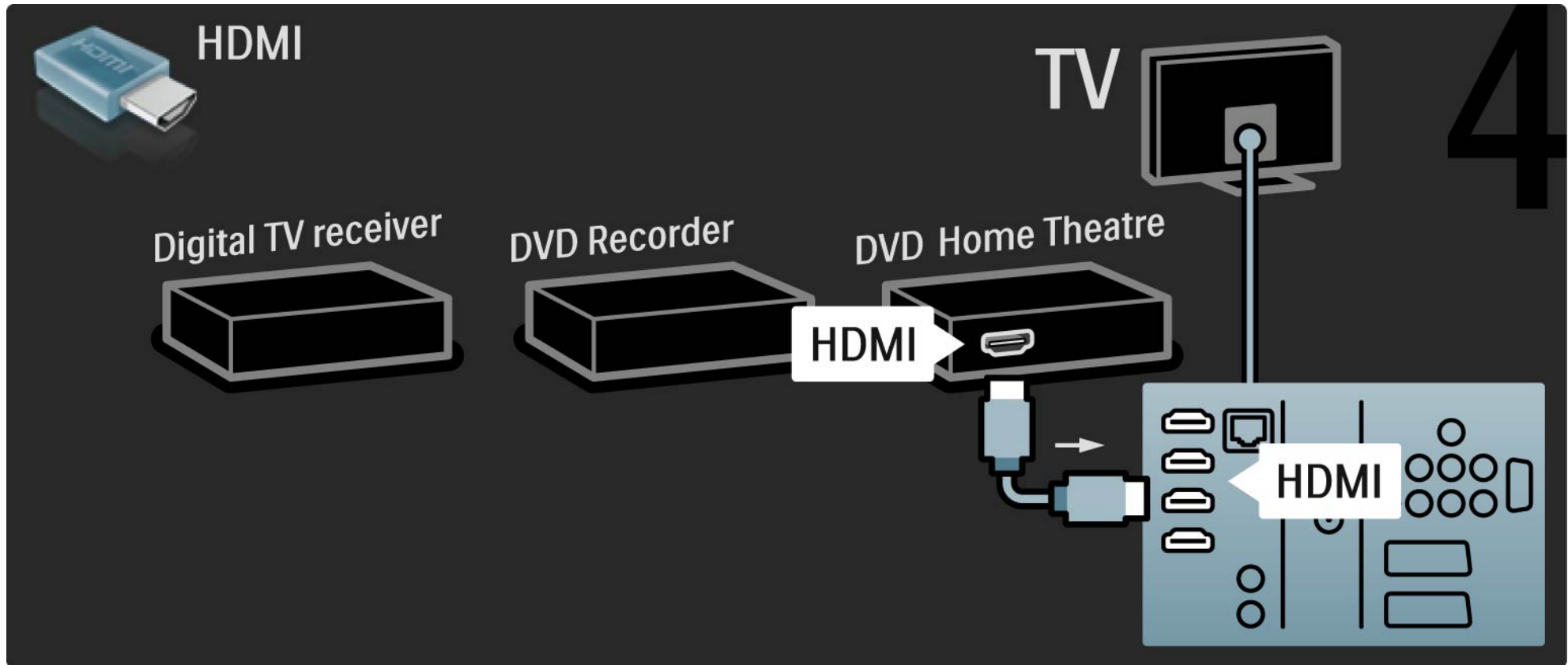

5.3.6 Digital receiver, DVD Recorder and Home Theatre System

5/5

Finally, use a digital audio cinch cable to connect the Home Theatre System to the TV.

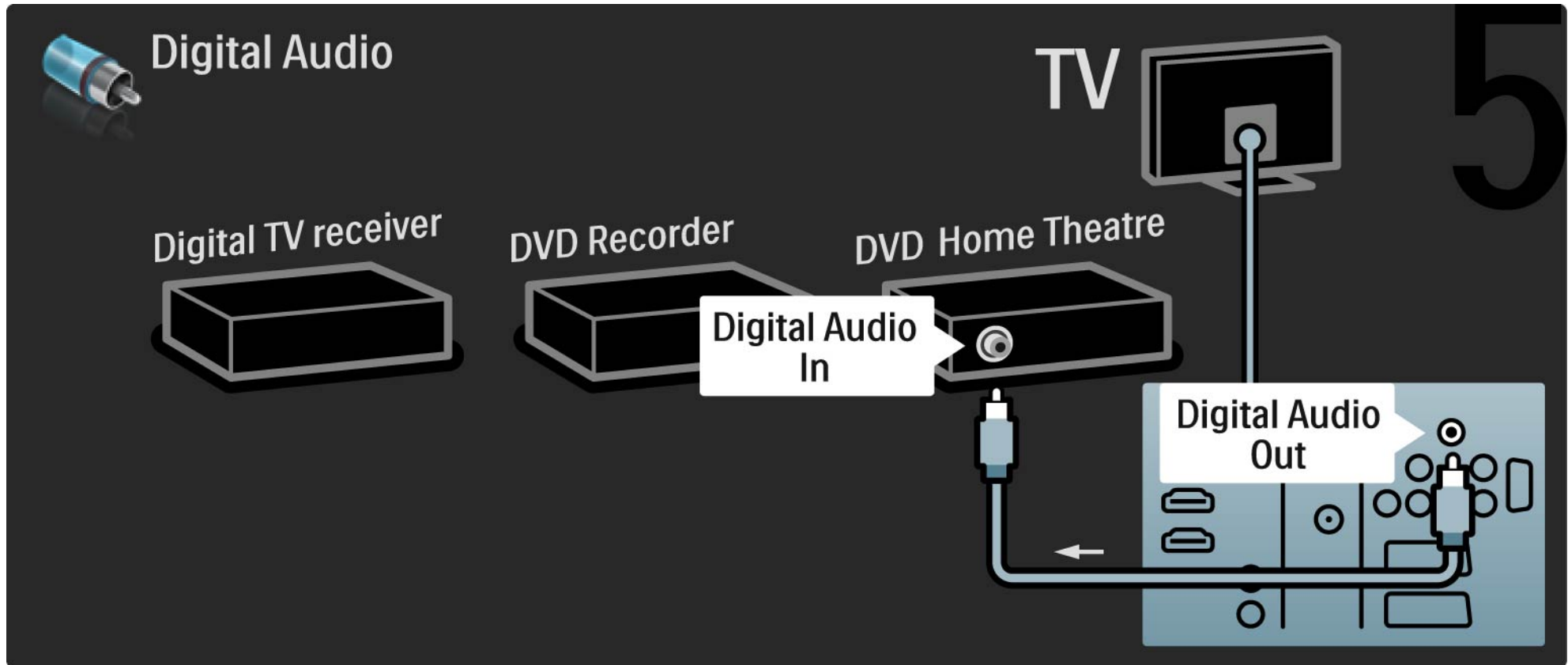

5.3.7 Blu-ray Disc player

Use an HDMI cable to connect the Blu-ray Disc player to an HDMI connector on the back of the TV.

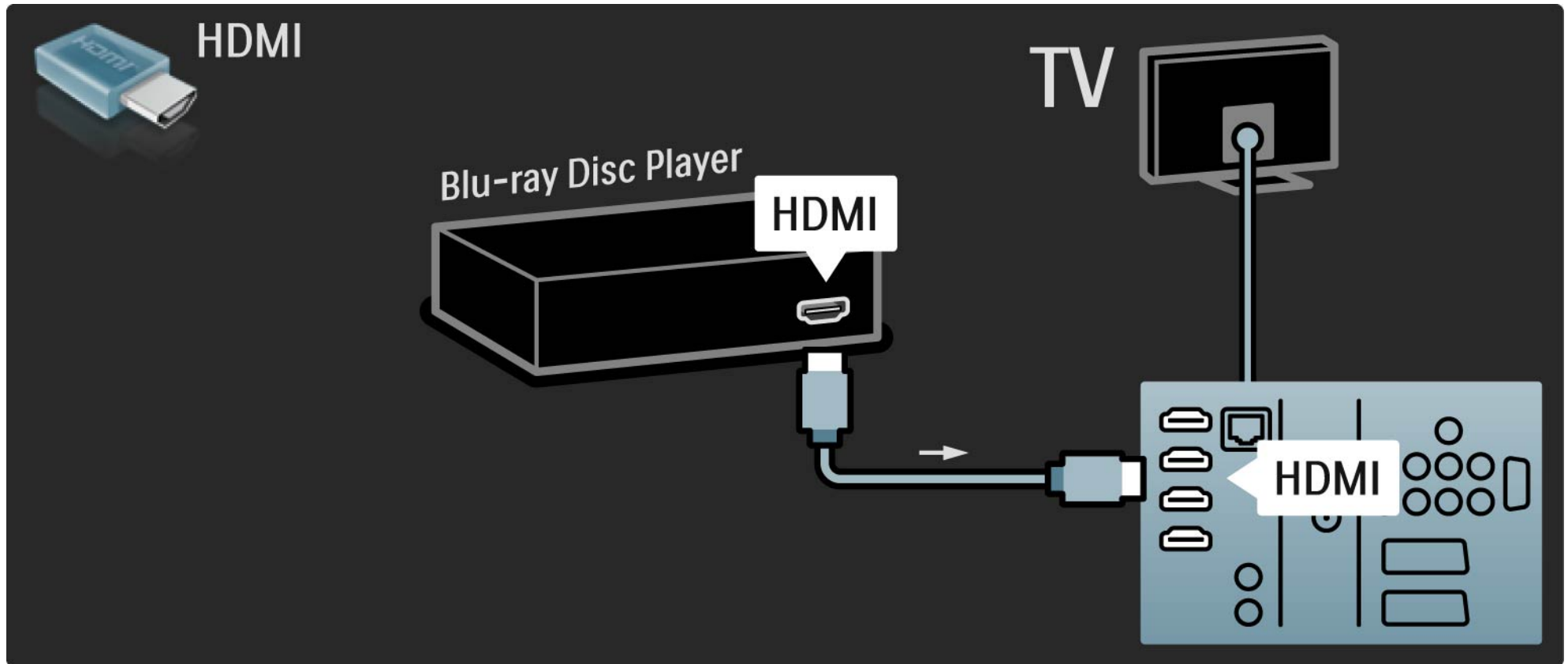

5.3.8 Digital HD receiver

1/2

First, use 2 antenna cables to connect the Digital HD receiver to the TV.

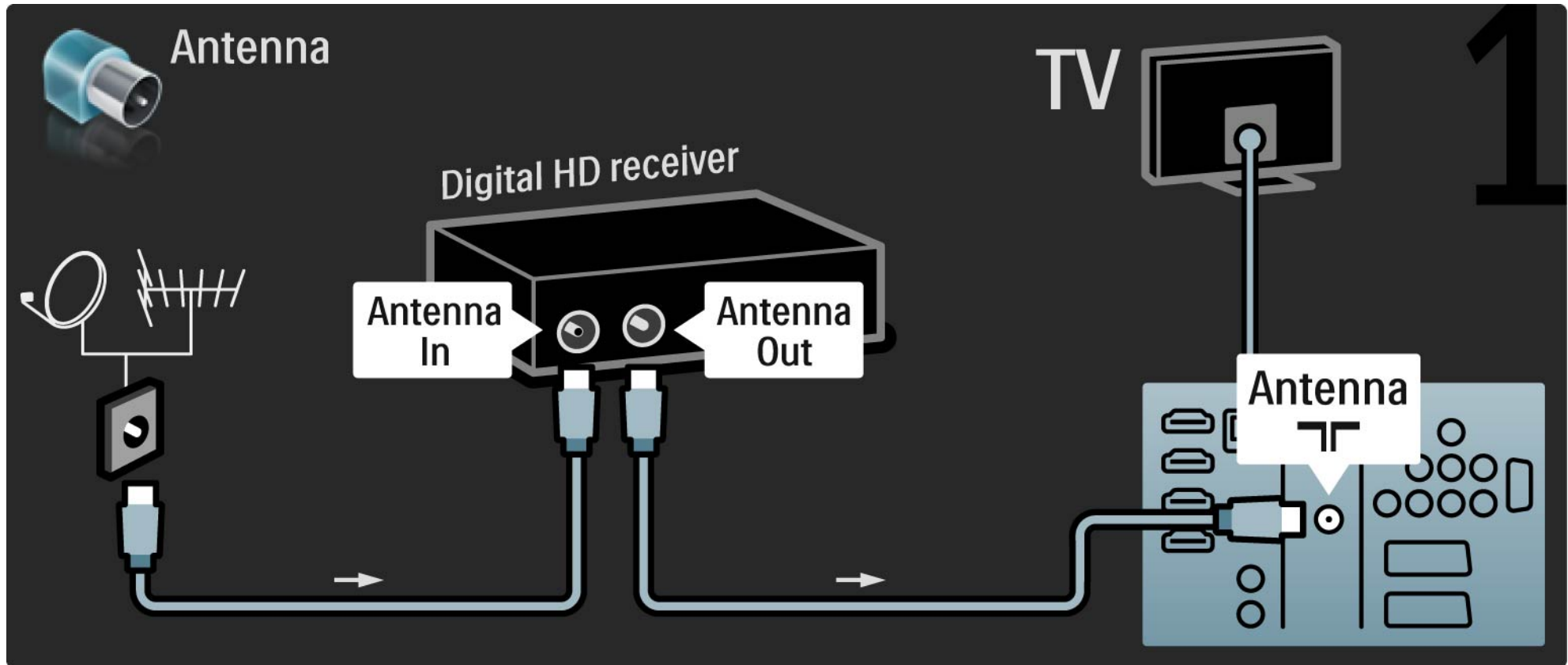

5.3.8 Digital HD receiver

2/2

Use an HDMI cable to connect the Digital HD receiver to the TV.

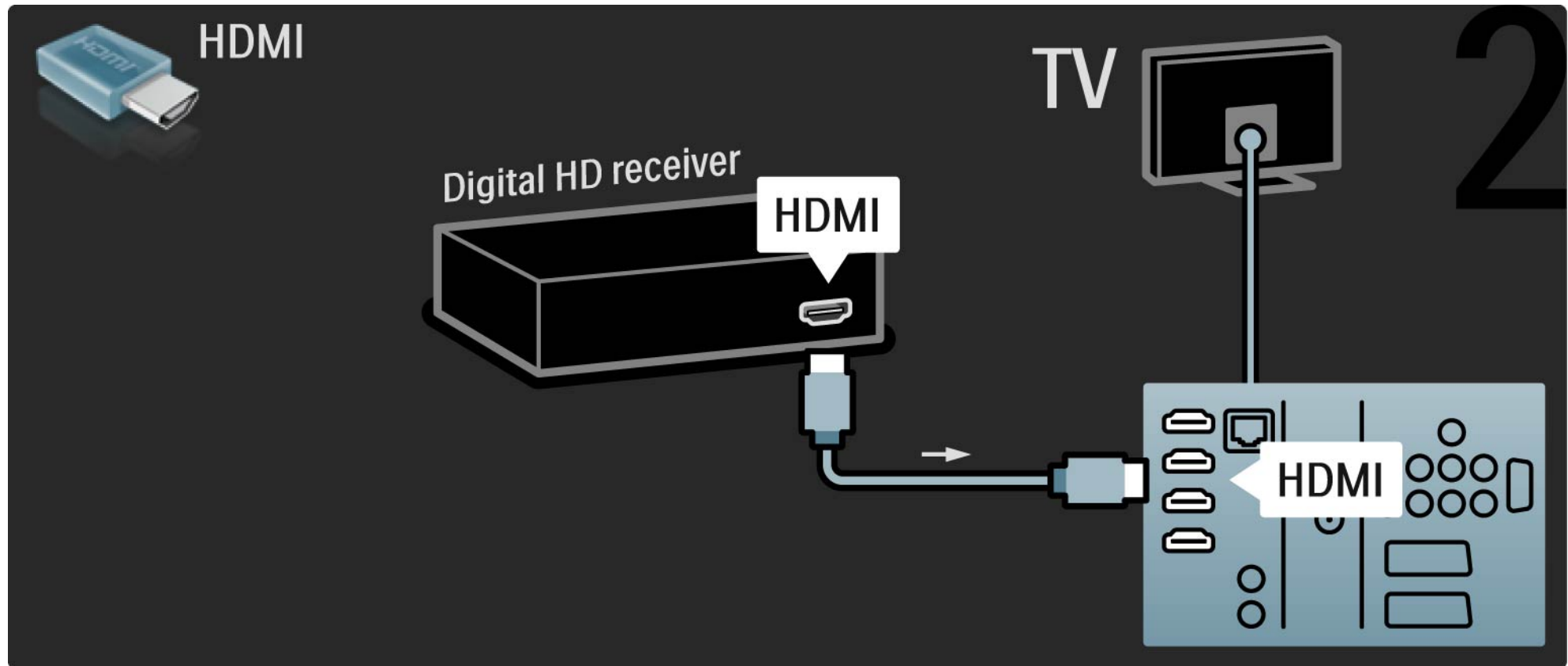

5.4.1 Game console

1/3

Connect a game console to the back of the TV. You can use an HDMI, YPbPr, S-Video or a Video connection. Never connect the S-Video and Video at the same time.

See the next pages for how to connect your games console.

Picture delay

To prevent picture delay, set the TV to Game mode.

Close this user manual and press Options  and select Picture and sound. Press OK.

Select Smart settings and press OK.

Select Game and press OK.

...

5.4.1 Game console

2/3

Use an HDMI cable to connect the game console to the back of the TV.

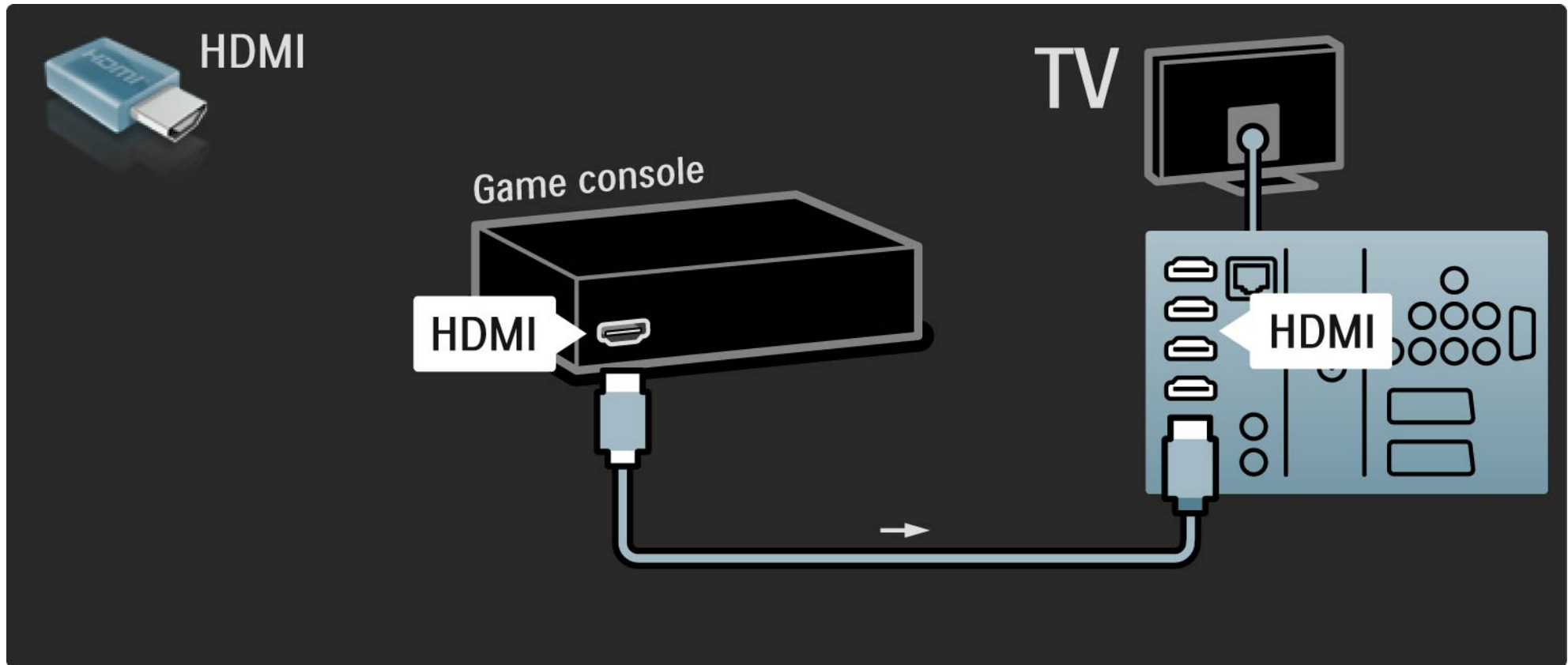

5.4.1 Game console

3/3

Or use a S-video or video cable together with an Audio L/R to connect the game console to the back of the TV.

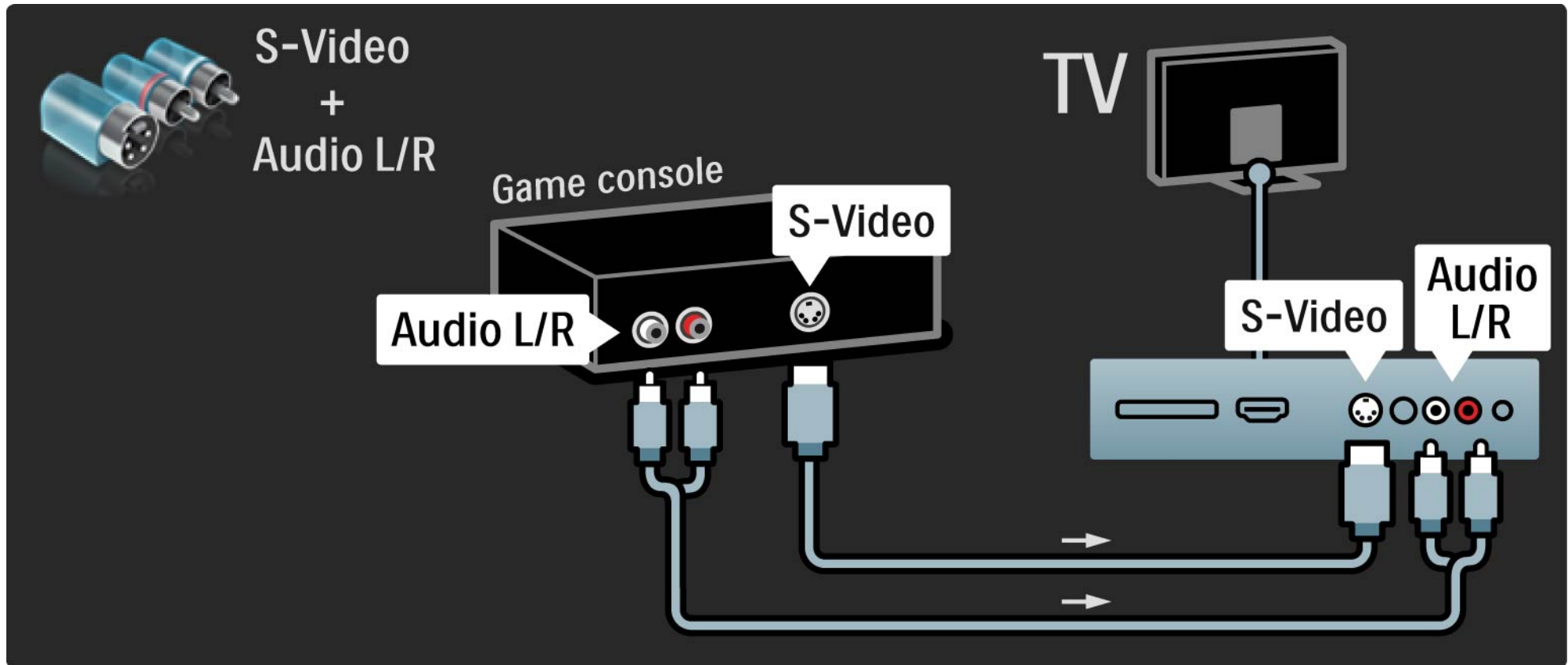

5.4.2 HD Game console

Use an HDMI cable or YPbPr and Audio L/R cables to connect a High Definition game console to the TV.

Read also [Connections > More devices > Game](#).

5.4.3 Photo camera

To view pictures stored on your digital photo camera, you can connect the camera directly to the TV. Use the USB connection at the side of the TV to connect. Switch on the camera after you made the connection.

If the list with the content of the camera does not show automatically, your camera might need to be set to transfer its content with PTP – Picture Transfer Protocol. Read the user manual of the digital photo camera.

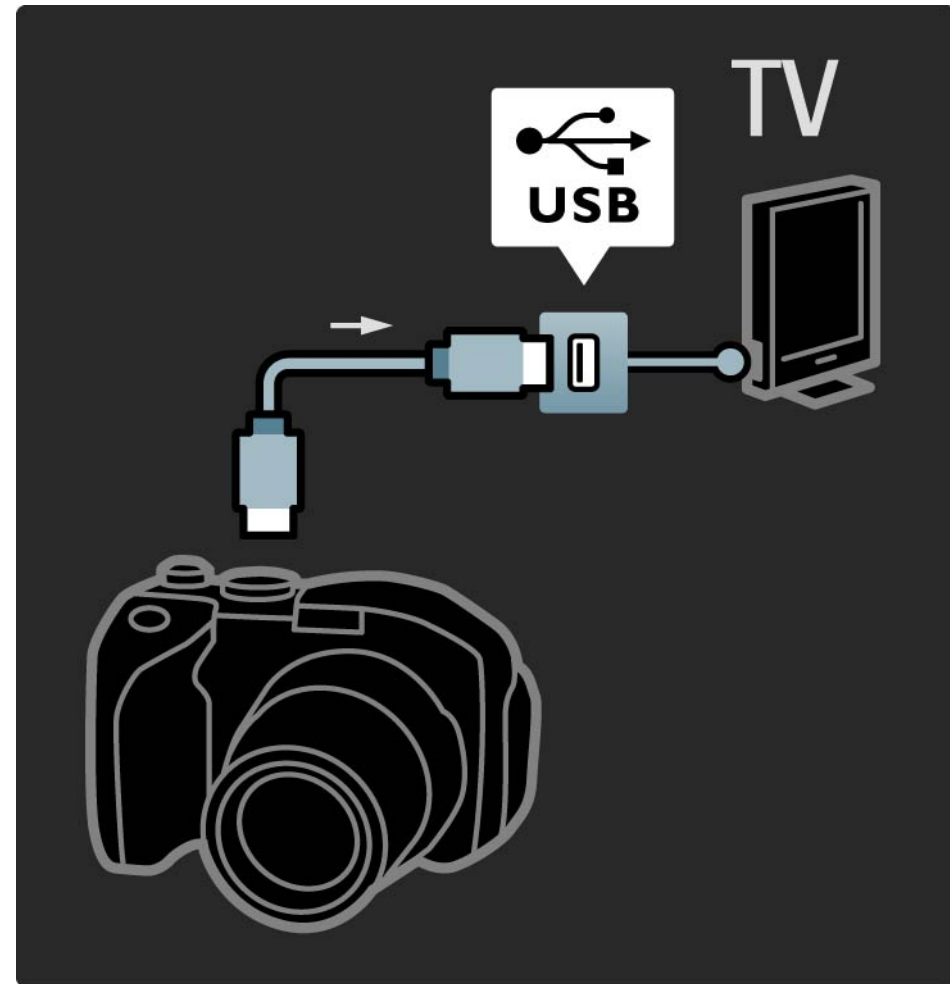

5.4.4 Camcorder

1/3

The most practical connection for a camcorder is at the side of the TV. You can use an HDMI, S-Video or Video connection but never connect the S-Video and Video at the same time.

See the next pages for how to connect your camcorder.

...

5.4.4 Camcorder

2/3

Use an HDMI cable to connect the camcorder to the back of the TV.

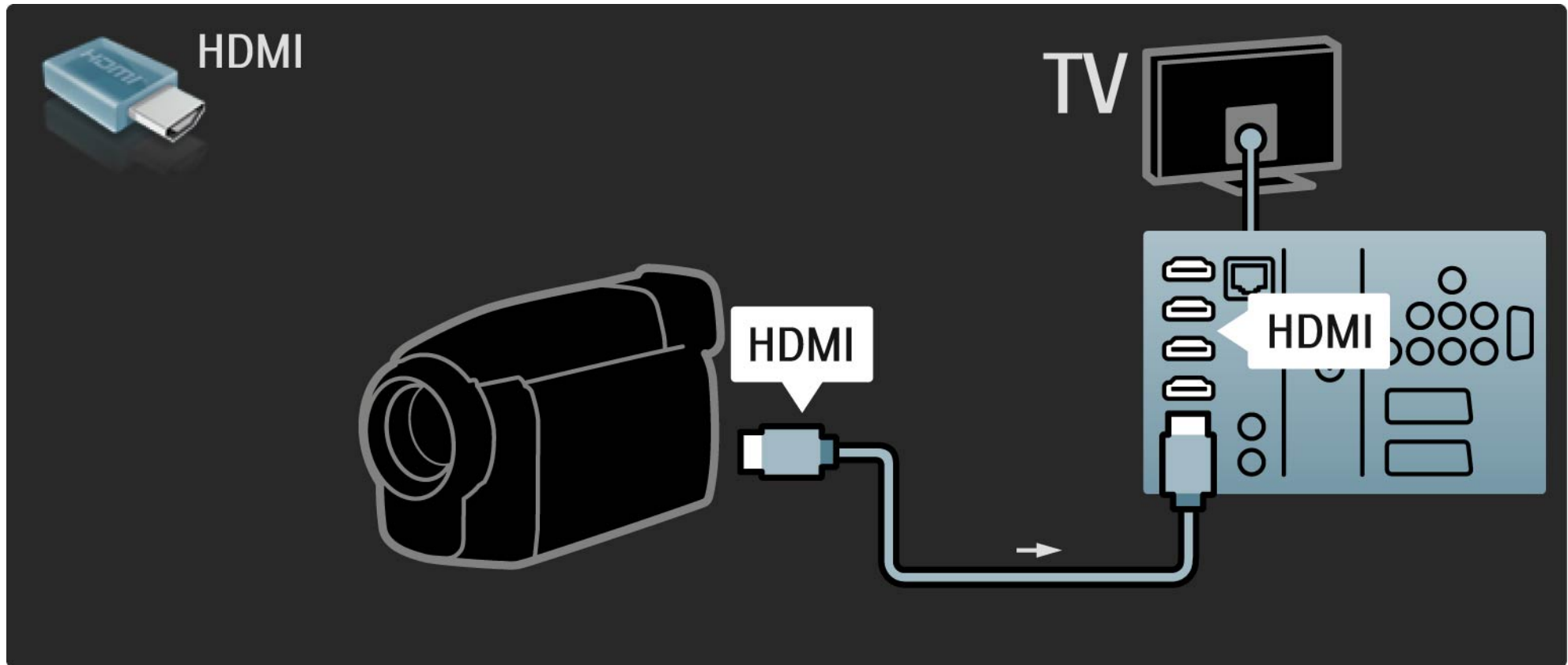

5.4.4 Camcorder

3/3

Or use a S-video or video cable together with an Audio L/R to connect the camcorder to the back of the TV.

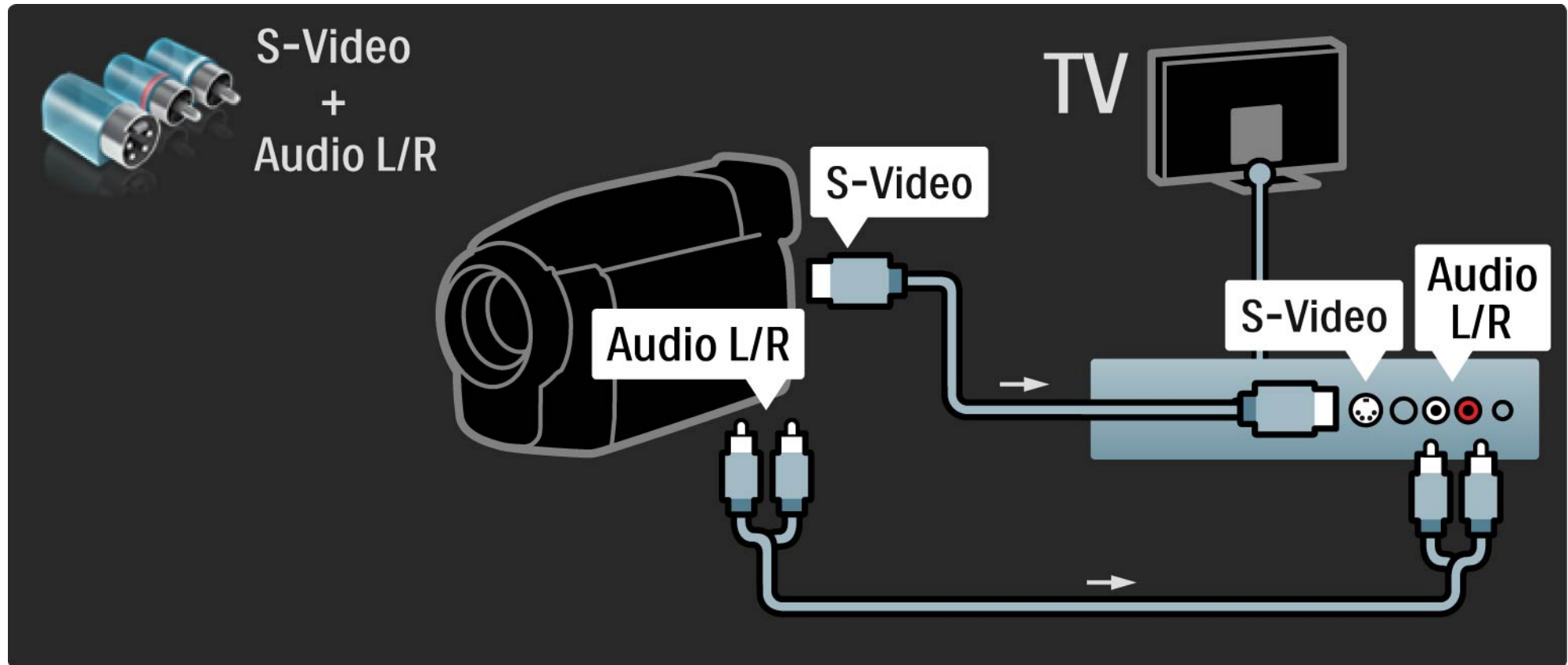

5.4.5 TV as PC monitor

1/3

You can connect the TV to your computer as a PC monitor.

Before connecting the PC, set the PC monitor refresh rate to 60 Hz.

You can connect the PC to the side of the TV or alternatively to the back. See the next pages to connect your computer.

Ideal TV setting

Set the TV Picture format to Unscaled for the sharpest picture quality. While watching TV, press Options , select Picture format and select Unscaled.

Supported PC resolutions

For a list of supported resolutions see [Technical data > Display resolutions](#).

...

5.4.5 TV as PC monitor

2/3

Use a DVI to HDMI adapter to connect the PC to HDMI and an audio L/R cable to connect the Audio L/R to the back of the TV.

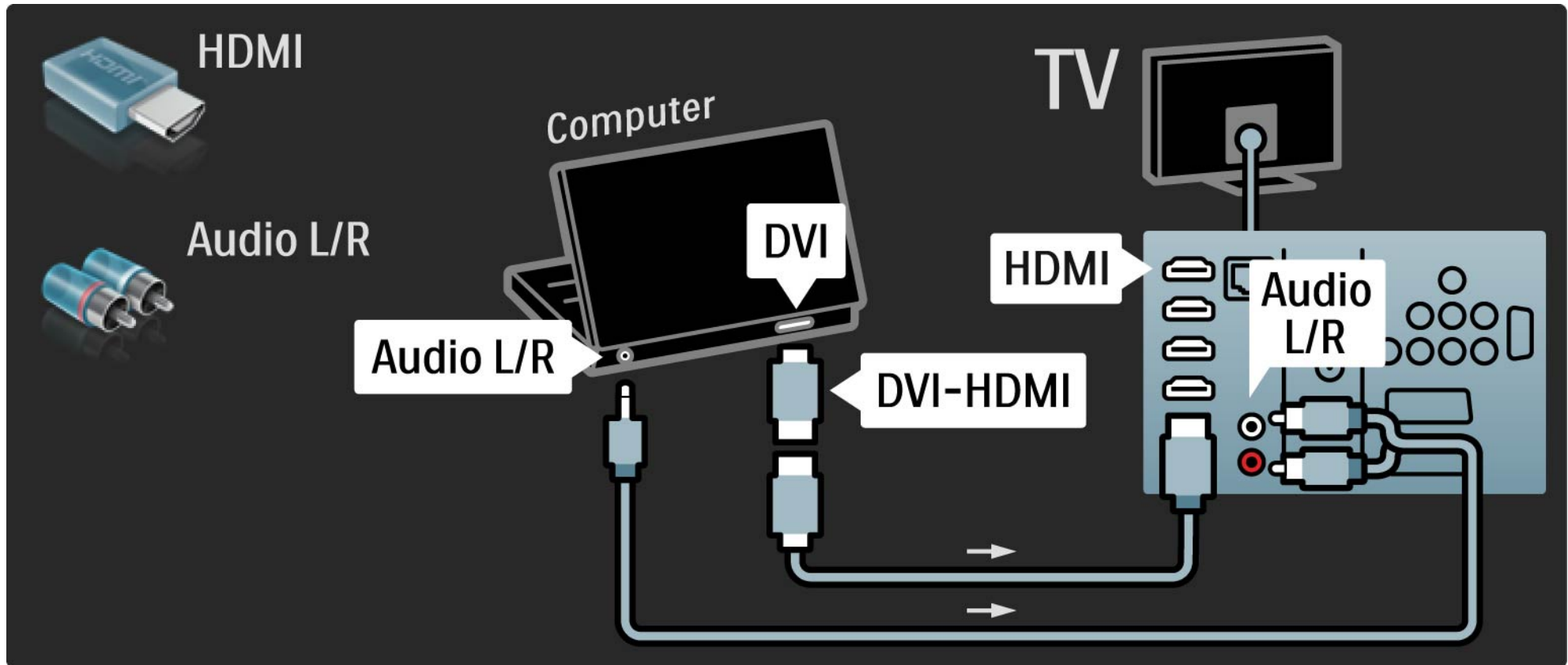

5.4.5 TV as PC monitor

3/3

Use a VGA cable to connect the PC to the VGA connector and an audio L/R cable to connect the VGA Audio L/R to the back of the TV.

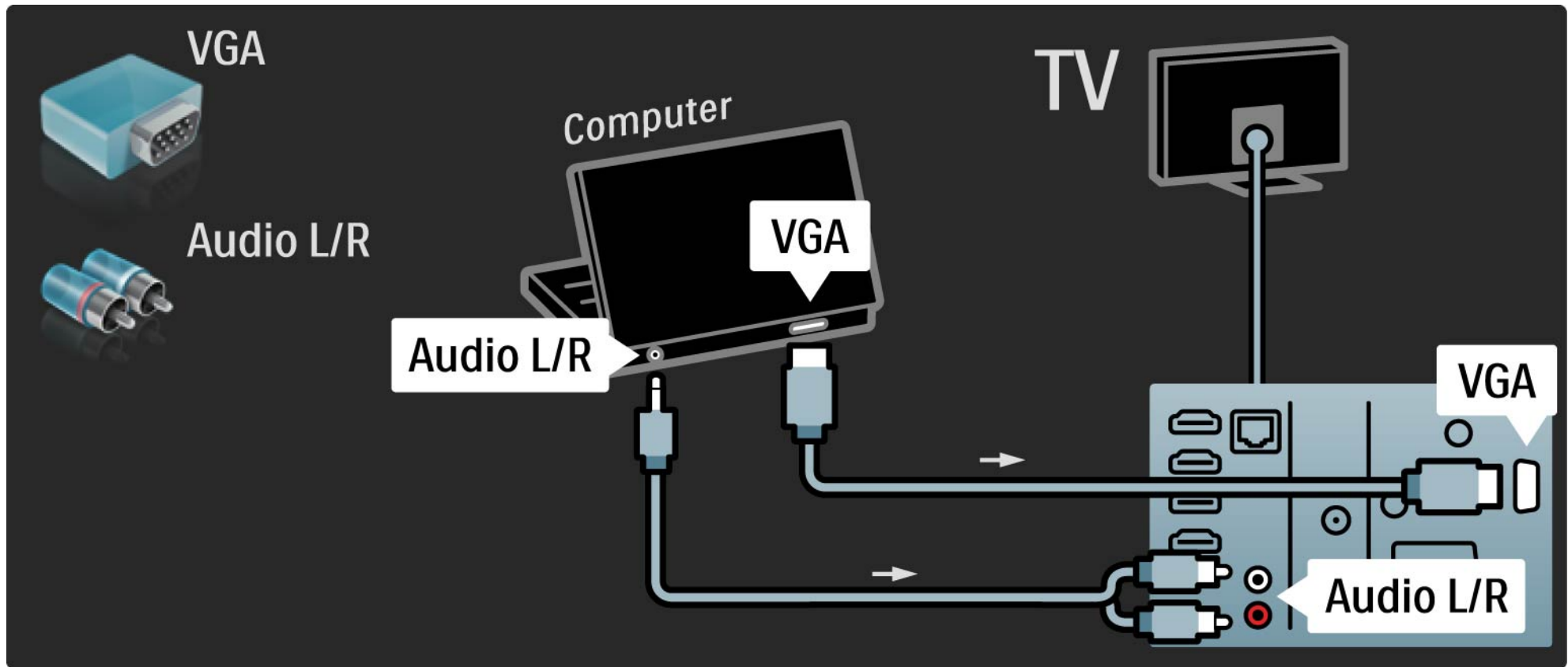

5.4.6 Decoder

Use a scart cable to connect a decoder which decodes analogue antenna channels. Use the EXT1 or EXT2 connectors at the back of the TV.

You have to assign the TV channel as a channel to be decoded. Then assign the connection where the decoder is connected.

Close this user manual and press  > Setup > Installation > Decoder. Select Channel to set the channel that you want to decode. Select Status to set the connector you use for the decoder.

5.5.1 EasyLink

1/2

If a device is equipped with the HDMI-CEC standard, the device and the TV can work together.

Connect the TV to the device using an HDMI cable. The TV comes with EasyLink set to On. To switch EasyLink off, press  > Setup > Installation > Preferences > EasyLink.

With EasyLink, the following functions are available:

- One touch play

Insert a disc and press Play on the device. The TV switches on from standby mode and shows the disc programme automatically.

- System standby

Press  on the TV remote control for 2 seconds to switch the connected devices into standby mode.

...

5.5.1 EasyLink

- System audio control

If you connect an audio system, you can listen to the audio from the TV through the audio system. The TV speakers are muted automatically.

The TV comes with the speakers set to EasyLink (Automatic). To switch the TV speakers off or permanently on, press  > Setup > Sound > TV speakers.

Make sure that all HDMI-CEC settings are properly set up on the device . EasyLink might not work with devices from other brands.

Naming of HDMI-CEC on other brands

The HDMI-CEC functionality has different names with different brands. Some examples of name are: Anynet, Aquos Link, Bravia Theatre Sync, Kuro Link, Simplink, Viera Link, ...

Not all brands are fully compatible with EasyLink.

5.5.2 EasyLink Remote Control

First read Connections > EasyLink, before you go on with EasyLink Remote control.

With EasyLink Remote control, the TV remote control commands are sent directly to the device you are watching on TV. There is no need to select the device on the remote control first.

Caution> This is an advanced setting. Verify if all devices are suited for this setting. Unsited devices will not respond. Try out this function first, before you switch on EasyLink Remote control permanently.

To switch EasyLink Remote control on, press  > Setup > Installation > Preferences > EasyLink Remote control.

Except for the Home  key, all remote control commands will try to operate the device. Some commands might not work with the device.

To switch back to TV control, press  and select Watch TV

To control another device, press  and select the other device.

5.6.1 Conditional Access Module (CAM)

1/2

Scrambled digital TV channels can be decoded with a Conditional Access Module (CAM). Digital TV service operators provide the CAM when you subscribe to their services. Contact a digital TV service operator for more information and terms & conditions.

Insert a CAM

Switch off the TV before inserting a CAM.

Look on the CAM for the correct method of insertion. Incorrect insertion can damage the CAM and the TV.

Look for the common interface slot on the side of the TV. Gently insert the CAM as far as it will go and leave it in the slot permanently.

It can take a few minutes before the CAM is activated. Removing the CAM will deactivate the service on TV.

...

5.6.1 Conditional Access Module

2/2

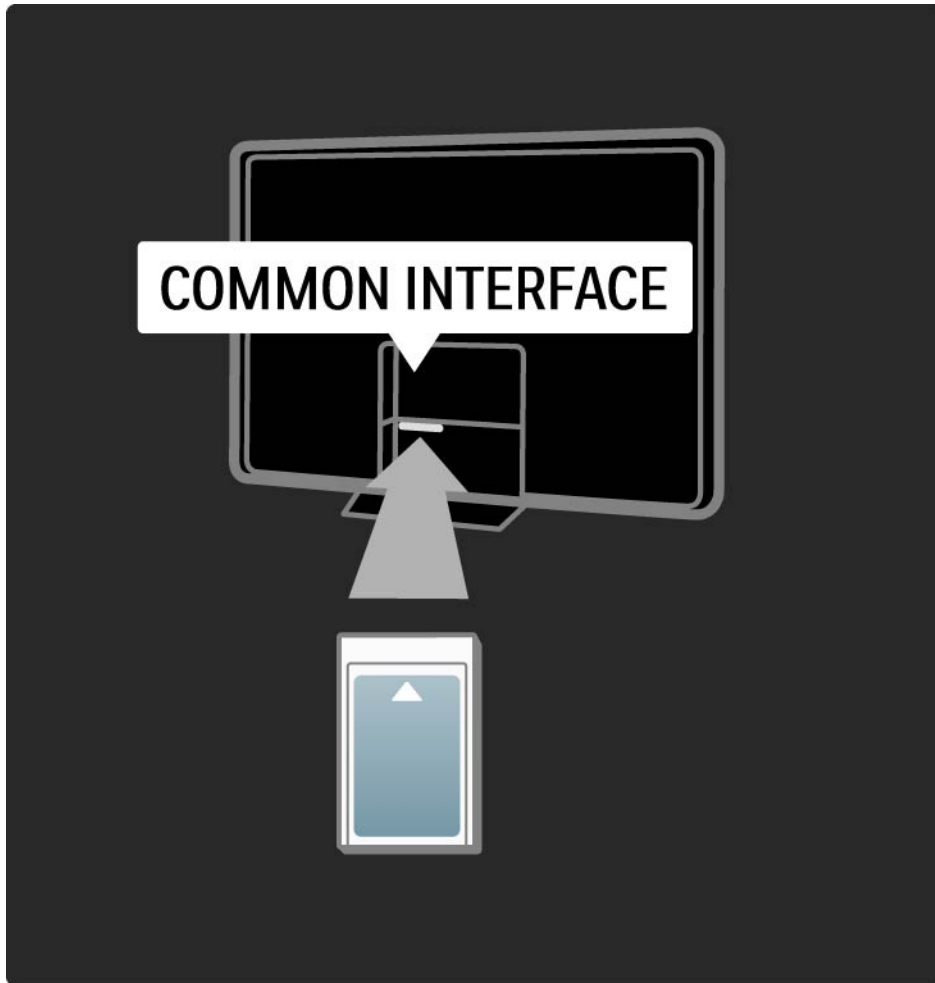

Watching a CAM service

If a CAM is inserted and subscription fees have been paid, the TV shows the programme from the digital TV service provider. The applications, their function, the content and the onscreen messages all come from the CAM service.

CAM settings

To set passwords or PIN codes for the CAM service, press **Home** > Setup > Features > Common Interface. Select the CAM provider and press OK.

5.6.2 Common Interface Plus CI+

This TV can handle the CI+ conditional access.

CI+ allows service providers to offer premium HD digital programmes with a high level of copy protection.

To insert a CI+ CAM, read the chapter CAM - Conditional Access Module.

5.7.1 Wireless network connection

To set up the wireless network connection, read all chapters in Setup > Network.

5.7.2 Wired network connection

To set up the wired network connection, read all chapters in Setup > Network.

Connect the router to the TV using a network cable and switch on the router before you start the network installation.

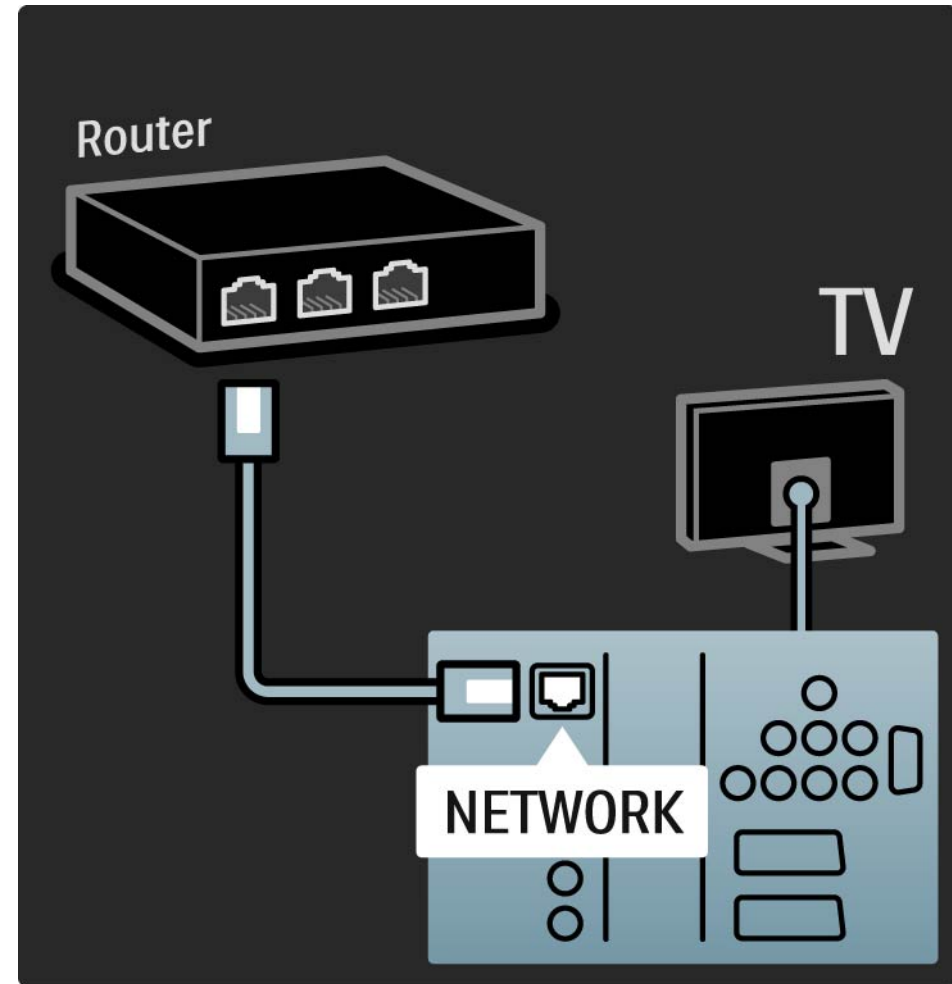

6.1 Contact information

Warning

If your TV breaks down, NEVER try to repair the TV yourself.

If the advice and suggestions in Troubleshooting do not help resolve the problem, try switching the TV off and back on again.

Contact information — Consumer Care

If the TV problem is not solved you can call the Philips Consumer Care hotline in your country. Find the telephone number on the printed documentation that came with the TV.

Or consult our website www.philips.com/support

TV model number and serial number

Find these numbers on the packaging label or on the type label on the back or bottom of the TV.

6.2 TV and remote control

1/2

The TV does not switch on

- Verify the power cable connection.
- Verify that the batteries of the remote control are not empty or weak. Verify their + / - orientation.
- Unplug the power cable, wait for a minute and plug it back in. Try switching it on again.
- You can use the buttons on the TV to switch the TV on.

The TV does not respond to the remote control

- Verify that the batteries of the remote control are not empty or weak. Verify their + / - orientation.
- Clean the remote control and TV sensor lens.
- Verify if EasyLink Remote control is set to Off
- During the warming-up time of the TV, which is about two minutes, it is possible that the TV and some external devices do not immediately respond to commands from the remote control. The device is functioning normally and is not broken.

...

6.2 TV and remote control

2/2

The TV switches off and the red light blinks

- Unplug the power cable, wait a minute and plug it back in. Verify if there is enough space for ventilation. Wait until the TV has cooled down.

If the TV does not restart from standby and the blinking occurs again, call Consumer Care.

You forgot your code to unlock Child lock

- Read Timers and locks > Child lock.

6.3 TV channels

Some TV channels are gone

- Verify if the correct list for the Channel overview is selected. Read Use your TV > Menus > Channel overview.
- A channel could be hidden in the Channel overview. Read Use your TV > Menus > Channel overview.

No digital channels found during installation

- Verify if the TV supports DVB-T or DVB-C in your country. Check the 'Digital TV Country Compatibility' sticker on the back of the TV.

6.4 Picture

1/3

LightGuide is on but there is no picture

- Verify if the antenna is connected properly.
- Verify if the correct device is selected.

The sound is on, but there is no picture

- Verify the contrast or brightness setting in the menu.

The TV picture is poor

- Verify if the antenna is connected properly.
- Non-earthed audio devices, neon lights, high buildings or mountains can influence the picture quality. Try to improve the picture by changing the position of the antenna or placing devices away from the TV.
- Verify that the correct TV system is chosen in the Manual installation menu.
- If only a certain channel is poor, try to fine tune this channel with the Fine tune menu. Read Setup > Installation > Analogue: manual installation.

...

6.4 Picture

The picture has poor colour

- Verify the colour settings in the Picture menu. Select any of the Smart settings in the Setup menu.
- Verify the connections and cables of the connected devices.

Picture delay when a game console is connected

- To prevent picture delay, set the TV to game mode. Select Game in the Smart settings in the Setup menu.

The TV does not remember my settings when I switch it back on

- Check whether the TV is set to Home in the Home menu > Setup > Installation > Preferences > Location menu.

The picture does not fit the screen; it is either too big or too small

- Press  and select a more fitting picture format in the Picture format menu.

...

6.4 Picture

3/3

The picture position on screen is not correct

- Some picture signals from some devices do not fit the screen properly. You can move the picture with the cursor keys on the remote control. Check the signal output of the device.

6.5 Sound

There is a picture but no sound

- Verify the volume is not set to 0.
- Verify the sound has not been muted with .
- Verify that all cables are connected properly.
- If no sound signal is detected, the TV automatically switches off the sound. This is proper operation and is not a malfunction.

The sound is poor

- Verify that the sound is set to Stereo.
- Select any of the Smart settings in  > Setup > Smart settings.

The sound comes from one speaker only

- Verify that the Balance is not set to extreme left or right.

Sound delay when a DVD Home Theatre System device is connected

- Read the user manual of the DVD device to adjust the audio sync delay. If you cannot set a delay, switch off HD Natural Motion in  > Setup > Picture > Perfect Pixel HD.

6.6 Devices

1/2

HDMI connections

- The HDMI-HDCP procedure might take a few seconds before the TV shows the picture from a device.
- If the TV does not recognise the device and the screen shows no picture, try switching from one device to another and back again to restart the HDCP procedure.
- If sound interruptions occur persistently, see the user manual of the device to verify the output settings. If that does not help, connect an additional audio cable.

- If a DVI to HDMI adaptor is used, verify that an additional audio connection is in place to complete the DVI connection.

HDMI with EasyLink

- Verify if the connected device supports the HDMI-CEC standard and is properly set up. Read the user manual that comes with the device.
- Verify if the HDMI cable is properly connected.
- Verify if EasyLink is activated in  > Setup > Installation > Preferences > EasyLink.

6.6 Devices

2/2

- Make sure that the System audio control in your HDMI-CEC audio devices is properly set up. Read the user manual that comes with your audio device.

EasyLink Remote control

- Some devices have identical functionality but do not support the specific remote control commands. Read Connections > EasyLink HDMI-CEC > EasyLink RC.

The PC display on my TV is not stable or is not synchronised (with TV as PC monitor)

- Set the refresh rate of your PC to 60Hz.
- Verify that the correct resolution mode is selected on your PC. Read Technical data > Display resolutions.

6.7 Multimedia

USB device content is not shown

- Set your device (camera) to 'Mass Storage Class' compliant.
- The USB device may need specific driver software. Unfortunately, this software cannot be downloaded to your TV.
- Not all audio and picture files are supported. Read Technical data.

USB device content does not play back smoothly

- The transfer performance of the USB device limits the transfer rate.

PC files are not shown in the Browse PC network menu

- Verify that files have been added in the PC folder.
- Not all file formats are supported. Read Technical data > Multimedia formats.
- You have to set the PC media server to share files with the TV. Read Setup > Network > What you need.

PC files do not play

- Read Technical data > Multimedia formats.

6.8 Network

Wireless network not found or distorted.

- Microwave ovens, Dect phones or other WiFi 11b devices in your neighbourhood might disturb the wireless network.
- Make sure that the firewalls in your network allow access to the TV wireless connection.
- If the wireless network does not work properly in your home, try the wired network installation. Read  > Setup > Installation > Network.

Net TV does not work

- If the connection to the router is OK, verify the router connection to the Internet.

Browse PC and Net TV work slow

- Look in your wireless router's user manual for information on indoor range, transfer rate and other factors of signal quality.
- You need a high speed Internet connection for your router.

7.1 Power and reception

Product specifications are subject to change without notice.

For more specification details of this product see www.philips.com/support.

Power

- Mains power : AC220-240V +/-10%
- Ambient temperature : 5°C to 35°C
- Power and standby power consumption, see the technical specification on www.philips.com

Reception

- Antenna input : 75ohm coaxial (IEC75)
- TV system : DVB COFDM 2K/8K,
- Video playback : NTSC, SECAM, PAL
- DVB : DVB-T, DVB-C, MHEG 4
(see selected countries on the TV typeplate)
- Tunerbands : VHF, UHF, S-Channel, Hyperband

7.2 Display and sound

Picture / Display

- Display type: LCD Full HD W-UXGA
- Diagonal size :
 - 42 inch / 107cm
 - 47 inch / 119cm
 - 52 inch / 132cm
- Aspect ratio : Widescreen 16:9
- Panel resolution: 1920x1080p
- Perfect Pixel HD picture enhancement
- 1080p 24/25/30/50/60Hz processing
- 200 Hz Clear LCD

Sound

- Output power (RMS) : 2 x 15 W
- Virtual Dolby Digital
- BBE

7.3 Supported display resolutions

Video formats

Resolution — Refresh rate

- 480i - 60 Hz
- 480p - 60 Hz
- 576i - 50 Hz
- 576p - 50 Hz
- 720p - 50 Hz, 60 Hz
- 1080i - 50 Hz, 60 Hz
- 1080p - 24 Hz, 25 Hz, 30 Hz
- 1080p - 50 Hz, 60 Hz

Computer formats

Resolution — Refresh rate

- 640 x 480p — 60 Hz (VGA/HDMI)
- 600 x 800p — 60 Hz (VGA/HDMI)
- 1024 x 768p — 60 Hz (VGA/HDMI)
- 1280 x 768p — 60 Hz (VGA/HDMI)
- 1360 x 765p — 60 Hz (VGA/HDMI)
- 1360 x 768p — 60 Hz (VGA/HDMI)
- 1280 x 1024p — 60 Hz (HDMI)
- 1920 x 1080i — 60 Hz (HDMI)
- 1920 x 1080p — 60 Hz (HDMI)

7.4 Multimedia

Connections

- USB
- Ethernet UTP5
- Wi-Fi 802.11g (built-in)

Supported USB / memory device formats

- FAT 16, FAT 32, NTFS

Playback formats

- MP3
- Still pictures : JPEG
- MPEG 1, MPEG 2, MPEG 4
- MPEG program stream PAL
- AVI
- H.264 (MPEG-4 AVC)
- WMA v2 up to v9.2
- WMV9

...

7.4 Multimedia

Supported media server software

- Windows Media Player 11 (for Microsoft Windows XP or Vista)
- Google (for XP)
- Twonky Media — PacketVideo 4.4.9 (for PC and Intel MacOX)
- Sony Vaio Media Server (for Microsoft Windows XP or Vista)
- TVersity v.0.9.10.3 (for Microsoft Windows XP)
- Nero 8 — Nero MediaHome (for Microsoft Windows XP)
- DiXiM (for Microsoft Windows XP)
- Macrovision Network Media Server (for Microsoft Windows XP)
- Fuppes (for Linux)
- uShare (for Linux)

- Philips NAS SPD8020 (v. 1.2.9.47)

7.5 Connectivity

Rear

- EXT1 (scart): Audio L/R, CVBS in, RGB
- EXT2 (scart): Audio L/R, CVBS in, RGB
- EXT3:Y Pb Pr, Audio L/R
- VGA, Audio L/R
- HDMI 1 in (HDMI 1.3a for all HDMI connections)
- HDMI 2 in
- HDMI 3 in
- HDMI 4 in
- Audio In L/R (DVI to HDMI)
- Audio Out L/R — display synchronised
- Digital Audio out (coaxial-cinch-S/PDIF) display synchronised
- Network — (RJ45)

- HDMI side in
- S-Video in (Y/C)
- Video in (CVBS)
- Audio L/R in (DVI to HDMI Side)
- Headphones (stereo mini jack)
- Common interface slot

Side

- USB

7.6 Dimensions and weights

42PFL9664

Width 1000mm

Height 628mm

Dept 50mm

Weight ±19kg

... with TV stand

Height 691mm

Depth 260mm

Weight ±22kg

47PFL9664

Width 1111mm

Height 694mm

Depth 50mm

Weight ±23kg

... with TV stand

Height 757mm

Depth 280mm

Weight ±26kg

UMv 3104 327 0004.5 - 091001

Safety

Risk of electric shock or fire!

- Never expose the TV or remote control to rain, water or excessive heat.
- Never place liquid containers, such as vases, near the TV. If liquids are spilt on or into the TV, disconnect the TV from the power outlet immediately. Contact Philips Consumer Care to have the TV checked before use.
- Never place the TV, remote control or batteries near naked flames or other heat sources, including direct sunlight.
- Keep candles or other flames away from this product at all times.
- Never insert objects into the ventilation slots or other openings on the TV.
- Avoid force coming onto power plugs. Loose power plugs can cause arcing or fire.
- Never place the TV or any objects on the power cord.

Risk of injury or damage to the TV!

- Two people are required to lift and carry a TV that weighs more than 55 lbs.
- If you stand mount the TV, use only the supplied stand. Secure the stand to the TV tightly. Place the TV on a flat, level surface that can support the TV's weight.
- If you wall mount the TV, use suitable fixations on a sturdy wall to safely mount the TV considering its weight. Koninklijke Philips Electronics N.V. bears no responsibility for improper wall mounting that results in accident or injury.

Risk of injury to children!

- Follow these precautions to prevent the TV from toppling over and causing injury to children.
- Never place the TV on a surface covered by a cloth or other material that can be pulled away.
 - Ensure that no part of the TV hangs over the edge of the mounting surface.
 - Never place the TV on tall furniture, such as a bookcase, without anchoring both the furniture and TV to the wall or a suitable support.
 - Educate children about the dangers of climbing on furniture to reach the TV.

Risk of overheating!

- Always leave a space of at least 4 inches around the TV for ventilation. Ensure curtains or other objects never cover the ventilation slots on the TV.

Lightning storms

Disconnect the TV from the power outlet and antenna before lightning storms. During lightning storms, never touch any part of the TV, power cord or antenna cable.

Risk of hearing damage!

Avoid using earphones or headphones at high volumes or for prolonged periods of time.

Low temperatures

If the TV is transported in temperatures below 5°C, unpack the TV and wait till TV temperature matches the room temperature to install the TV.

2009 © Koninklijke Philips Electronics N.V.

All rights reserved. Specifications are subject to change without notice. Trademarks are the property of Koninklijke Philips Electronics N.V. or their respective owners.

Philips reserves the right to change products at any time without being obliged to adjust earlier supplies accordingly. The material in the user manual is believed adequate for the intended use of the system. If the product, or its individual modules or procedures, are used for purposes other than those specified herein, confirmation of their validity and suitability must be obtained. Philips warrants that the material itself does not infringe any United States patents. No further warranty is expressed or implied.

Warranty

No components are user-serviceable. Never open or remove covers and never insert objects into the ventilation slots or insert objects not suitable for the specific connectors. Repairs may only be done by Philips Service Centres and official repairshops. Failure to do so shall void any warranty, stated or implied. Any operation expressly prohibited in this manual, any adjustments, or assembly procedures not recommended or authorised in this manual shall void the warranty.

Pixel characteristics

This LCD product has a high number of colour pixels. Although it has effective pixels of 99,999% or more, black dots or bright points of light (red, green or blue) may appear constantly on the screen. This is a structural property of the display (within common industry standards) and is not a malfunction.

Open source software

This television contains open source software. Philips hereby offers to deliver or make available, upon request, for a charge no more than the cost of physically performing source distribution, a complete machine-readable copy of the corresponding source code on a medium customarily used for software interchange. This offer is valid for a period of 3 years after the date of purchase of this product. To obtain the source code, write to Philips Innovative Applications N.V. Ass. to the Development Manager Pathoekeweg 11 B-8000 Brugge Belgium

Compliance with EMF

Koninklijke Philips Electronics N.V. manufactures and sells many products targeted at consumers, which, like any electronic apparatus, in general have the ability to emit and receive electromagnetic signals. One of Philips' leading Business Principles is to take all necessary health and safety measures for our products, to comply with all applicable legal requirements and to stay well within the EMF standards applicable at the time of producing the products. Philips is committed to develop, produce and market products that cause no adverse health effects. Philips confirms that if its products are handled properly for their intended use, they are safe to use according

Europe – EC Declaration of Conformity

to scientific evidence available today. Philips plays an active role in the development of international EMF and safety standards, enabling Philips to anticipate further developments in standardisation for early integration in its products.

Mains fuse (UK only)

This TV is fitted with an approved moulded plug. Should it become necessary to replace the mains fuse, this must be replaced with a fuse of the same value as indicated on the plug (example 10A).

1. Remove fuse cover and fuse.

2. The replacement fuse must comply with BS 1362 and have the ASTA approval mark. If the fuse is lost, contact your dealer in order to verify the correct type.

3. Refit the fuse cover.

In order to maintain conformity to the EMC directive, the mains plug on this product must not be detached from the mains cord.

Copyrights

VESA, FDMI and the VESA Mounting Compliant logo are trademarks of the Video Electronics Standards Association.

Manufactured under license from Dolby Laboratories. 'Dolby', 'Pro Logic' and the double D symbol, are trademarks of Dolby Laboratories.

Manufactured under license from BBE Sound, Inc. Licensed by BBE, Inc under one or more of the following US patents: 5510752, 5736897. BBE and BBE symbol are registered trademarks of BBE Sound Inc. Windows Media is either a registered trademark or trademark of Microsoft Corporation in the United States and/or other countries. Kensington and MicroSaver are registered US trademarks of ACCO World Corporation with issued registrations and pending applications in other countries throughout the world.

DLNA®, the DLNA logo and DNL Certified™ are trademarks, service marks, or certification marks of the Digital Living Network Alliance.

All other registered and unregistered trademarks are the property of their respective owners.

English

Hereby, Philips Innovative Applications N.V. declares that this television is in compliance with the essential requirements and other relevant provisions of Directive 1999/5/EC.

Deutsch

Hiermit erklärt Philips Innovative Applications N.V. dass sich das Fernsehgerät in Übereinstimmung mit den grundlegenden Anforderungen und den übrigen einschlägigen Bestimmungen der Richtlinie 1999/5/EG befindet.

Français

Par la présente Philips Innovative Applications N.V. déclare que cet appareil de télévision est conforme aux exigences essentielles et aux autres dispositions pertinentes de la directive 1999/5/CE.

Nederlands

Hierbij verklaart Philips Innovative Applications N.V. dat deze televisie in overeenstemming is met de essentiële eisen en de andere relevante bepalingen van richtlijn 1999/5/EG.

Español

Por medio de la presente Philips Innovative Applications N.V. declara que el televisor cumple con los requisitos esenciales y cualesquiera otras disposiciones aplicables o exigibles de la Directiva 1999/5/CE.

Italiano

Con la presente Philips Innovative Applications N.V. dichiara che questo televisore è conforme ai requisiti essenziali ed alle altre disposizioni pertinenti stabilite dalla direttiva 1999/5/CE.

Português

Philips Innovative Applications N.V. declara que este televisor está conforme com os requisitos essenciais e outras disposições da Directiva 1999/5/CE.

Ελληνικό

ΜΕ ΤΗΝ ΠΑΡΟΥΣΑ Η Philips Innovative Applications N.V. ΔΗΛΩΝΕΙ ΟΤΙ Η ΤΗΛΕΪΣΤΑΣΗ ΣΥΜΜΟΡΦΩΝΕΤΑΙ ΠΡΟΣ ΤΙΣ ΟΥΣΙΩΔΕΙΣ ΑΠΑΙΤΗΣΕΙΣ ΚΑΙ ΤΙΣ ΛΟΙΠΕΣ ΣΧΕΤΙΚΕΣ ΔΙΑΤΑΞΕΙΣ ΤΗΣ ΟΔΗΓΙΑΣ 1999/5/ΕΚ.

Svenska

Härmed intygar Philips Innovative Applications N.V. att denna TV står i överensstämmelse med de väsentliga egenskapskrav och övriga relevanta bestämmelser som framgår av direktiv 1999/5/EG.

Norsk

Philips Innovative Applications N.V. erklærer herved at utstyret TV er i samsvar med de grunnleggende krav og øvrige relevante krav i direktiv 1999/5/EF.

Dansk

Undertegnede Philips Innovative Applications N.V. erklærer herved, at dette TV overholder de væsentlige krav og øvrige relevante krav i direktiv 1999/5/EF.

Suomi

Philips Innovative Applications N.V. vakuuttaa täten että tämä televisio on direktiivin 1999/5/EY oleellisten vaatimusten ja sitä koskevien direktiivin muiden ehtojen mukainen.

Polski

Firma Philips Innovative Applications N.V. niniejszym oświadcza, że 'Telewizor' jest zgodny z zasadniczymi wymogami oraz pozostałymi stosownymi postanowieniami Dyrektywy 1999/5/EC.

Magyar

Alulírott, Philips Innovative Applications N.V. nyilatkozom, hogy a televízió megfelel a vonatkozó alapvető követelményeknek és az 1999/5/EC irányelv egyéb előírásainak.

Česky

Philips Innovative Applications N.V. tímto prohlašuje, že tento televizor je ve shodě se základními požadavky a dalšími příslušnými ustanoveními směrnice 1999/5/ES.

Slovensky

Philips Innovative Applications N.V. týmto vyhlasuje, že tento televizor spĺňa základné požiadavky a všetky príslušné ustanovenia Smernice 1999/5/ES.

Slovensko

Philips Innovative Applications N.V. izjavlja, da je ta televizor v skladu z bistvenimi zahtevami in ostalimi relevantnimi določili direktive 1999/5/ES.

Eesti

Käesolevaga kinnitab Philips Innovative Applications N.V. seadme Teler vastavust direktiivi 1999/5/EÜ põhinõuetele ja nimetatud direktiivist tulenevatele teistele asjakohastele sätetele.

Latviski

Ar šo Philips Innovative Applications N.V. deklarē, ka 'Televizors' atbilst Direktīvas 1999/5/EK būtiskajām prasībām un citiem ar to saistītajiem noteikumiem.

Lietuvių

Šiuo Philips Innovative Applications N.V. deklaruoją, kad šis 'Televizorius' atitinka esminius reikalavimus ir kitas 1999/5/EB Direktyvos nuostatas.

Malti

Hawnhekk, Philips Innovative Applications N.V., jid-dikjara li dan 'Television' jikkonforma mal-htigijiet es-senzjali u ma provvediment oħrajn relevanti li hemm fid-Dirrettiva 1999/5/EC.

Íslenska

Hér með lýsir Philips Innovative Applications N.V. yfir því að 'Television' er í samræmi við grunnkröfur og aðrar kröfur, sem gerðar eru í tilskipun 1999/5/EC.

A copy of the Declaration of Conformity is available at :
<http://www.philips.com/support>



This equipment may be operated in the following European countries ...

AT	BE	BG	CH	CY	CZ
DE	DK	EE	ES	FI	FR
GB	GR	HU	IE	IS	IT
LI	LT	LU	LV	MT	NL
NO	PL	PT	RO	SE	SK
SL	TR				

This equipment can be operated in other non-European countries.

Info for UK only.

Information about how to re-tune your TV during the digital TV switchover.



Television in the UK is going digital, bringing us all more choice and new services. Starting in late 2007 and ending in 2012, television services in the UK will go completely digital, TV region by TV region.

Please see the next page to find out when your area switches to digital.

Digital UK is the independent, non-profit organisation leading the process of digital TV switchover in the UK. Digital UK provides impartial information on what people need to do to prepare for the move to digital, and when they need to do it.

How the switchover affects your TV equipment:

Your new TV has a digital tuner built in, which means it is ready to receive the Freeview signal by simply plugging it into your aerial socket (check if you can get digital TV through your aerial now, or whether you'll have to wait until switchover, at www.digitaluk.co.uk).

When the TV switchover happens in your area, there are at least two occasions when you will need to re-tune your TV in order to continue receiving your existing TV channels, and also to pick up new ones.

get set for digital

Digital UK, the body leading the digital TV switchover, will advise you when you need to re-tune during the switchover. If you choose to connect your TV to satellite or cable with a digital box then it will not be affected by switchover, and you won't need to re-tune.

If you have any questions, please contact your equipment supplier or call Digital UK on ... 0845 6 50 50 50 or visit www.digitaluk.co.uk

How to re-tune:

To find out how to re-tune your TV, check this user manual for details. Go to section **6 Install channels**.

If you do not re-tune your channels when advised to do so by Digital UK, you may lose some or all of your channels until you do re-tune. You should re-tune your TV every few months to check for any new channels.

If you are missing any channels, it may be that they are not available in your area, or that your aerial needs upgrading.

When does switchover happen?

*Copeland switches on October 17, 2007

The exact date you switch depends on the transmitter you are served by. To check when you switch, go to Digital UK's postcode checker on www.digitaluk.co.uk

Check your ITV news service or look at Teletext page 106 to see what TV region you're in.

Visit us at digitaluk.co.uk
Call us on 0845 6 50 50 50†

† Calls charged at BT rate of 3p per minute daytime and 1p per minute evenings and weekends. Rates may vary for calls from non-BT lines.

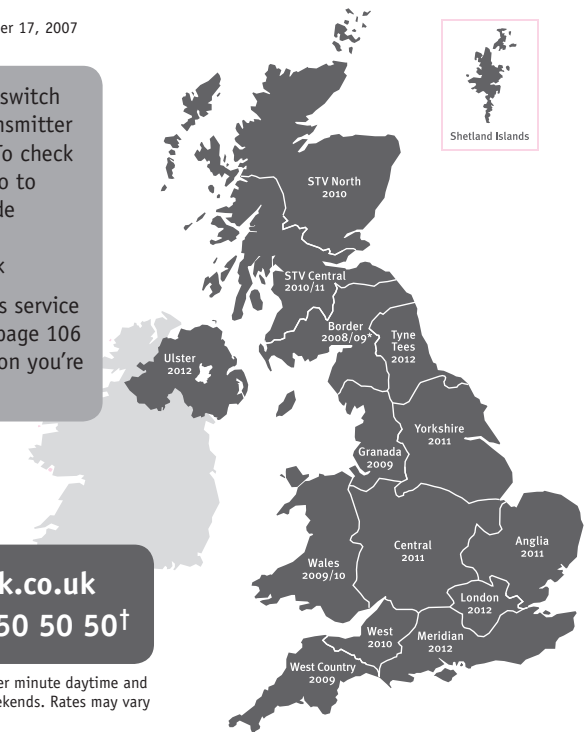

PHILIPS

ГАРАНТИЙНЫЙ ТАЛОН НА ТЕЛЕВИЗОР

Модель:

Серийный номер:

Дата продажи:

ПРОДАВЕЦ:

Название торговой организации:

Телефон торговой организации:

Адрес и E-mail:



ПЕЧАТЬ
ПРОДАВЦА

**Изделие получен в исправном состоянии.
С условиями гарантии ознакомлен и согласен.**

(подпись покупателя)

Внимание! Гарантийный талон недействителен без печати продавца.

Уважаемый потребитель!

Компания **Филипс** выражает благодарность за Ваш выбор и гарантирует высокое качество и безупречное функционирование Вашего телевизора при соблюдении правил его эксплуатации.

При покупке убедительно просим проверить правильность заполнения гарантийного талона. Серийный номер и наименование модели приобретенного Вами телевизора должны быть идентичны записи в гарантийном талоне. Не допускается внесения в талон каких-либо изменений, исправлений. В случае неправильного или неполного заполнения гарантийного талона немедленно обратитесь к продавцу.

Телевизор представляет собой технически сложный товар. При бережном и внимательном отношении он будет надежно служить Вам долгие годы. В ходе эксплуатации не допускайте механических повреждений, попадания вовнутрь посторонних предметов, жидкостей, насекомых, в течение всего срока службы следите за сохранностью идентификационной наклейки с обозначением наименования модели и серийного номера изделия.

Если в процессе эксплуатации изделия Вы сочтете, что параметры работы телевизора отличаются от изложенных в инструкции пользователя, рекомендуем обратиться за консультацией в наш Информационный центр.

Условия гарантии

Объект	Телевизор	Пульт дистанционного управления
Срок гарантии	1 год	1 год
Срок службы	5 лет	1 год

Срок гарантии и срок службы исчисляется со дня передачи товара потребителю.

По окончании срока службы обратитесь в авторизованный сервисный центр для проведения профилактических работ и получения рекомендаций по дальнейшей эксплуатации изделия.

Во избежание возможных недоразумений, сохраняйте в течение срока службы документы, прилагаемые к товару при его продаже (данный гарантийный талон, товарный и кассовый чеки, накладные, данную инструкцию по эксплуатации и иные документы).

Гарантийное обслуживание не распространяется на изделия, недостатки которых возникли вследствие:

1. Нарушения потребителем правил эксплуатации, хранения или транспортировки товара
2. Действий третьих лиц:
 - ремонта неуполномоченными лицами;
 - внесения несанкционированных изготовителем конструктивных или схематических изменений и изменений программного обеспечения
 - отклонение от Государственных Технических Стандартов (ГОСТов) и норм питающих, телекоммуникационных и кабельных сетей;
 - неправильной установки и подключения изделия;
3. Действия непреодолимой силы (стихия, пожар, молния и т.п.);

Любую информацию о расположении сервисных центров и о сервисном обслуживании Вы можете получить в Информационном Центре

Телефон: (495) 961-1111, 8 800 200-0880 (бесплатный звонок по России).
Интернет: www.philips.ru

Diagramma elettronico / Electronic diagram

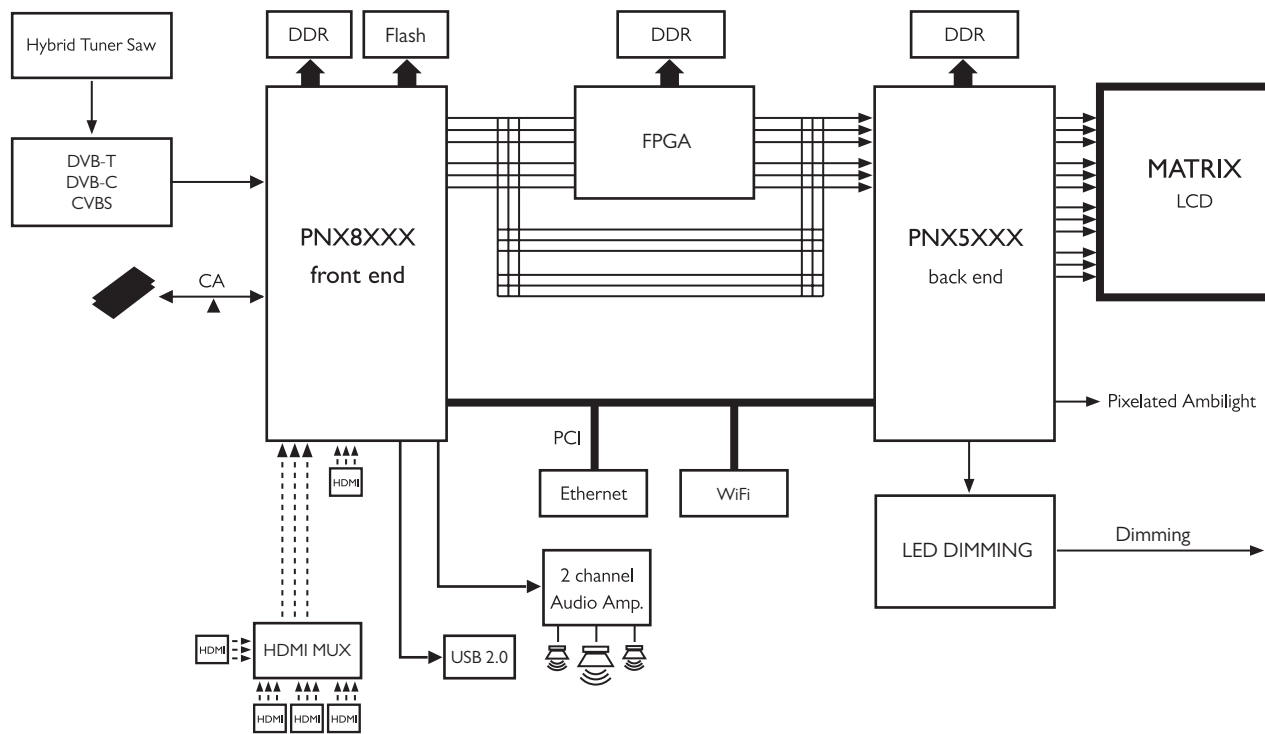

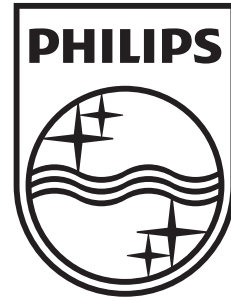

www.philips.com/tv

Non-contractual images. / Images non contractuelles. / Außervertragliche Bilder.

All registered and unregistered trademarks are property of their respective owners.

Specifications are subject to change without notice

Trademarks are the property of Koninklijke Philips Electronics N.V. or their respective owners

2009 © Koninklijke Philips Electronics N.V. All rights reserved

www.philips.com