

Register your product and get support at
www.philips.com/welcome

User Manual

32PHS4012
42PFS4012
43PFS4012
50PFS4012

PHILIPS

Contents

Safety and Screen care	4	Remote Control	10
Safety	4	1.Key overview	10
Risk of electric shock or fire!	4	Top view	10
Risk of short circuit or fire!	4	Middle view	10
Risk of injury or damage to the TV!	4	Bottom view	10
Risk of injury to children!	4	2.Key overview	11
Risk of swallowing batteries!	4	Top view	11
Risk of overheating!	4	Middle view	11
Risk of injury, fire or power cord damage!	4	Bottom view	11
Risk of hearing damage!	4	IR sensor	12
Low temperatures	4	Batteries	12
Screen care	4	Cleaning	12
INITIAL SETUP	5	TV channels	12
Read safety	5	Channel list	12
TV stand installation and wall mounting instructions	5	About Channel list	12
TV stand installation	5	Open a channel list	12
Wall mounting instructions	5	Filter a channel list	12
Tips on placement	5	Watching TV channels	12
Power cable	5	Tune to a channel	12
Antenna cable	5	About move Channels	12
Satellite dish	5	Lock a channel	12
		Favourite Channels	12
		Open channel menu	12
Connecting Your Devices	6	Channel	13
About connection	6	Channel installation-Antenna, Cable	13
Connectivity guide	6	Update channels	13
Antenna port	6	Channel installation-Satellite	13
HDMI ports	6	Watching Satellite Channel	13
Y Pb Pr - Audio L R	7	Satellite Channel installation	13
CVBS-Audio L R	7	Channel Edit	13
Audio Out- Optical (SPDIF-OUT)	7	Schedule List	13
Common interface-CAM	7	Signal information	13
CI+	7	Software Update (OAD)	13
CAM	7	CI information	13
Set-top box-STB	7	Dish Setup	13
Satellite receiver	7	Manual Installation	13
Home Theatre System	8	Add a satellite	13
Connect with HDMI ARC	8	Transponder Setup	14
Connect with HDMI	8	Ku_HOTBIRD Setup	14
Blue-ray Disc player	8		
DVD player	8	TV Program Guide	14
Game console	8	What you need	14
USB flash drive	8	Using the TV Program guide	14
Computer	8	Open the TV guide	14
Headphone	8	Record	14
USB interface	8	Remind	14
		Prev Day	14
Switch on		Next Day	14
Power on/off, standby	8		
Power on	8		
Standby	8		
Power off	8		
Keys on TV	9		
	9		

Recording and Time-shift	15	MULTIMEDIA	17
Recording	15	From a USB connection	17
What you need	15	Photo	17
Record a programme	15	Music	18
Open the list of recording	15	Movie	18
Time-shift	15	TEXT	18
What you need	15		
Use Time-shift for a programme	15	Specification information	19
Replay	15	Display resolutions	19
		Multimedia	19
Sources	15	Sound power	19
Switch a device signal	15	Display resolution	19
From standby	15	Tuner/Reception/Transmission	19
EasyLink	15	Remote Control	19
		Power Supply	19
Time	16	Dimensions and weights	19
Time settings	16		
Sleep timer	16	Software	20
Time Zone	16	Software update	20
Auto Standby	16	Open source software	20
OSD Timer	16	Open source license statement	20
Summer Time	16		
LOCK	16	Troubleshooting and support	20
System Lock	16	General issues	20
Set Password	16	Channel issues	20
Channel Lock	16	Picture issues	20
Parental Guidance	16	Sound issues	21
Key Lock	16	HDMI connection issues	21
		Computer connection issues	21
SETTING	16	Contact us	21
General Settings	16	Warning	21
Language	16		
TTX Language	16	Term of use, copyrights and licenses	21
Audio Language	16	Term of use	21
Subtitle Language	16	Copyrights and Licenses	21
Hearing impaired	16		
PVR file system	16		
Aspect ratio	16		
Blue screen	16		
First time installation	16		
Reset	16		
Software Update (USB)	16		
HDMI CEC-Easylink	16		
Help	16		
Picture	17		
Picture Setting	17		
Sound	17		
Sound Setting	17		

Safety and Screen care

Safety

Risk of electric shock or fire!

- Never expose the TV to rain or water.
- Never place liquid containers, such as vases, near the TV. If liquid was spilled on or into the TV, disconnect the TV from the power outlet immediately. Contact Philips Consumer Care to have the TV checked before use.
- Never place the TV, remote control or batteries near naked flames or other heat sources, including direct sunlight.
- To prevent the spread of fire, keep candles or other flames away from the TV, remote control and batteries at all times.
- Never insert objects into the ventilation slots or other openings on the TV.
- When the TV is swivelled ensure that no strain is exerted on the power cord. Strain on the power cord can loosen connections and cause arcing.
- To disconnect the TV from the mains power, the power plug of the TV must be disconnected. When disconnecting the power, always pull the power plug, never the cord. Ensure that you have full access to the power plug, power cord and outlet socket at all times.

Risk of short circuit or fire!

- Never expose the remote control or batteries to rain, water or excessive heat.
- Avoid force coming onto power plugs. Loose power plugs can cause arcing or fire.

Risk of injury or damage to the TV!

- Two people are required to lift and carry a TV that weighs more than 25 kg or 55 lbs.
- When stand mounting the TV, use only the supplied stand. Secure the stand to the TV tightly. Place the TV on a flat, level surface that can support the combined weight of the TV and the stand.
- When you wall mounting the TV, use only a wall mount that can support the weight of the TV. Secure the wall mount to a wall that can support the combined weight of the TV and wall mount. TPVision Europe B.V. bears no responsibility for improper wall mounting that result in accident, injury or damage.
- If you need to store the TV, disassemble the stand from the TV. Never lay the TV on its back with the stand installed.
- Before you connect the TV to the power outlet, ensure that the power voltage matches the value printed on the back of the TV. Never connect the TV to the power outlet if the voltage is different.
- Parts of this product may be made of glass. Handle with care to avoid injury and damage.

Risk of injury to children!

- Follow these precautions to prevent the TV from toppling over and causing injury to children:
- Never place the TV on a surface covered by a cloth or other material that can be pulled away.
- Ensure that no part of the TV hangs over the edge of the surface.
- Never place the TV on tall furniture (such as a bookcase) without anchoring both the furniture and TV to the wall or a suitable support.
- Educate children about the dangers of climbing on furniture to reach the TV.

Risk of swallowing batteries!

- The product/remote control may contain a coin-type battery, which can be swallowed. Keep the battery out of reach of children at all times!

Risk of overheating!

- Never install the TV in a confined space. Always leave a space of at least 4 inches or 10 cm around the TV for ventilation. Ensure curtains or other objects never cover the ventilation slots on the TV.

Risk of injury, fire or power cord damage!

- Never place the TV or any objects on the power cord.
- Disconnect the TV from the power outlet and antenna before lightning storms. During lightning storms, never touch any part of the TV, power cord or antenna cable.

Risk of hearing damage!

- Avoid using earphones or headphones at high volumes or for prolonged periods of time.

Low temperatures

- If the TV is transported in temperatures below 5oC or 41oF, unpack the TV and wait until the TV temperature matches room temperature before connecting the TV to the power outlet.

Screen care

- Avoid stationary images as much as possible. Stationary images are images that remain on-screen for extended periods of time. Example: on-screen menus, black bars and time displays. If you must use stationary images, reduce screen contrast and brightness to avoid screen damage.
- Unplug the TV before cleaning.
- Clean the TV and frame with a soft, damp cloth. Never use substances such as alcohol, chemicals or household cleaners on the TV.
- Risk of damage to the TV screen! Never touch, push, rub or strike the screen with any object.
- To avoid deformations and color fading, wipe off water drops as soon as possible.
- Note: Stationary images may result in permanent damage to the TV screen.
- Do not display stationary images on the LCD screen for more than two hours as this may result in ghost images. To prevent this, reduce screen brightness and contrast.
- Viewing programs in the 4:3 formats for extended periods of time may leave different traces on the left and right edges of the screen as well as along the borders of the image. Avoid using this mode for extended periods of time.
- Displaying stationary images from video games or computers for an extended period of time may result in partial after-images and the appearance of ghost images caused by screen burn. Reduce screen brightness and contrast accordingly when using the TV in this way.
- Ghost images, partial after-images, and other traces that appear on the TV screen as a result of the above are not covered by the warranty.

INITIAL SETUP

Read safety

Please read the safety instructions first before you use the TV. In Help, go to **Safety and Screen care**.

TV stand installation and wall mounting instructions

TV stand installation

You can find the instructions on how to install the TV stand in the Quick Start Guide that come together in the carton box when you unpack the TV. In case you have misplaced your Quick Start Guide, you can download it from www.philips.com. Use the product type number of the TV to look for the Quick Start Guide to download.

Wall mounting instructions

Your TV is also prepared for a VESA –compliant wall mount bracket (sold separately).

Use The following VESA code when purchasing the wall mount.

To fix the bracket securely, use screws with a length indicated in the drawing.

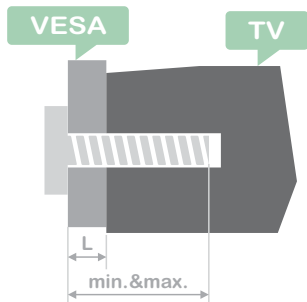

Tips: This picture is only for reference.

Take note of the following, the "L" is stand for the thickness of VESA.

32PHS4001 / 32PHT4001:

VESA MIS-F 200x100mm, M4x25mm.

42PFS4012 / 43PFS4001 / 43PFT4001 / 49PFS4001 /

49PFT4001:

VESA MIS-F 200x300mm.

Top side M6x43mm.

Bottom side M6x28mm.

32PHS4012:

VESA MIS-F 100x100mm, M4x23mm.

43PFS4012:

VESA MIS-F 400x200mm.

Top side M6x45mm.

Bottom side M6x23mm.

50PFS4012/12:

VESA MIS-F 200x200mm.

Top side M6x45mm.

Bottom side M6x23mm.

Caution:

Wall mounting the TV requires special skills and should only be performed by qualified personnel. The TV wall Mounting should meet safety standards according to TV's weight. Also read the safety precautions before positioning the TV.

TP Vision Europe B.V. bears no responsibility for improper actions. TV mounting that results in accident, injury or damage.

Tips on placement

- Position the TV where light does not shine directly on the screen.
- Position the TV up to 15cm away from the wall.
- The ideal distance to watch TV is 3 times its diagonal screen size. When seated your eyes should be level with centre of screen.

Power cable

- Insert the power plug into the outlet complete.
- Make sure that power plug in the wall socket is accessible at all time.
- Tips: If you do not use the TV for a long period of time, please unplug the power cord.

Antenna cable

- Insert the antenna plug firmly into the ANTENNA socket at the back of the TV.
- You can connect your own antenna signal from an antenna distribution system. Use an IEC Coax 75 Ohm RF antenna connector. Use this antenna connection for DVB-T and DVB-C input signals.

Satellite dish

For PHS and PFS models.

Attach the satellite F-type connector to the satellite connection SAT at the back of TV.

Connecting Your Devices

About connection Connectivity guide

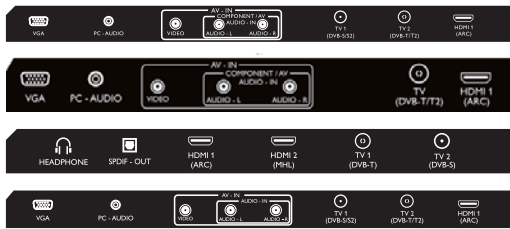
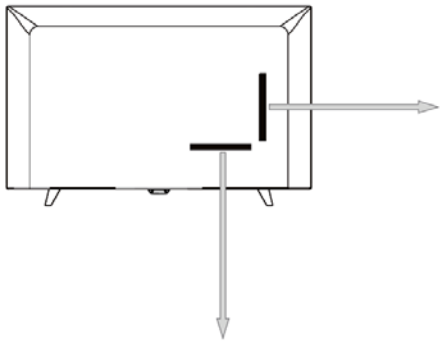

Always connect a device to the TV with the highest quality connection Available. Also use good quality cables to ensure a good transfer of picture and sound. If you need help to connect several devices to the TV, you can visit the Philips TV connectivity guide. The guide offers information on how to connect and which cables to use. Go to www.connectivityguide.philips.com.

Antenna port

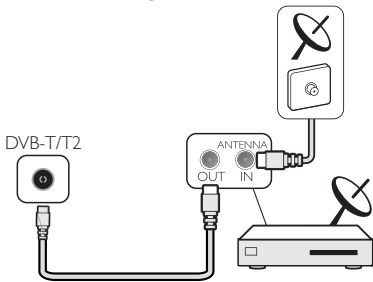

If you have a Set-top box (a digital receiver) or Recorder, connect the antenna cables to run the antenna signal through the Set-top box or Recorder first before it enters the TV. In this way, the antenna and Set-top box can send possible additional channels to the Recorder to record.

HDMI ports

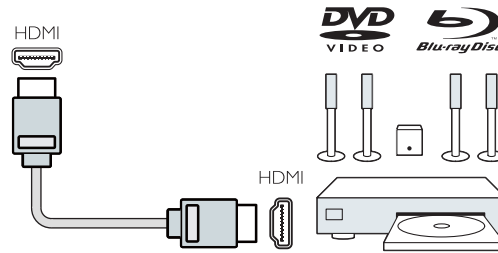

HDMI Quality

An HDMI connection has the best picture and sound quality. Use an HDMI cable for TV signal. For best signal quality transfer, use a High speed HDMI cable and do not use an HDMI cable longer than 5 m.

HDMI MHL

HDMI 3 connection on the TV have HDMI MHL (Mobile High-Definition Link).

Note: 32PHS4012: HDMI 2 connection on the TV have HDMI MHL (Mobile High-Definition Link).

HDMI CEC-Easylink

Easylink: With Easylink you can operate a connected device with the TV remote control, EasyLink uses HDMI CEC (Consumer Electronics Control) to communicate with the connected devices. Devices must support HDMI CEC and must be connected with an HDMI connection.

EasyLink setup: The TV comes with Easylink switched on. Make sure that all HDMI CEC settings are properly set up on the connected EasyLink devices. EasyLink might not work with devices from other brands.

HDMI CEC on other brands: The HDMI CEC functionality has different names on different brands. Some examples are: Anynet, Aquos Link, Bravia Theatre Sync, Kuro Link, Simplink and Viera Link. Not all brands are fully compatible with EasyLink.

Example HDMI CEC branding names are property of their respective owners.

Operate devices: You can operate a device connected to HDMI and set up with HDMI CEC of TV connections. Press **MENU** key to enter the main menu and select **SETTING**, press **OK** key enter the setting menu, on the screen press **▲/▼** key to select **HDMI CEC**. Press **OK** key to enter submenu, select **CEC control** to turn on and you can adjust these options.

Easy-Link On or Off: Enter the setting menu, on the screen press **▲/▼** key to select **HDMI CEC**. Press **OK** key to enter submenu, select **CEC control** to turn on or off.

Easy-Link Remote Control: If you want devices to communicate but you don't want to operate them with the TV remote control, you can switch off Easy-Link remote control separately.

You can control multiple HDMI-CEC compliant devices with your TV remote control.

In the settings menu, select **EasyLink Remote control** and select off.

DVI to HDMI

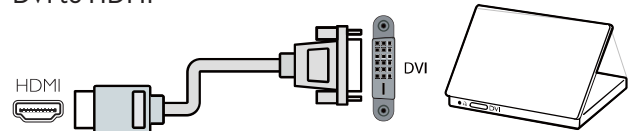

If you still own a device that only has a DVI connection, you can connect the device to any of the HDMI connection with a DVI to HDMI adapter.

Use a DVI to HDMI adapter if your device only a DVI connection. Use one of the HDMI connection and add an Audio L/R cable to Audio in for sound, on the back of the TV.

Copy protection

DVI and HDMI cables support HDCP (High-bandwidth Digital Content Protection). HDCP is a copy protection signal that prevents copying content from a DVD disc or Blu-ray Disc. Also referred to as DRM (Digital Rights Management).

Y Pb Pr - Audio L R

CVBS-Composite video is a high quality connection. Next to the CVBS signal is the Audio left and right for sound.

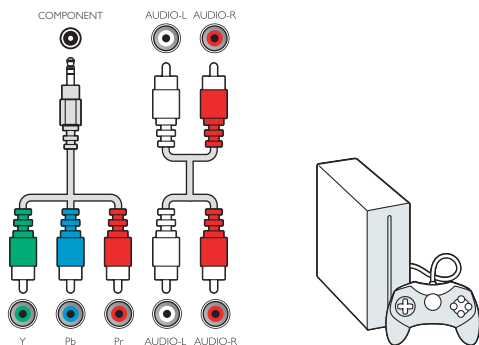

Y Pb Pr

Component video is a high quality connection. The YPbPr connection can be used for High definition (HD) TV signals.

Mini-YPbPr

Please use mini-YPbPr wire to make connection. Match the YPbPr (green, blue, red) connector colours with the cable plugs when you connect.

Use an Audio L/R cinch cable if your device also has sound.

CVBS-Audio L R

CVBS-Composite video is a high quality connection. Next to the CVBS signal is the Audio left and right for sound.

Audio Out- Optical (SPDIF-OUT)

Audio-Out-Optical is a high quality sound connection. This optical connection can carry 5.1 audio channels. If your device, typically a Home Theatre (HTS), has no HDMI ARC connection, you can use this connection with the Audio In-Optical connection on the HTS. The Audio-Out-Optical connection sends the sound from the TV to the HTS.

You can Press **MENU** key to enter the main menu and select **SOUND**, press **OK** key enter the submenu, then on the screen press **▲/▼** key to select SPDIF Mode, press **◀/▶** key to adjust the options, like PCM, Auto, off.

Common interface-CAM

CI+

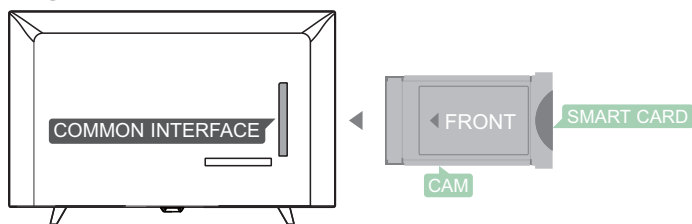

This TV is ready for the CI conditional Access.

With CI+ you can watch premium HD programs, like movies and sports live offered by digital TV broadcasters in your region. These programs are scrambled by the TV broadcaster and descrambled with a prepaid CI+ module.

Contact a digital TV broadcaster for more information on terms and conditions.

CAM

Insert a CAM module.

Switch off the TV before inserting a CAM.

Use the CAM for the correct method of insertion. Incorrect insertion can damage the CAM and TV.

Use the CI Interface slot on the TV to insert the CAM card.

With the front of the card facing to you, gently insert the CAM as far as it will go.

Leave the card in the slot permanently.

It may take a few minutes before the CAM is activated.

Removing the CAM will deactivate the broadcast service on the TV.

If a CAM is inserted and subscription fees are paid, (connection method can differ), you can watch the TV broadcast. The inserted CAM is exclusively for your TV.

Set-top box-STB

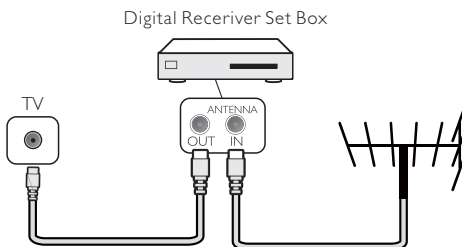

Use 2 antenna to connect the antenna to the Set-top box (a digital receiver) and the TV.

Next to the antenna connections, add an HDMI cable to connect the Set-top box to the TV.

Auto Standby

If you only use the remote control of the Set-top box. Do this to prevent the TV from auto standby after a 5 hour period without a key on the remote control of the TV.

To set Auto Standby, press **MENU** key and select **TIME** and press **OK** key.

TIME > Auto Standby and set the slider bar to off.

Satellite receiver

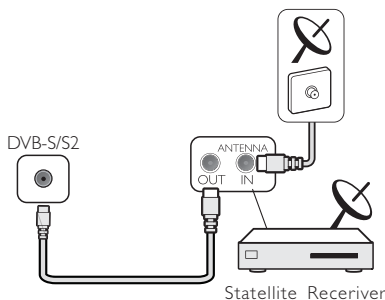

Connect the dish antenna cable to the satellite receiver.

Next to the antenna connections, add an HDMI cable to connect the Set-top box to the TV.

Auto Standby

If you only use the remote control of the Set-top box. Do this to prevent the TV from auto standby after a 5 hour period without a key on the remote control of the TV.

To set Auto Standby, press **MENU** key and select **TIME** and press **OK** key.

TIME > Auto Standby and set the slider bar to off.

Home Theatre System

Connect with HDMI ARC

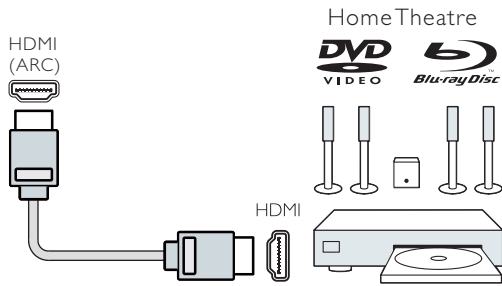

Use an HDMI cable to connect a Home Theatre System (HTS) to the TV. You can connect a Philips Soundbar or an HTS with a built-in disc player.

HDMI ARC

HDMI 1 connection on the TV have HDMI ARC (Audio Return Channel). If the device, typically a Home Theatre System (HTS), also has the HDMI ARC connection, connect it to HDMI 1 on this TV. With the HDMI ARC connection, you do not need to connect the extra audio cable that sends the sound of the TV picture to the HTS. The HDMI ARC connection combines both signals.

Audio to video synchronisation (sync)

If the sound does not match the video on screen, you can set a delay on most Home Theatre System with a disc player to match the sound with video.

Connect with HDMI

Use an HDMI cable to connect a Home Theatre System (HTS) to the TV. You can connect a Philips Soundbar or an HTS with a built-in disc player.

If the Home Theatre System has no HDMI ARC connection, add an optical audio cable (Toslink) to send the sound of the TV picture to the Home Theatre System.

Audio to video synchronisation (sync)

If the sound does not match the video on screen, you can set a delay on most Home Theatre System with a disc player to match the sound with video.

Blue-ray Disc player

Use a High speed HDMI cable to connect the Blue-ray Disc player to the TV.

If the Blue-ray Disc player has EasyLink HDMI CEC, you can operate the player with the TV remote control.

DVD player

Use an HDMI cable to connect the DVD player to the TV.

If the DVD player has EasyLink HDMI CEC, you can operate the player with the TV remote control.

Game console

HDMI: For best quality, connect the game console with an High speed HDMI cable to the TV.

Y Pb Pr- Audio L R: Connect the game console with a component video cable (Y Pb Pr) and add an audio L/R cable for sound to the TV.

CVBS- Audio L R: Connect the game console to TV with a composite cable (CVBS) and audio L/R cable to the TV.

USB flash drive

You can view photos or play your music and videos from a connect USB flash drive.

Insert a USB flash drive in one of the USB connections on the

TV while the TV is switch on.

The TV detects the flash drive and show a window with a tips to whether you can browse the USB flash drive.

If the tips is disappeared, you can press **SOURCE** key, select MULTIMEDIA and press **OK** key to enter.

Computer

You can connect your computer to the TV and use the TV as a PC monitor.

With HDMI

Use an HDMI cable to connect the computer to the TV.

With DVI to HDMI

Alternatively, you can use a DVI to HDMI adapter to connect the PC to HDMI and an audio L/R cable (mini-jack 3.5mm) to AUDIO IN L/R on the back of the TV.

With VGA

Connect the PC IN jack (HD15-HD15) to VGA Port, on the back of the TV. Then connect the audio cable to PC-AUDIO for sound.

Headphone

You can connect a set of headphone to HEADPHONE Port on the back of the TV. Press +/- key on the remote control to adjust the volume.

USB interface

Insert USB storage device into USB interface of the TV. Press **SOURCE** key to enter the signal input menu, then press **▲/▼** key to select MULTIMEDIA. Press **OK** key to enter the USB multimedia.

Note:

1. USB function support file format as, PHOTO/MUSIC/MOVIE/TEXT, the USB device format can only be FAT/FAT32 system.
2. When connecting the USB port on an external device current is exceed 500mA, It will be caused damage of the TV.
3. When the USB device is working, do not pull out immediately, It will be caused damage of the TV system or the USB device system.

Switch on

Power on/off, standby

Power on

Before you switch on the TV, make sure the power supply is stable. When the TV is powered on, the power indicator is lights up. If the TV have power switch "ⓐ", you can press "I" end to turn power on, and press "O" end to turn power off.

When the power indicator is lights up, press "ⓐ" key on the remote control or on the panel control of the TV, and then the TV system will be running up.

Standby

When the TV system is running, press "ⓐ" key, and then the TV will be switch to standby status.

Power off

To switch the TV off completely, press the hard Switch or unplug the power cord, and then the power indicator will be extinguished. If you do not use the TV for a long time, please unplug the power cord.

Keys on TV

If you lost the remote control or its batteries are empty, you can still do some basic TV operations.

View the control buttons as below:

32PHS4001/32PHT4001/42PFS4012

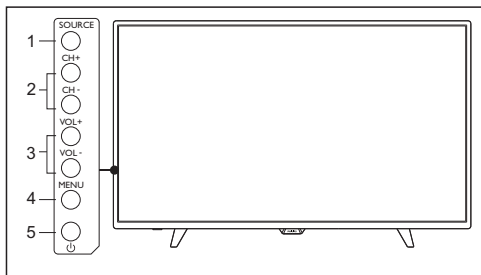

43PFS4001/43PFT4001/49PFS4001/49PFT4001

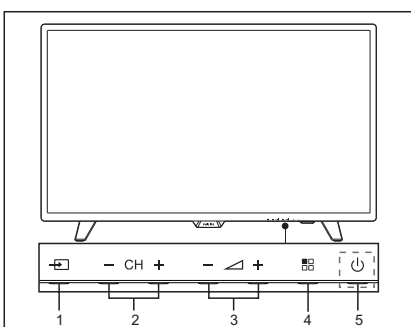

1. SOURCE (➡): Display the signal source list.
2. CH-/CH+ (- CH +): Switch the previous/next channel.
3. VOL-/VOL+ (- ▲ +): reduce/increase the volume.
4. MENU (☰): turn on/off the main menu.
5. ⏻: Turn on/off the TV, to cut off power supply, please unplug the power cable.

32PHS4012

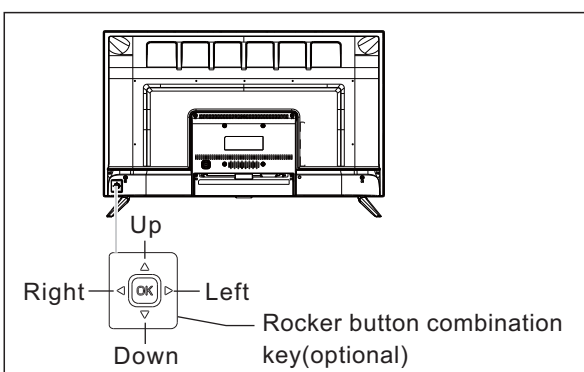

Rocker button combination key(optional):

Press OK Rocker:

- ①. After turn on the TV, In non-OSD menu operation, press OK rocker to display the menu which includes 4 sorts: Menu, Source, Power, Exit. During the menu operation, press OK rocker to confirm the operation, the function is the same with pressing [OK] key on the remote control.
- ②. Under the non USB source menu, long press OK rocker 2 seconds to return to previous page.

- ③. Under the USB source menu, long press OK rocker 2 seconds to display the "Input Source" menu on the screen.

Move rocker **Left/Right**:

- ①. In non-OSD menu operation, move rocker **Left/Right** to decrease/increase the volume, the function is the same with pressing [VOL+]/[VOL-] key on the remote control.
- ②. In OSD menu operation, move rocker **Left/Right** to adjust the analog value of selected item, the function is the same with pressing [◀]/[▶] key on the remote control.

Move rocker **Up/Down**:

- ①. In non-OSD menu operation, move rocker **Up/Down** to select the channel, the function is the same with pressing [CH+]/[CH-] key on the remote control.
- ②. In OSD menu operation, move rocker Up/Down to select the adjustment items, the function is the same with pressing [▲]/[▼] key on the remote control.

50PFS4012

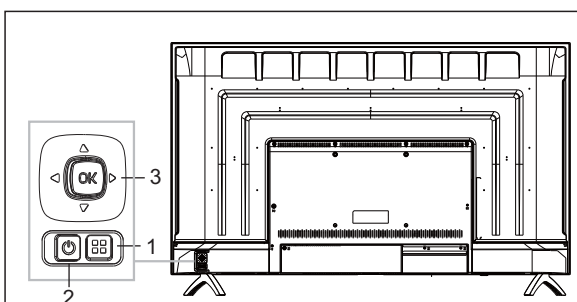

- 1) ☰ Menu key: Press this key to display the setup menu. In OSD menu operation, press this key to return to the previous menu.
- 2) ⏻ Standby: To switch the TV on or back to standby.
- 3) Rocker button combination key:

OK Rocker: Press rocker to enter the source select menu; in OSD menu operation, press rocker to confirm operation, with the same function as the [OK] key on the remote control.

Move rocker Up/Down: The channel number increase/ decrease; in OSD menu operation, moving rocker up/ down to select the adjustment items, with the same function as the [▲]/[▼] key on the remote control.

Move rocker Left/Right: volume decrease/increase key; in OSD menu operation, move rocker left/right to adjust the analog value, with the same function as the [◀]/[▶] key on the remote control.

Remote Control

1. Key overview (4001 series)

Top view

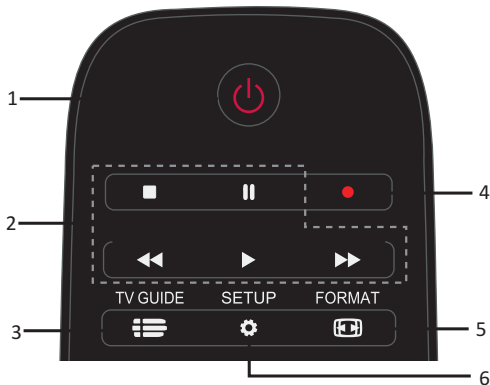

1. Standby/ on:
 - To switch the TV on or back to Standby.
2. Play back keys
 - Shortcut keys in USB mode: STOP, PAUSE, REWIND, START, FAST FORWARD.
3. TV GUIDE
 - An Instant access to TV program guide.
 - Availability of electronic program guide (EPG) is dependent on broadcasters or operators.
4. Recording
 - To record TV program, press (Record) on the remote control.
 - To schedule a recording of an upcoming TV program, press **TV GUIDE** then select the TV program you wish to record. Press **(Record)** on remote control to set the recording schedule.
5. FORMAT
 - Display the image aspect ratio.
6. SETUP
 - Display the setting options on the TV screen you can adjust these items by yourself.

Middle view

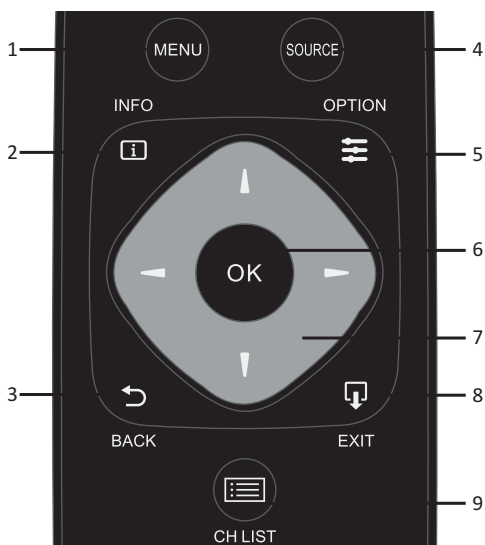

1. MENU
 - Turn on/off the menu.
2. INFO
 - Display the program information when it is available.
3. BACK
 - Return to the previous channel.
4. SOURCE
 - To open or close the Source menu- the list of connected devices.
5. OPTION
 - Select an item of option settings for the TV.
6. OK
 - In menu mode: confirm the input or selection.
7. Arrow/ navigation keys, to navigate up, down, left or right.
8. EXIT
 - Press this key to exit menu.
9. CH LIST
 - Look through channel list.

Bottom view

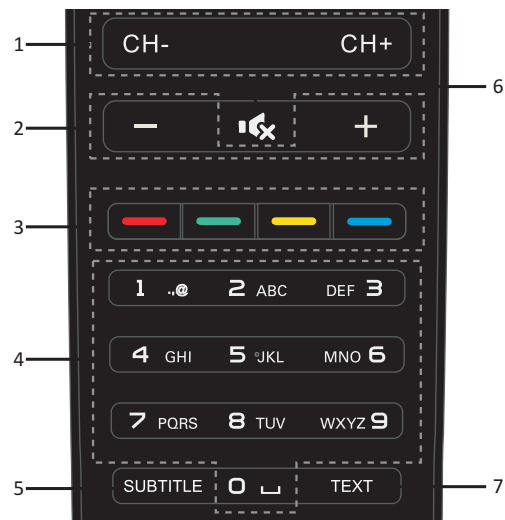

1. CH-/CH+
 - To switch to the previous/next channel in the channel list. To open the previous/next page in Text/Teletext.
2. +/- Volume
 - To adjust the volume level
3. Color key
 - The button's function follow the on-screen instructions.
4. Numeric keys (0~9)
 - Select a channel or value.
5. SUBTITLE
 - Display the subtitle message when current channel has subtitle option.
6. Mute
 - To mute the sound or to restore it.
7. TEXT
 - To open or close Text/Teletext.

2. Key overview (4012 series)

Top view

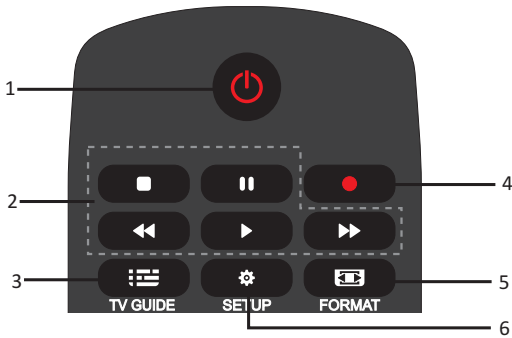

1. Standby/ on:
 - To switch the TV on or back to Standby.
2. Play back keys
 - Shortcut keys in USB mode: STOP, PAUSE, REWIND, START, FAST FORWARD.
3. TV GUIDE
 - An Instant access to TV program guide.
 - Availability of electronic program guide (EPG) is dependent on broadcasters or operators.
4. Recording
 - To record TV program, press (Record) on the remote control.
 - To schedule a recording of an upcoming TV program, press TV GUIDE then select the TV program you wish to record. Press (Record) on remote control to set the recording schedule.
5. FORMAT
 - Display the image aspect ratio.
6. SETUP
 - Display the setting options on the TV screen you can adjust these items by yourself.

Middle view

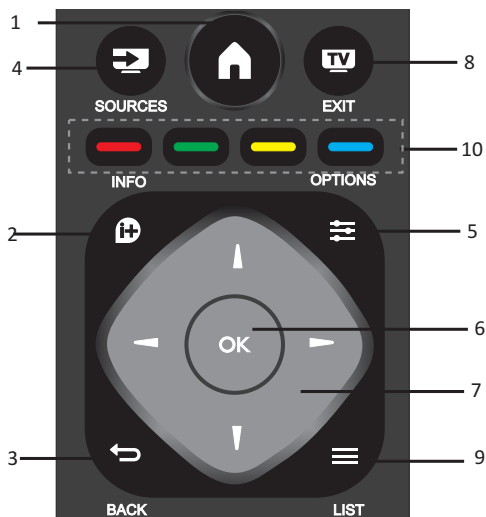

1.
 - Turn on/off the menu.
2. INFO
 - Display the program information when it is available.
3. BACK
 - Return to the previous channel.
4. SOURCES
 - To open or close the Source menu- the list of connected devices.
5. OPTIONS
 - Select an item of option settings for the TV.
6. OK
 - In menu mode: confirm the input or selection.
7. Arrow/ navigation keys, to navigate up, down, left or right.
8. EXIT
 - Press this key to exit menu and DTV.
9. LIST
 - Look through channel list.
10. Color key
 - The button's function follow the on-screen instructions.

Bottom view

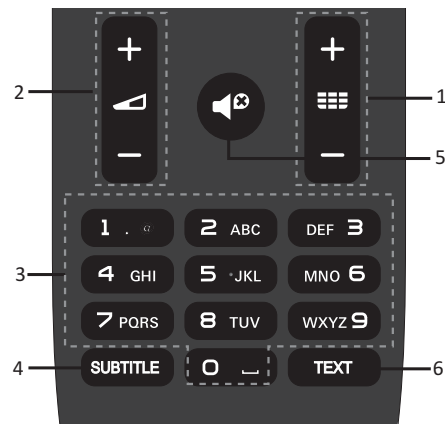

1. +/-
 - To power on and switch to the previous/next channel in the channel list. To open the previous/next page in Text/Teletext.
2. +/-
 - To adjust the volume level
3. Numeric keys (0~9)
 - Select a channel or value.
4. SUBTITLE
 - Display the subtitle message when current channel has subtitle option.
5.
 - To mute the sound or to restore it.
6. TEXT
 - To open or close Text/Teletext.

IR sensor

The TV can receive commands from a remote control that uses IR (infrared) to send commands. If you use such a remote control, hold it close to the TV and make sure you point the remote control at the infrared sensor on the front of the TV.

Make sure that the line-of-sight between the remote control and TV is not blocked by furniture, walls or other objects.

Batteries

1. Slide the battery door in the direction shown by the arrow.
2. Insert two type AAA-LR03-1.5V batteries into remote control, make sure the + and the – ends of the batteries line up correctly.
3. Reposition the battery door.

Cleaning

Your Remote control is treated with a scratch-resistant coating.

To clean the remote control, use a soft damp cloth. Never use substances such as alcohol, chemicals or household cleaners on the remote control.

TV channels

Channel list

About Channel list

After a channel installation, all channels appear on the channel list. Channels are shown with their name if this information is available.

There is a channel list with all installed channels. You can only filter this list to show TV or only Radio channels.

With a channel list selected, press ▲/▼ key to select a channel, then press **OK** key to watch the selected channel. You can page up or page down the channels in that list when using **CH-/CH+** key.

Radio stations

If digital broadcasting is available, digital radio stations are installed during installation. Switch to a radio channel just like you switch to a TV channel.

Open a channel list

To open the current channel list..

Press **SOURCE** Key to switch to TV mode (DTV or ATV).

Press **LIST** key to open the current channel list.

Press **LIST** key again to close the channel list.

Filter a channel list

You can filter a list with all channels. You can set the channel list to show only TV channels or only Radio stations.

To set a filter list with all channels.

1. While watching a TV channel.
2. Press ◀/▶ key to select a list.
3. You can select ALL, DTV or ATV, HD, Radio list etc.

Watching TV channels

Tune to a channel

To watching TV channels, press **SOURCE** key to show signal menu, you can select Satellite, DTV, ATV and press **OK** key to enter.

Switch channels

To switch channels, press **CH-/CH+** key.

If you know the channel number, type in the number in current TV channel, then the TV will auto Switch the number channel by you typed.

Previous channel

To switch back to the previous tuned channel, press **BACK** key to return the previous channel

Radio channel

If digital broadcasting is available, digital radio stations are installed during installation. Switch to a radio channel just like you switch to a TV channel.

About move Channels

1. While you watching TV, press **MENU** key and select CHANNEL, press **OK** key to enter.
2. In channel menu, select Channel Edit and press **OK** key to enter into channel list.
3. In channel list, you can press ▲/▼ key to select your channel, press → key on the remote control to move channel, and press ▲/▼ key to move it.
4. Press **OK** key confirm

Lock a channel

Lock and unlock a channel

To prevent children from watching a channel or a programme, you can lock channels or lock age Rated programme.

You can lock a channel to prevent children from watching it. To watching a lock channel you need to enter the lock code. You can't lock programmes from connected devices.

To set the lock channel

1. While watching TV channels, press **MENU** key and select LOCK, press **OK** key to enter.
2. Input the code in lock system to log in, select channel lock and press **OK** key to enter the channel list.
3. Press ▲/▼ key to select your channel and press → key on the remote control to lock the channel, press → key again to unlock the channel.

Parental Guidance

To prevent children from watching a programme not suitable for their age, you can use Parental Guidance.

Some digital broadcasters have age rated their programmes. When the age rating of a programme is equal to or higher than the age you have set as age rating for your child, the programme will be locked.

To set an age rating..

1. While watching TV channels, press **MENU** key and select LOCK, press **OK** to enter.
2. Input the code in lock system to log in, select Parental Guidance and press **OK** key to enter.
3. Press ◀/▶ key to select your age rating.

The TV will ask for the code to unlock the programme. For some broadcasters/operators, the TV only locks programme with a higher rating.

Favourite Channels

About Favourite Channels

You can create a favourite channel list that only holds the channels you want to watch. With The Favourite channel list selected, you will only see your favourite channels when you switch Through channels.

Create a Favourite list

1. While you watching TV, press **MENU** key and select CHANNEL, press **OK** key to enter.
2. In channel menu, select Channel Edit and press **OK** key to

enter into channel list.

3. In channel list, you can press ▲/▼ key to select your channel, long press **—** key on the remote control to set your favourite channel, and long press **—** key again to cancel it.

4. Press **BACK** key to return the current channel, you can long press **—** key to show the Favourite list.

Rename channel

1. While you entering ATV channel, press **MENU** key and select CHANNEL, press **OK** key to enter.

2. In channel menu, select Channel Edit and press **OK** key to enter into channel list.

3. You can press ▲/▼ key to select your channel, press **—** key on the remote control to rename the channel.

4. Press **OK** key to confirm the channel name.

Open channel menu

Press **MENU** key on the remote control, then press ◀/▶ key to select CHANNEL on the screen, press **OK** key to enter the channel menu.

Channel

Channel installation-Antenna, Cable

Update channels

Programme scanning

Before you watching the programs of the TV, you need to scan the programs. (Note: Make sure that the antenna is connected properly before scanning).

Auto Tuning

Press **MENU** key to enter the main menu and select CHANNEL, press **OK** key to enter channel menu, select Auto Tuning, press ▶ key to open tuning setup. You can press ▲/▼ key to adjust these options, and then press **OK** key to start searching.

ATV Manual Tuning

Select CHANNEL, press **OK** key to enter channel menu, select ATV Manual Tuning, then press ▶ key to enter submenu. You can press ▲/▼ key to select the item to set, and then press ◀/▶ key to adjust the options or search the channels by manual.

DTV Manual Tuning

Select CHANNEL, press **OK** key to enter channel menu, select DTV Manual Tuning, then press ◀/▶ key to select channel, press **OK** key to start searching.

Channel installation-Satellite

Watching Satellite Channel

Press **SOURCE** key on the remote control to show menu.

Press ▲/▼ key to select Satellite, and press **OK** key to enter Satellite channel.

Satellite Channel installation

Before you watching satellite channel, you have to install satellite channel. This TV has a built-in satellite DVB-S/S2 receiver. Connect the cable from your satellite dish directly to the TV. Use a coaxial cable fit for connecting a satellite antenna dish. Make sure your satellite dish is perfectly aligned before you start installation.

To install satellite channel...

1. Press **SOURCE** key and select Satellite, then press **OK** key

to enter satellite signal.

2. Press **MENU** key and select Channel, then press **OK** key to enter channel menu.

3. Select Auto tuning and press **OK** key to enter Tuning Setup menu. You can press ▲/▼ key to select Country, Satellite, Scan Mode, Channel Type, Service; and press ◀/▶ key adjust these options, then press **OK** key to start tuning.

4. The TV will search for satellites available on the alignment of your antenna dish. This may

Take a few minutes. When the tuning was finished, the channel will store in channel list, you can press **CH LIST** key on the remote control to show these information.

Tips: Press **MENU** key to exit tuning.

Channel Edit

Select CHANNEL, press **OK** key to enter channel menu, select Channel Edit, press **OK** key enter channel list, press ▲/▼ key to select the item you'd like to edit. You can select the color keys to edit these programmes with the tips on the screen.

Delete: Press **—** key on the remote control to delete the selected channel.

Move: Press **—** key on the remote control to highlight a channel, and press ▲/▼ key to move, then press **—** key to confirm location.

Skip: Press **—** key on the remote control to skip the channel, and press **—** key again to cancel it.

Favourite: Long press **—** key on the remote control to set your favourite channel, and long press **—** key again to cancel it.

Schedule List

Select CHANNEL, press **OK** key to enter channel menu, select Schedule List, Press **OK** key to look through the Channel schedule list information or Recorded list information (it is available only in DTV mode).

Signal information

Select CHANNEL, press **OK** key to enter channel menu, select Signal information, Press **OK** key to look through the signal information (it is available only in DTV mode).

CI information

Select CHANNEL, press **OK** key to enter channel menu, select CI information, Press **OK** key to look through the CI information (it is need CI CAM).

Software Update(OAD)

Select Off or On.

Dish Setup

Manual Installation

Press ▲/▼ key to select Dish Setup, then press **OK** key to enter the satellite channel Manual installation.

Add a satellite

In the Dish Setup menu, press ◀/▶ key to highlight left, middle or right column. When the satellite is highlighted, you can press **EXIT** key to return previous menu.

1. Press **—** key on the remote control to enter Add menu.

Satellite Name: Press ▶ navigation key to enter rename page. Use navigation keys to set a new complete name.

Longitude Direction: Press ◀/▶ navigation key to select desired option.

Longitude Angle: Press ◀/▶ key navigation key to move the cursor and press number keys on the remote control to input desired value.

Band: Press ◀/▶ navigation key to select desired option.
 2. Press — key on remote control to enter Edit menu. The operations of Edit menu are the same as Add menu.
 3. Press — key on the remote control to enter Scan menu. Press ▲/▼ navigation key to select your desired item. Press ◀/▶ navigation key to set Channel Search, such as: Scan Mode, Channel Type and Service Type.
 4. Press — key on the remote control to delete the selected satellite.

Transponder Setup

Press **TV GUIDE** key on the remote control to switch satellite and Transponder.

1. Press — key on remote control to enter Add menu.

Frequency: Press ◀/▶ navigation key to move the cursor and press number keys on remote control to input desired value.

Symbol (ks/s): Press ◀/▶ navigation key to move the cursor and press number keys on remote control to input desired value.

Polarity: Press ◀/▶ navigation key to select desired option.

2. Press — key on remote control to enter Channel Search menu. Press ▲/▼ navigation key to select your desired item. Press ◀/▶ navigation key to set Channel Search, such as: Scan Mode, Channel Type and Service Type.

Ku_HOTBIRD Setup

When the Ku_HOTBIRD is selected, you can press ▲/▼ navigation key to select these Item.

LNB (Low Noise Block) Type

Press ◀/▶ navigation key to enter submenu. Then press ▲/▼ navigation key to select desired option.

LNB Power

Press ◀/▶ navigation key to select desired option.

22 kHz

Press ◀/▶ navigation key to select desired option.

Toneburst

Press ◀/▶ navigation key to select desired option.

DisEqc1.0 (Digital Satellite Equipment Control)

Press ◀/▶ navigation key to select desired option.

DisEqc1.1

Press ◀/▶ navigation key to select desired option.

Motor

Press ◀/▶ navigation key to select desired option.

TV Program Guide

What you need

With the TV guide you can View a list of the current and scheduled TV programmes of your channels. Depending on where the TV guide information (date) is coming from, analogue and digital channels or only digital channels are shown. Not all channels offer TV guide information.

The TV can collect TV guide information for the channels that are installed on the TV (eg: the channels you watch with TV). The TV can't collect the TV guide information for channels viewed from a digital receiver.

Using the TV Program guide

Open the TV guide

Press **TV GUIDE** key to access TV program guide list (it is available only in DTV mode). You can select the color keys to edit these programmes with the tips on the screen. The color keys function introduce as below:

Record

Press — key on the remote control to record the programmes you wished.

Remind

You can press — key on the remote control to set remind the programmes you wished.

Prev Day

Press — key on the remote control to view programmes list of the previous day.

Next Day

Press — key on the remote control to view programmes list of the next day.

Recording and Time-shift

Recording

What you need

You can record a digital TV broadcast and watch it later.

To record a TV programme you need...

1. A connected USB Hard Drive formatted on this TV.
2. Digital TV channels installed on this TV.
3. To receive channel information for the TV Guide on screen.
4. A reliable TV clock setting, If you reset the TV clock manually,

the recording may fail.

You can't record when you are using Time-shift function.

In terms enforcement of copyright legislation, some DVB providers can apply different restriction by means of DRM (Digital Right Management) technology. In case of broadcasting protected channels, recording, record validity or number of views may be restricted.

Recording may be completely prohibited, in case of trying to record a protected broadcasting or play back an expired recording, an error message can appear.

Record a programme

In DTV mode, press **●** (Record) key to begin recording the programme. The recording function need connect with a USB Hard Drive formatted on the TV.

To record the programme you are watching right now, press **●** (Record) key on the remote control, then the recording will start immediately. When the programme was recording, you can select **■** key to stop it.

Schedule a recording

You can view and manage your recordings in the list of recording. Next to the list of recordings, there is a separate list for scheduled recordings and reminders.

Open or delete the list of recording

Select CHANNEL, press **OK** key to enter channel menu, select Schedule List, Press **OK** key to look through the Channel schedule list information or Recorded list information, press **◀/▶** key to select schedule list or Recorded list. Press **▲/▼** key to select the recordings, and press **OK** key to play or press **—** key on remote control to delete the selected recording file. You can press **EXIT** key to quit the list.

Time-shift

What you need

You can use Time-shift function and resume watching it a bit later.

Use Time-shift function you need...

1. A connected USB Hard Drive formatted on this TV.
2. Digital TV channels installed on this TV.
3. To receive channel information for the TV Guide on screen.

With the USB Hard Drive connected and formatted the TV continuously stores the TV

Broadcast you are watching. When you switch to another channel, the broadcast of the former channel is cleared. Also when you switch the TV to standby the broadcast is cleared.

You can't use Time-shift function when you are recording.

Use Time-shift for a programme

In DTV mode, press **⏸** key on the remote control, time-shift option menu will show on the screen, and the program is in suspended status. press **■** key on the remote control to stop and

quit time-shift function. When you leave program for a short time, time-shift function can suspend and cache the playing program to U disk. When you resume playing, the program can continue to be played.

Replay

Since the TV stores the broadcast you are watching, you can mostly replay the broadcast for a few seconds.

When you pause the programme, you can press **▶** (play) key to play normally.

Sources

Switch a device signal

In the list of connections-the Source menu-you can find the devices connected to the TV. From this Source menu, you can switch to a device.

Source menu

To open the sources menu, press **SOURCE** key on the remote control. And then press **▲/▼** key to select the connected device, press **OK** key to enter the signal source.

From standby

With the TV in standby, you can switch on a connected device with your TV remote control.

Play

To switch on both disc player and TV from standby and start playing the disc or programme immediately, press **▶** (play) key on the remote control.

The device should be with an HDMI cable and both TV and device must have HDMI CEC switched on.

EasyLink

With EasyLink you can operate a connected device with the TV remote control. EasyLink uses HDMI CEC to communicate with the connected devices. Devices must support HDMI CEC and must be connected an HDMI connection.

Time

Time settings

Sleep timer

With the sleep timer, you can set the TV to switch to standby automatically after a preset time.

To set the sleep timer...

1. Press **MENU** key on the remote control, then press ◀/▶ key to select **TIME** on the screen, press **OK** key to enter the **TIME** menu.

2. Press ▲/▼ key select **Sleep Timer**, then press ◀/▶ key to adjust the value of standby time: Off, 15minute, 30minutes, 45minutes, 60minutes, 90minutes, 120 minutes, 240 minutes.

Disable TV sleep timer:

Select the **Off** on the screen, then close the TV sleep timer.

Time Zone

Press ▲/▼ key select **Time Zone**, then press ◀/▶ key to adjust the time zone of different country.

Auto Standby

Press ▲/▼ key select **Auto Standby**, then press ◀/▶ key to adjust the time: Off, 3hours, 4hours, 5hours.

OSD Timer

Press ▲/▼ key select **OSD Timer**, then press ◀/▶ key to adjust the menu display time (5 Seconds, 15Seconds, 30 Seconds).

Summer Time

Press ▲/▼ key select **Summer Time**, then press ◀/▶ key to adjust the **Summer Time**: On, Off, Auto.

LOCK

System Lock

Select turn on/off lock system. Block program option can work when it is on state (The default password: 0000).

Set Password

Set new password.

Channel Lock

Press **—** key to lock the programme in the channel list. You need input the right password to view the programme when it is locked.

Parental Guidance

Adjust the programme blocking level, this function help Parents block unsuitable channel for their child age.

Key Lock

Select the **Key Lock** on or off.

SETTING

General Settings

Language

Select a language for the TV system.

TTX Language

Select the language for Text/Teletext.

Audio Language

Select the language for audio if the programme is available.

Subtitle Language

Select the subtitle language if the programme is available.

Hearing impaired

Select the **Hearing impaired** on or off.

PVR file system

Manage the USB device for the recording programme.

Aspect ratio

Adjust aspect ratio as: Zoom1, Zoom2, Auto, 4:3, 16:9.

Blue screen

Turning on blue screen option **ON** will enable the TV screen to turn blue when there are no signal input.

First time installation

When the TV was the first time installed, you can setup language, country, environment, auto tuning.

Reset

Resetting the TV will cause all the settings to return to factory default status.

Software Update (USB)

Upgrade software with the USB interface.

HDMI CEC-Easylink

Setup the HDMI CEC options.

Help

Enter the operation guide.

PICTURE

Picture Setting

Press **MENU** key to show main menu, select Picture icon and press **OK** key to enter.

Picture Mode: press ◀/▶ key to set the picture display mode such as: Personal, Vivid, Standard, Mild.

Contrast: press ◀/▶ key to adjust contrast value of picture (0~100).

Brightness: press ◀/▶ key to adjust brightness value of picture (0~100).

Colour: press ◀/▶ key to adjust colour value of picture (0~100).

Tint: press ◀/▶ key to adjust Tint value of picture (it is available only in NTSC system).

Sharpness: press ◀/▶ key to adjust sharpness value of picture (0~100).

Colour Temp: press ◀/▶ key to set colour temperature of picture such as: Cool, Normal, Warm.

Noise Reduction: press ◀/▶ key to set noise reduction of picture such as: Off, Low, Middle, High, Default.

HDMI Mode: press ◀/▶ key to set the picture of HDMI Mode.

SOUND

Sound Setting

Press **MENU** key to show main menu, select Sound icon and press **OK** key to enter.

Sound Style: press ◀/▶ key to set the sound display mode such as: Standard, Music, Movie, Sports, Personal.

Treble: press ◀/▶ key to adjust treble value of sound (0~100).

Bass: press ◀/▶ key to adjust bass value of sound (0~100).

Balance: press ◀/▶ key to adjust balance value of sound (-50~50).

Auto Volume Level: press ◀/▶ key to turn on or off the auto volume level.

SPDIF Mode: press ◀/▶ key to select the SPDIF Mode of sound, such as: PCM, Auto, Off.

AD Switch: press ◀/▶ key to turn on or off the AD Switch.

MULTIMEDIA

From a USB connection

Insert a USB device, press **SOURCE** key or **MENU** key to display menu, select MULTIMEDIA, and press **OK** key to enter multimedia player.

Note: If want to exit MULTIMEDIA, please re-select the source.

Photo

In the multimedia menu, press ◀/▶ key to select Photo, and press **OK** key enter. You can press ◀/▶/▲/▼ key to select the picture in the File folder, then press **START**(▶) key on the remote control to play the picture.

Picture player menu options:

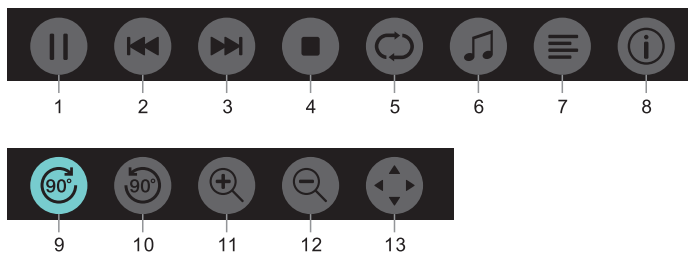

1. Play / Pause : Play / pause lantern slide.
2. Prev. : Play the previous picture.
3. Next: Play the next picture.
4. Stop: Stop playing picture and return back to previous menu.
5. Repeat: Repeat playing picture: repeat1, repeat all, repeat none.
6. Music: Play background music.
7. Playlist: Show play photo list.
8. Info: Display information of photo.
9. Rotate: Clockwise rotation photo.
10. Rotate: Counter-clockwise rotation photo.
11. Zoom in: Enlarge the photo.
12. Zoom out: Reduce the photo.
13. Move view: If the picture big enough to surpasses the screen, you may use this function to move the picture.

Music

In the multimedia menu, press ◀/▶ key to select Music, and press **OK** key enter. You can select the music in the File folder, and press **START**(▶) key to play on the remote control.

Music player menu options:

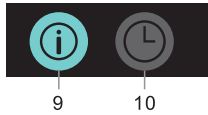

1. Play/Pause: Play / pause music.
2. FB: Press this key to fast back of the music, press **START**(▶) key to play normally.
3. FF: Press this key to fast forward of the music, press **START**(▶) key to play normally.
4. Prev.: Play the previous music.
5. Next: Play the next music.
6. Stop: Stop playing music and return back to previous menu.
7. Repeat: Repeat playing music: repeat1, repeat all, repeat none.
8. Playlist: Show play music list.
9. Info: Display information of music.
10. Time picker: Select the time to play the music.

Movie

In the multimedia menu, press ◀/▶ key to select Movie, and press **OK** key enter. You can select the movie in the File folder, and press **START**(▶) key to play on the remote control.

Video player menu options:

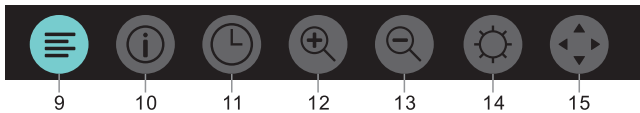
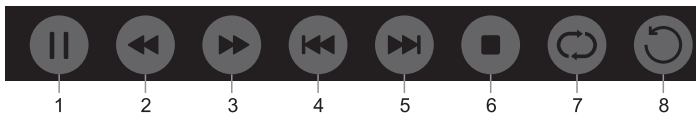

1. Play / Pause: Play / pause the video.
2. FB: Press this key to fast back of the video, press **START**(▶) key to play normally.
3. FF: Press this key to fast forward of the video, press **START**(▶) key to play normally.
4. Prev.: Play the previous video.
5. Next: Play the next video.
6. Stop: Stop playing video and return back to previous menu.
7. Repeat: Repeat playing video: repeat1, repeat all, repeat none.
8. SET A-B: Set A and B, the film will circulating play in the time of A to B.
9. Playlist: Show play video list.
10. Info: Display information of video.
11. Time picker: Select the time to play the video.
12. Zoom in: Enlarge the photo.
13. Zoom out: Reduce the photo.
14. Aspect Ratio: Adjust the aspect ratio: zoom1, zoom2, auto, 4:3, 16:9.
15. Move view: If the picture big enough to surpasses the screen, you may use this function to move the picture.

TEXT

The text menu options is same as Photo, please refer to photo options.

In the multimedia menu, press ◀/▶ key to select TEXT, and press **OK** key enter. You can select the TEXT in the File folder, and press **START**(▶) key to play on the remote control.

1. Press ◀/◀◀ key to select the last page.
2. Press ▶/▶▶ key to select the next page.

Specification information

Display resolutions

Computer Formats: Resolution-refresh rate:

HD	FHD
720×400 70Hz	640×480 60Hz
640×480 60Hz	800×600 60Hz
800×600 60Hz	1024×768 60Hz
1024×768 60Hz	1360×768 60Hz
1360×768 60Hz	1920×1080 60Hz

Video Formats: Resolution-refresh rate:

480i -60Hz
480p -60Hz
576i -50Hz
576p -50Hz
720p -50Hz, 60Hz
1080i -50Hz, 60Hz
1080p -50Hz, 60Hz

Multimedia

Supported storage device: USB (only FAT or FAT 32 USB storage devices are supported)

Compatible multimedia file formats:

Image: JPEG

Audio: Mp3

Video: MPEG 2 / MPEG4, H.264

Sound power

8W×2

Display resolution

32PHS4001 / 32PHT4001 / 32PHS4012 : 1366×768
42PFS4012 / 43PFS4001 / 43PFT4001 / 43PFS4012
/49PFS4001 / 49PFT4001 / 50PFS4012 : 1920×1080

Tuner/Reception/Transmission

Aerial input: 75 ohm coaxial (IEC75)

Supported Systems:

ATV: PAL, SECAM, NTSC

DTV: DVB-T/C/T2

Remote Control

Batteries: 2×AAA

Power Supply

Main Power Supply: 100-240V~, 50/60Hz

Standby Energy Consumption: ≤0.5W

Environment Temperature: 5-40 °C

Power Consumption:

32PHS4001 / 32PHT4001: 55W

32PHS4012 : 65W

42PFS4012 / 43PFS4001 / 43PFT4001 / 43PFS4012 : 75W

49PFS4001 / 49PFT4001: 110W

50PFS4012 : 108W

Dimensions and weights

32PHS4001 / 32PHT4001

Without base

Dimension (W×H×D) : 732×430×76(mm)

Weight: 4.4Kg

With base

Dimension (W×H×D): 732×474×193(mm)

Weight: 4.5Kg

32PFS4012

Without base

Dimension (W×H×D) : 732×432×76(mm)

Weight: 4.0Kg

With base

Dimension (W×H×D): 732×492×183(mm)

Weight: 4.0Kg

42PFS4012

Without base

Dimension (W×H×D) : 947×553×78(mm)

Weight: 6.6Kg

With base

Dimension (W×H×D): 947×610×226(mm)

Weight: 6.7Kg

43PFS4001 / 43PFT4001

Without base

Dimension (W×H×D): 970×564×75(mm)

Weight: 8.3Kg

With base

Dimension (W×H×D): 970×614×219(mm)

Weight: 8.5Kg

43PFS4012

Without base

Dimension (W×H×D): 969×567×83(mm)

Weight: 7.4Kg

With base

Dimension (W×H×D): 969×625×226(mm)

Weight: 7.5Kg

49PFS4001 / 49PFT4001

Without base

Dimension (W×H×D): 1102×639×82(mm)

Weight: 9.6Kg

With base

Dimension (W×H×D): 1102×696×258(mm)

Weight: 10.0Kg

50PFS4012

Without base

Dimension (W×H×D): 1126×655×83(mm)

Weight: 10.1Kg

With base

Dimension (W×H×D): 1126×713×226(mm)

Weight: 10.3Kg

Software

Software update

It might be necessary to update the TV software. You need a computer and a USB memory device to upload the software on the TV. Use a USB memory device with 256MB free space. Make sure that write protection is switched off.

1. Start the update on TV.

To start the software update....

Press **MENU** key, select **SETTING** and press **OK** key. Select **Software Update (USB)**, press **OK** key to start update the software.

Identify the TV.

Insert the USB memory into one of the USB connections of the TV. An identification file is written on the USB memory device.

Download the TV software.

Insert the USB memory into your computer.

On the USB memory device, select locate file and check it carefully. View the software name as below:

Model:	Software name
32PHS4001	MSD3463_S_SN51_50.bin
32PHS4012	MSD3463_S.bin
32PHT4001	MSD3463_SN51_50.bin
42PFS4012	MSD3463_S_SN51_63.bin
43PFS4001	MSD3463_S_AS358_70.bin
43PFT4001	MSD3463_AS358_70.bin
49PFS4001	MSD3463_AS358_35.bin
49PFT4001	MSD3463_AS358_35.bin
50PFS4012	MSD3463_S_AS358_60.bin

After download these files, and copy them onto the USB memory device. Do not place the file in a folder.

- Insert the USB memory device to the TV.
- Press **MENU** key to show Main menu, select **SETTING** and press **OK** key to enter.

• Select **Software Update (USB)**, press **OK** key and select **YES**, the TV will upgrade software automatically.

• When the upgrade process is complete 100%, the TV will automatically restart the boot up.

Update the TV software

The update starts automatically. The TV itself off for about a minutes and then back on again, please wait.

Notice:

- Do not use the remote control.
- Do not remove the USB memory device from the TV.
- Please keep the power stable during the upgrade software, if it suddenly power off will damage for the TV.

Open source software

This television contains open source software. TP Vision Europe B.V. hereby offers to deliver, upon request, a copy of the complete corresponding source code for the copyrighted open source software packages used in this product for which such offer is requested by the respective licenses.

This offer is valid up to three years after product purchase to anyone in receipt of this information. To obtain the source code, please write in English to this email address open.source@tpvision.com.

Open source license statement

Acknowledgements and License Texts for any open source software used in this Philips TV.

This is a document describing the distribution of the source code used on the Philips TV, which fall either under the GNU

General Public License (the GPL), or the GNU Lesser General Public License (the LGPL), or any other open source license. Instructions to obtain source code for this software can be found in the user manual.

PHILIPS MAKES NO WARRANTIES WHATSOEVER, EITHER EXPRESS OR IMPLIED, INCLUDING ANY WARRANTIES OF MERCHANTABILITY OR FITNESS FOR A PARTICULAR PURPOSE, REGARDING THIS SOFTWARE. Philips offers no support for this software. The preceding does not affect your warranties and statutory rights regarding any Philips product(s) you purchased. It only applies to this source code made available to you.

This television contains open source software. TP Vision Europe B.V. hereby offers to deliver, upon request, a copy of the complete corresponding source code for the copyrighted open source software packages used in this product for which such offer is requested by the respective licenses. This offer is valid up to three years after product purchase to anyone in receipt of this information. To obtain the source code, please write in English to...

Intellectual Property Dept.
TP Vision Europe B.V.
Prins Bernhardplein 200
1097 JB Amsterdam

Troubleshooting and support

General issues

The TV cannot be switched on:

- Disconnect the power cable from the power outlet. Wait for one minute before reconnecting it.
- Check that the power cable is securely connected.

The remote control is not working properly:

- Check that the remote batteries are correctly inserted according to the "+/-" orientation.
- Replace the remote control batteries if they are flat or weak.
- Clean the remote control and TV sensor lens.

The TV menu is in the wrong language:

- Change the TV menu to your preferred language.

When turning the TV on /off or to standby, you hear a creaking sound from the TV chassis:

- No action is required. The creaking sound comes from the normal expansion and contraction of the TV as it cools down and warms up. This doesn't impact its performance.

Channel issues

No digital channels found during the installation:

- See the technical specifications to make sure that your TV supports DVB-T or DVB-C in your country.
- Make sure that all cables are properly connected.

Previously installed channels do not appear in the channel list:

- Check that the correct channel list is selected.

Picture issues

The TV is on, but there is no picture:

- Check that the antenna is properly connected to the TV.
- Check that the correct device is selected as the TV source.

There is sound but no picture:

- Check that the picture settings are correctly set.

Poor TV reception from the antenna connection:

- Check that the antenna is properly connected to the TV.
- Loudspeakers, unearthed audio devices, neon lights, high buildings and other large objects can influence reception quality. If possible, you try to improve the reception quality by changing the antenna direction or moving devices away from the TV.
- If the reception on one particular channel is poor, please fine tune this channel.

There is poor picture quality from connected devices:

- Check that the devices are connected properly.
 - Check that the picture settings are correctly set.
- The picture does not fit the screen; it is too big or too small:
- Try using a different picture format.

The picture position is incorrect:

- Picture signals from some devices may not fit the screen correctly. Please check the signal output of the device.

Sound issues

The pictures are showing but sound quality is poor:

- Check that cables are properly connected.
- Check that the volume is not set to 0.
- Check that the sound is not muted.
- Check that the sound settings are correctly set.

The pictures are showing but sound comes from one speaker only:

- Verify that sound balance is set to the centre.

HDMI connection issues

There are problems with HDMI devices:

- Please note that HDCP (High-bandwidth Digital Content Protection) support can delay the time taken for a TV to display content from a HDMI device.
 - If the TV does not recognition the HDMI device and on picture is displayed, please try switching the signal source to another device before switching it back again.
 - If there are intermittent sound disruptions, please check that output settings from the HDMI device are correct.

Computer connection issues

The computer display on the TV is not stable:

- Check that your PC uses the supported resolution and refresh rate.
- Set the TV picture format to display scale.

Contact us

If you cannot resolve your problem, please refer to the FAQs for this model at www.philips.com/support.

If the problem remains unresolved, please contact your local Philips Customer Service Center.

Warning

Do not attempt to repair the TV yourself. This may cause severe injury, irreparable damage to your TV or void your warranty.

Note:

Please make a note of your TV model and serial number before you contact Philips Customer Service Center. These numbers are printed on the back/bottom of the TV and on the packaging.

Term of use, copyrights and licenses

Term of use

2017©TPVision Europe B.V. All rights reserved. Specifications are subject to change without notice. Trademarks are the property of Koninklijke Philips N.V or their respective owners. TPVision Europe B.V. reserves the right to change products at any time without being obliged to adjust earlier supplies accordingly.

The material in this manual is believed adequate for the intended use of the system. If the product, or its individual modules or procedures, are used for purposes other than those specified herein, confirmation of their validity and suitability must be obtained. TPVision Europe B.V. warrants that the material itself does not infringe any United States patents. No further warranty is expressed or implied.

TPVision Europe B.V. cannot be held responsible neither for any errors in the content of this document nor for any problems as a result of the content in this document. Errors reported to Philips will be adapted and published on the Philips support website as soon as possible.

Copyrights and Licenses

HDMI:  HIGH-DEFINITION MULTIMEDIA INTERFACE

MHL: 

Dolby: 

www.philips.com/support

България

Грижа за клиента
02 4916 273
 (Национален номер)

België/Belgique

Klantenservice/
 Service Consommateurs
02 700 72 62
 (0.15€/min.)

Bosna i Hercegovina

Potpora potrošačima
033 941 251
 (Lokalni poziv)

Republika Srbija

Potpora potrošačima
011 321 6840
 (Lokalni poziv)

Česká republika

Zákaznická podpora
228 880 895
 (Místní tarif)

Danmark

Kundeservice
3525 8314

Deutschland

Kundendienst
069 66 80 10 10
 (Zum Festnetzstarif ihres
 Anbieters)

Ελλάδα

Τμήμα καταναλωτών
2111983028
 (Διεθνής κλήση)

Eesti

Klienditugi
668 30 61
 (Kohalikud kõned)

España

Atención al consumidor
913 496 582
 (0,10€ + 0,08€/min.)

France

Service Consommateurs
01 57 32 40 50
 (coût d'un appel local sauf
 surcoût éventuel selon
 opérateur réseau)

Hrvatska

Potpora potrošačima
01 777 66 01
 (Lokalni poziv)

Indonesia

Consumer Care
0800 133 3000

Ireland

Consumer Care
015 24 54 45
 (National Call)

Italia

Servizio Consumatori
0245 28 70 14
 (Chiamata nazionale)

Қазақстан Республикасы

байланыс орталығы
810 800 2000 00 04
 (стационарлық нөмірлерден
 Қазақстан Республикасы
 бойынша қоңырау шалу тегін)

Latvija

Klientu atbalsts
6616 32 63
 (Vietēiais tarifs)

Lietuva

Klientų palaikymo tarnyba
8 521 402 93
 (Vietiniais tarifais)

Luxembourg

Service Consommateurs
2487 11 00
 (Appel nat./Nationale Ruf)

Magyarország

Ügyfélszolgálat
(061) 700 81 51
 (Belföldi hívás)

Malaysia

Consumer Care
1800 220 180

Nederland

Klantenservice
0900 202 08 71
 (1€/gesprek)

Norge

Forbrukerstøtte
22 97 19 14

Österreich

Kundendienst
0150 284 21 40
 (0,05€/Min.)

Республика Беларусь

Контакт Центр
8 10 (800) 2000 00 04
 (бесплатный звонок по
 Республике Беларусь со
 стационарных номеров)

Российская Федерация

Контакт Центр
8 (800) 220 00 04
 (бесплатный звонок по
 России)

Polska

Wsparcie Klienta
22 397 15 04
 (Połączenie lokalne)

Portugal

Assistência a clientes
800 780 068
 (0,03€/min. – Móvel
 0,28€/min.)

România

Serviciul Clienți
031 630 00 42
 (Tarif local)

Schweiz/Suisse/Svizzera

Kundendienst/ Service
 Consommateurs/Servizio
 Consumatori
0848 000 291
 (0,04 CHF/Min)

Slovenija

Skrb za potrošnike
01 88 88 312
 (Lokalni klic)

Slovensko

Zákaznická podpora
02 332 154 93
 (vnútroštátny hovor)

Suomi

Finland Kuluttajapalvelu
09 88 62 50 40

Sverige

Kundtjänst
08 57 92 90 96

Türkiye

Tüketici Hizmetleri
0 850 222 44 66

Україна

Служба підтримки
 споживачів
0-800-500-480
 (дзвінки зі стаціонарних
 телефонів безкоштовні)

United Kingdom

Consumer Care
020 79 49 03 19
 (5p/min BT landline)

Argentina

Consumer Care
0800 444 77 49
 - Buenos Aires
0810 444 7782

Brasil

Suporte ao Consumidor
0800 701 02 45
 - São Paulo
29 38 02 45



All registered and unregistered trademarks are property of their respective owners. Specifications are subject to change without notice. Philips and the Philips' shield emblem are trademarks of Koninklijke Philips N.V. and are used under license from Koninklijke Philips N.V. 2017 © TP Vision Europe B.V. All rights reserved.
philips.com