

**PHILIPS**

Televisions

3000 series

24PFL3603



Register your product and get support at

[www.philips.com/welcome](http://www.philips.com/welcome)

---

EN **User manual**

---

ES **Manual del usuario**

---

FR **Manuel d'utilisation**

---

EN **For further assistance, call the customer support service in your country.**

- To obtain assistance, contact Philips customer care center; In the U.S.A., Canada, Puerto Rico, or the U.S. Virgin Islands **1 866 813 3283**  
Mexico city and Metropolitan area; **58 87 97 36**  
Interior de la republica; **01 800 839 19 89**

ES **Para obtener más información, llame al centro de atención a clientes de su país.**

- Para obtener asistencia, comuníquese con centro de atención al cliente de Philips;  
En los Estados Unidos, en Canadá, Puerto Rico o en las Islas Vírgenes de los Estados Unidos; **1 866 813 3283**  
CDMX y Área metropolitana; **58 87 97 36**  
Interior de la republica; **01 800 839 19 89**

FR **Pour obtenir de l'aide supplémentaire, communiquez avec le centre de service à la clientèle de votre pays.**

- Pour obtenir de l'aide, communiquez avec le centre de service à la clientèle Philips au;  
Dans le États-Unis, au Canada, à Puerto Rico ou aux Îles Vierges américaines; **1 866 813 3283**  
Mexico et Zone métropolitaine; **58 87 97 36**  
Interior de la republica; **01 800 839 19 89**

# Contents

<b>1 Notice</b>	5	<b>4 Getting the most from your TV</b>	20
<b>2 Getting started</b>	7	Displaying the main menu	20
Features	7	<b>PICTURE</b>	21
Included accessories	7	<b>SOUND</b>	22
Symbols used in this User manual	7	<b>CHANNEL</b>	23
Installing the stands	8	Air/Cable	23
Installing the remote control batteries	8	Auto Scan	23
Remote control	9	Favorite	24
Control panel	10	Channel List	24
Terminals	10	Show/Hide	24
Connecting antenna or cable / satellite set-top box	11	Channel Number	24
Plugging in the AC power cord	11	Channel Label	24
Selecting your connection quality	12	<b>LOCK</b>	25
Connecting your devices	12	Change Password	25
Setup wizard	15	Key Lock	25
<b>3 Use your TV</b>	16	System Lock	25
Switching on your TV and putting it in standby mode	16	Child and ratings lock	25
Adjusting volume	16	RRT Setting	26
Switching channels	16	<b>TIME</b>	27
Watching channels from an external device	17	Sleep Timer	27
Sleep timer	17	Time Zone	27
Switching audio mode	17	Daylight Saving Time	27
Create a list of favorite channels	18	Time Format	27
Changing picture format	18	Auto Clock	27
TV screen information	19	Clock	27
		<b>SETUP</b>	28
		Menu Language	28
		Transparent	28
		OSD Timeout	28
		Closed Caption	28
		Over Scan	30
		Source Label	30
		Other Settings	30
		Restore Default	30
		Setup Wizard	30
		CEC	31
		Voice Guidance	31
		Video Description	31
		E-sticker	31
		<b>MULTIMEDIA</b>	32
		<b>5 Useful tips</b>	33
		FAQ	33
		Troubleshooting tips	34
		<b>6 Information</b>	35
		Glossary	35
		Maintenance	35
		<b>7 Specifications</b>	36
		<b>8 Warranty</b>	37

**Register online today at [www.philips.com/welcome](http://www.philips.com/welcome) today to get the most benefits from your purchase.**

Registering your model with Philips makes you eligible for all of the valuable benefits listed below, so don't miss out. Register online at [www.philips.com/welcome](http://www.philips.com/welcome) to ensure:

### \*Product safety notification

By registering your product, you'll receive notification - directly from the manufacturer - in the rare case of a product recall or safety defect.

### \*Additional benefits

Registering your product guarantees that you'll receive all of the privileges to which you're entitled, including special money-saving offers.

Know these **safety** symbols



The caution marking is located on the rear or bottom of the cabinet.



The lightning flash with arrowhead symbol, within an equilateral triangle, is intended to alert the user to the presence of uninsulated "dangerous voltage" within the apparatus's enclosure that may be of sufficient magnitude to constitute a risk of electric shock to persons.



The exclamation point within an equilateral triangle is intended to alert the user to the presence of important operating and maintenance (servicing) instructions in the literature accompanying the apparatus.

**WARNING:** To reduce the risk of fire or electric shock, do not expose this apparatus to rain or moisture. Apparatus shall not be exposed to dripping or splashing and no objects filled with liquids, such as vases, shall be placed on the apparatus.

**CAUTION:** To prevent electric shock, match wide blade of plug to wide slot, fully insert.

**PHILIPS**

For fastest support visit us online for chat and self service solutions at [www.philips.com/support](http://www.philips.com/support)

## CHILD SAFETY:

### PROPER TELEVISION PLACEMENT MATTERS

#### THE CONSUMER ELECTRONICS INDUSTRY CARES

- Manufacturers, retailers and the rest of the consumer electronics industry are committed to making home entertainment safe and enjoyable.
- As you enjoy your television, please note that all televisions – new and old- must be supported on proper stands or installed according to the manufacturer's recommendations. Televisions that are inappropriately situated on dressers, bookcases, shelves, desks, speakers, chests, carts, etc., may fall over, resulting in injury.

#### TUNE IN TO SAFETY

- **ALWAYS** follow the manufacturer's recommendations for the safe installation of your television.
- **ALWAYS** read and follow all instructions for proper use of your television.
- **NEVER** allow children to climb on or play on the television or the furniture on which the television is placed.
- **NEVER** place the television on furniture that can easily be used as steps, such as a chest of drawers.
- **ALWAYS** install the television where it cannot be pushed, pulled over or knocked down.
- **ALWAYS** route cords and cables connected to the television so that they cannot be tripped over, pulled or grabbed.

#### WALL OR CEILING MOUNT YOUR TELEVISION

- **ALWAYS** contact your retailer about professional installation if you have any doubts about your ability to safely mount your television.
- **ALWAYS** use a mount that has been recommended by the television manufacturer and has a safety certification by an independent laboratory (such as UL, CSA, ETL).
- **ALWAYS** follow all instructions supplied by the television and mount manufacturers.
- **ALWAYS** make sure that the wall or ceiling where you are mounting the television is appropriate. Some mounts are not designed to be mounted to walls and ceilings with steel studs or cinder block construction. If you are unsure, contact a professional installer.
- Televisions can be heavy. A minimum of two people is required for a wall or ceiling mount installation.

#### MOVING AN OLDER TELEVISION TO A NEW PLACE IN YOUR HOME

- Many new television buyers move their older CRT televisions into a secondary room after the purchase of a flat-panel television. Special care should be made in the placement of older CRT televisions.
- **ALWAYS** place your older CRT television on furniture that is sturdy and appropriate for its size and weight.
- **NEVER** place your older CRT television on a dresser where children may be tempted to use the drawers to climb.
- **ALWAYS** make sure your older CRT television does not hang over the edge of your furniture.

**CTA.tech/safety** Consumer Technology Association™

# Important safety instructions

1. Read these instructions.
2. Keep these instructions.
3. Heed all warnings.
4. Follow all instructions.
5. Do not use this apparatus near water.
6. Clean only with dry cloth.
7. Do not block any ventilation openings. Install in accordance with the manufacturer's instructions.
8. Do not install near any heat sources such as radiators, heat registers, stoves, or other apparatus (including amplifiers) that produce heat.
9. Do not defeat the safety purpose of the polarized or grounding-type plug. A polarized plug has two blades with one wider than the other. A grounding type plug has two blades and a third grounding prong. The wide blade or the third prong are provided for your safety. If the provided plug does not fit into your outlet, consult an electrician for replacement of the obsolete outlet.
10. Protect the power cord from being walked on or pinched particularly at plugs, convenience receptacles, and the point where they exit from the apparatus.
11. Only use attachments / accessories specified by the manufacturer.
12. Use only with the cart, stand, tripod, bracket, or table specified by the manufacturer, or sold with the apparatus. When a cart is used, use caution when moving the cart / apparatus combination to avoid injury from tip-over.



13. Unplug this apparatus during lightning storms or when unused for long periods of time.
14. Refer all servicing to qualified service personnel. Servicing is required when the apparatus has been damaged in any way, such as power-supply cord or plug is damaged, liquid has been spilled or objects have fallen into the apparatus, the apparatus has been exposed to rain or moisture, does not operate normally, or has been dropped.

## Note to the CATV system installer:

This reminder is provided to call the CATV system installer's attention to Article 820-40 of the NEC that provides guidelines for proper grounding and, in particular, specifies that the cable ground shall be connected to the grounding system of the building, as close to the point of cable entry as practical.

## Example of antenna grounding as per NEC - National Electric Code

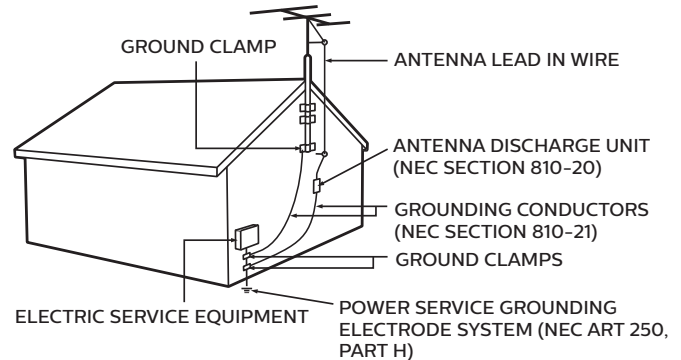

### Wall mount bracket kit

	Brand	Model #	Screw dimension
24PFL3603	SANUS	AST16-B1	M4 x 0.472" (12mm)

- Your TV meets the VESA standard for wall mounting. Consult with your local dealer for a wall mount bracket which is compatible with your TV model.
- The recommended wall mount bracket kit (sold separately) allows the mounting of the TV on the wall.
- For detailed information on installing the wall mount, refer to the wall mount Instruction book.
- Funai Corporation is not responsible for any damage to the product or injury to yourself or others if you elect to install the TV wall mount bracket or mount the TV onto the bracket on your own.
- The wall mount bracket must be installed by experts.

### Funai Corporation is not liable for these types of accidents or injuries noted below.

- Install the wall mount bracket on a sturdy vertical wall.
- If installed onto a ceiling or slanted wall, the TV and wall mount bracket may fall which could result in a severe injury.
- Do not use screws that are longer or shorter than their specified length. If screws too long are used this may cause mechanical or electrical damage inside the TV set. If screws too short are used this may cause the TV set to fall.
- Do not fasten the screws by excessive force. This may damage the product or cause the product to fall, leading to an injury.
- For safety reasons use 2 people to mount the TV onto a wall mounting bracket.
- Do not mount the TV onto the wall mounting bracket while your TV is plugged in or turned on. It may result in an electrical shock injury.

### When installing the unit on the wall, allow this much space.

Top	: 11.8 inches (30cm)
Left and right side	: 5.9 inches (15cm)
Bottom	: 3.9 inches (10cm)

# 1 Notice

Trademarks are the property of Koninklijke Philips N.V. or their respective owners.

Funai Corporation reserves the right to change products at any time without being obliged to adjust earlier supplies accordingly. The material in this Owner's manual is believed adequate for the intended use of the system. If the product or its individual modules or procedures are used for purposes other than those specified herein, confirmation of their validity and suitability must be obtained. Funai Corporation warrants that the material itself does not infringe any United States patents. No further warranty is expressed or implied. Funai Corporation cannot be held responsible neither for any errors in the content of this document nor for any problems as a result of the content in this document. Errors reported to Funai Corporation will be adapted and published on the Funai Corporation support website as soon as possible.

## Pixel characteristics

This LCD product has a high number of color pixels. Although it has effective pixels of 99.999% or more, black dots or bright points of light (red, green or blue) may appear constantly on the screen. This is a structural property of the display (within common industry standards) and is not a malfunction.

## Warranty

No components are user serviceable. Do not open or remove covers to the inside of the product. Repairs may only be done by service centers and official repair shops. Failure to do so shall void any warranty, stated or implied.

Any operation expressly prohibited in this manual, any adjustments or assembly procedures not recommended or authorized in this manual shall void the warranty.

## Federal communications commission notice

**This equipment has been tested and found to comply with the limits for a Class B digital device, pursuant to part 15 of the FCC Rules. These limits are designed to provide reasonable protection against harmful interference in a residential installation. This equipment generates, uses and can radiate radio frequency energy and, if not installed and used in accordance with the instructions, may cause harmful interference to radio communications. However, there is no guarantee that interference will not occur in a particular installation. If this equipment does cause harmful interference to radio or television reception, which can be determined by turning the equipment off and on, the user is encouraged to try to correct the interference by one or more of the following measures:**

- Reorient or relocate the receiving antenna.
- Increase the separation between the equipment and the receiver.
- Connect the equipment into an outlet on a circuit different from that to which the receiver is connected.
- Consult the dealer or an experienced radio or television technician for help.

This device complies with Part 15 of the FCC rules. Operation is subject to the following two conditions: (1) This device may not cause harmful interference, and (2) This device must accept any interference received, including interference that may cause undesired operation.

## Declaration of conformity

**Trade name** : PHILIPS  
**Responsible party** : Funai Corporation, Inc.  
**Model** : 24PFL3603  
**Address** : 19900 Van Ness Avenue, Torrance, CA 90501  
 U.S.A.  
**Telephone number** : 1 866 813 3283

## Modifications

This apparatus may generate or use radio frequency energy. Changes or modifications to this apparatus may cause harmful interference.

Any modifications to the apparatus must be approved by Funai Corporation.

The user could lose the authority to operate this apparatus if an unauthorized change or modification is made.

## Cables

Connections to this device must be made with shielded cables with metallic RFI / EMI connector hoods to maintain compliance with FCC Rules and regulations.

## Canadian notice

### CAN ICES-3 (B) / NMB-3 (B)

**Analog and digital television receiving apparatus, Canada BETS-7 / NTMR-7.**

## Positioning the TV

- Large screen TVs are heavy. 2 people are required to carry and handle a large screen TV.
- Make sure to hold the upper and bottom frames of the unit firmly as illustrated.
- Install the unit in a horizontal and stable position.
- Do not install the unit in direct sunlight or in a place subject to dust or strong vibration.
- Depending on the environment, the temperature of this unit may increase slightly. This is not a malfunction.
- When installing this unit in a temperate environment, avoid a place with rapid temperature changes.
  - Operating temperature: 41°F (5°C) to 104°F (40°C)
- This unit should not be used in a tropical environment as it has not been evaluated under such conditions.
- No objects should be placed directly on or under this unit, especially lighted candles or other flaming objects.
- Depending on your external devices, noise or disturbance of the picture and/or sound may be generated if the unit is placed too close to them. In this case, please ensure enough space between the external devices and the unit.
- Do not insert the AC power cord into the power socket outlet before all the connections are made.
- Ensure that you always have easy access to the AC power cord and outlet to disconnect the TV from the AC outlet.
- Before you move the TV, disconnect attached cables to prevent damage to connectors, especially the TV tuner.
- Be sure to unplug the AC power plug from the AC outlet before moving or carrying the unit.
- When moving the TV and then setting it down, please be careful not to pinch the AC power cord under the unit.
- Do not place this unit in an area where it may be exposed to water, oil or grease such as:
  - near a bathtub, basin, kitchen sink, washing tub, swimming pool, kitchen exhaust fan, etc., or in a damp basement.

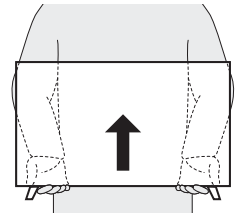

## Regulatory notices

- WARNING:** To prevent injury, this apparatus must be securely attached to the furniture / wall in accordance with the instructions. Tipping, shaking or rocking the unit may cause injury / death.
- WARNING:** Never place a TV in an unstable location. A TV may fall, causing serious personal injury or death. Many injuries, particularly to children, can be avoided by taking simple precautions such as:
- Using cabinets or stands recommended by the manufacturer of the TV.
  - Only using furniture that can safely support the TV.
  - Ensuring the TV is not overhanging the edge of the supporting furniture.
  - Not placing the TV on tall furniture (for example, cupboards or bookcases) without anchoring both the furniture and the TV to a suitable support.
  - Not placing the TV on cloth or other materials that may be located between the TV and supporting furniture.
  - Educating the children about the dangers of climbing on furniture to reach the TV or its controls.

If your existing TV is being retained and relocated, the same considerations as above should be applied.

Do not place the unit on the furniture that is capable of being tilted by a child and an adult leaning, pulling, standing or climbing on it. A falling unit can cause serious injury or even death.

In order to avoid interruption of ventilation, this unit should not be placed in built-in equipment such as a book cabinet, rack, etc., and the vents of this unit should not be covered with anything such as a tablecloth, curtain, newspaper, etc. Make sure that there is enough ventilation space (4 inches / 10 cm or more) around this unit.

Press  to turn the unit on and go into standby mode. To completely turn off the unit, you must unplug the AC power plug from the AC power outlet.

Disconnect the AC power plug to shut the unit off when trouble is found or not in use. The AC plug shall remain readily available.

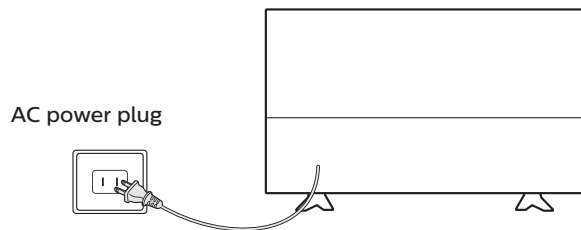

Never use a gas duster on this TV. The gas trapped inside of this unit may cause ignition and explosion.

## Environmental care



The packaging of this product is intended to be recycled. Contact your local authorities for information about how to recycle the packaging.

For product recycling information, please visit - [www.recycle.philips.com](http://www.recycle.philips.com)

## End of life directives

Philips pays a lot of attention to produce environmental-friendly products in green focal areas. Your new TV contains materials which can be recycled and reused. At the end of its life, specialized companies can dismantle the discarded TV to concentrate the reusable materials and to minimize the amount of materials to be disposed of. Please ensure you dispose of your old TV according to local regulations.

## Batteries usage

**CAUTION :** Danger of explosion if battery is incorrectly replaced. Replace only with the same or equivalent type.

**WARNING:** Batteries (battery pack or battery installed) should not be exposed to excessive heat such as sunshine, fire or the like.

- Do not mix old and new batteries.
- Do not mix alkaline, standard (carbon-zinc) or rechargeable (ni-cad, ni-mh, Li-ion, etc.) batteries.

## Disposal of used batteries

The batteries included do not contain the heavy metals mercury and cadmium, however in certain localities, disposing batteries with household waste is not permitted. Please ensure you dispose of batteries according to local regulations.

## Preparing to move / ship the unit

Please pack the unit properly by following the diagram on the carton (as noted below).

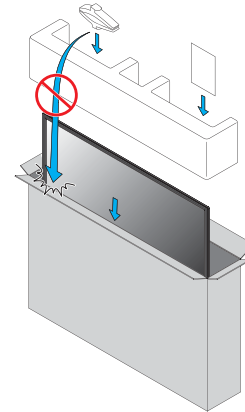

- To avoid damage to the screen, do not pack the stand on the same side as the TV screen, refer to the illustration above.

## Copyright

All other registered and unregistered trademarks are the property of their respective owners.



The terms HDMI and HDMI High-Definition Multimedia Interface, and the HDMI Logo are trademarks or registered trademarks of HDMI Licensing Administrator, Inc. in the United States and other countries.



Manufactured under license from Dolby Laboratories. Dolby, Dolby Audio, and the double-D symbol are trademarks of Dolby Laboratories.

Portions of this software are copyright © The FreeType Project ([www.freetype.org](http://www.freetype.org)).

The American Academy of Pediatrics discourages television viewing for children younger than two years of age.

Funai Corporation Inc. / P&F MEXICANA, S.A.de C.V. do not warrant access to the portal or to any of the services, content, software and advertising. Funai Corporation Inc. / P&F MEXICANA, S.A. de C.V. or third party content/service providers may, in their sole discretion, add or remove access to any specific services, content, software and advertising at any time. Although Funai Corporation Inc. / P&F MEXICANA, S.A. de C.V. will strive to provide a good selection of services, content or software, Funai Corporation Inc. / P&F MEXICANA, S.A. de C.V. do not warrant continued access to any specific services, and content or software.



# 2 Getting started

## Features

- **DTV / Analog TV / CATV**  
You can use your remote control to select channels which are broadcast in digital format and conventional analog format. Also, cable and satellite subscribers can access their TV channels.
- **Information display**  
You can display on the TV screen the title, contents (DTV only) and other information on the current program.
- **Auto scan**  
This unit automatically scans and memorizes channels available in your area, eliminating difficult setup procedures.
- **Child lock**  
This feature allows you to block children's access to inappropriate programs.
- **Closed caption decoder**  
Built-in closed caption decoder displays text for closed caption supported programs.
- **MTS / SAP tuner**  
Audio can be selected from the remote control.
- **Auto standby**  
If there is no input signal and no operation for 15 minutes, the unit will go into standby mode automatically.
- **Sleep timer**  
You can set the unit to go into standby mode after a specific amount of time.
- **Choices for on-screen language**  
Select your on-screen language: English, Spanish or French.
- **Stereo sound function**
- **PLL frequency synthesized tuning**  
Provides free and easy channel selection and lets you tune directly to any channel using the number and decimal point "\*" keys on the remote control.
- **Various adjustments for picture and sound**  
Customizes picture quality suitable for your room and sets your sound preference.
- **HDMI-CEC via HDMI link**  
HDMI-CEC allows your other HDMI link Devices to be controlled by the HDMI cable connected to your TV.
- **HDMI input**
- **HDMI-DVI input**  
If your video device has a DVI output jack, use an HDMI-DVI conversion cable to connect the unit.
- **Component video input**
- **AV input**  
Audio and video input from an external device.
- **USB terminal**  
The picture (JPEG) files stored on a USB memory stick can be played back on this unit.
- **Digital audio output**  
Digital audio (Supporting Dolby Digital) sent to home theaters and other digital audio systems.
- **Headphone audio output**  
Headphone 3.5mm stereo jack for personal listening.

## Included accessories

### Quick start guide



### Safety instruction / Limited warranty

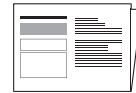

### Remote control and Batteries

(AAA, 1.5V x 2)

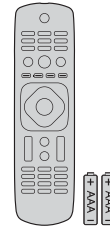

### TV base and screws



Screws packed with this unit.

Model	Quantity	Size
24PFL3603	2	ST3 x 0.551" (14 mm)

### Note(s)

- If you lose the screws, please purchase the above-mentioned phillips head screws at your local store.
- If you need to replace these accessories, please refer to the part name or No. with the illustrations and call our toll free customer support line found on the cover of this User manual.

#### When using a universal remote control to operate this unit.

- Make sure the component code on your universal remote control is set to our brand. Refer to the instruction book accompanying your remote control for more details.
- We do not guarantee 100% interoperability with all universal remote controls.

## Symbols used in this User manual

The following is the description for the symbols used in this User manual. Description refers to:

Digital TV operation

Cable / NTSC (Analog) TV operation

- If neither symbol appears, the operation is applicable to both.

## Installing the stands

Fasten the stand to the TV with 2 screws.

- While fastening the screws, hold the stand to prevent it from falling.
- Both stands should now be securely fastened.

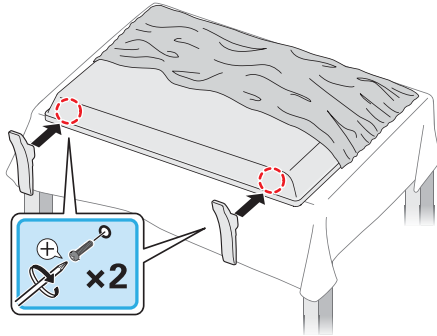

### Note(s)

- Make sure to use a table which can support the weight of this unit and is larger than this unit.
- Make sure the table is in a stable location.
- A phillips-head screwdriver is required to fasten the stands to the TV set.
- When attaching the stand, ensure that all screws are tightly fastened. If the stand is not properly attached, it could cause the unit to fall, resulting in injuries as well as damage to the unit.
- To remove the stand from this unit, unscrew the phillips-head screws by reversing the procedure. Be careful not to drop the stand when you remove it.

## Installing the remote control batteries

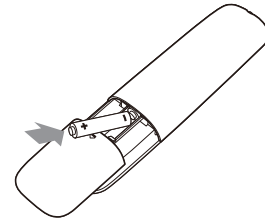

- 1 Slide the battery cover off the back of the remote control.
- 2 Insert the two included batteries (AAA, 1.5V). Be sure the + and – ends of the batteries line up with the markings inside the case.
- 3 Slide the cover back into position.

### Note(s)

- Remove the batteries if not using the remote control for an extended period of time.



## Remote control

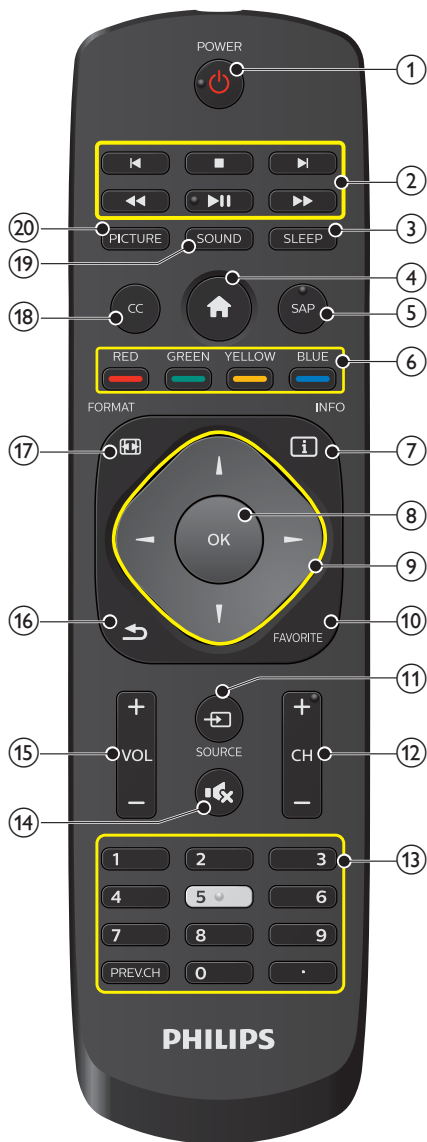

- ① **⏻ (POWER)**  
Turns the TV on from standby or off to standby.
- ② **HDMI-CEC keys**
  - ▶ || : Starts, pauses or resumes playback.
  - : Stops the disc playback.
  - ◀◀ / ▶▶ : Searches backward or forward through the disc.
  - ◀ / ▶ : Skips backward or forward chapters, titles or tracks on a disc.

### Note(s)

- You must set on in the **CEC** → p. 31 to operate the above functions.

- ③ **SLEEP**  
Sets sleep timer.
- ④ **🏠 (Home)**  
Displays the main menu.
- ⑤ **SAP**  
Selects audio mode (MONO / STEREO / SAP) / audio language.
- ⑥ **COLOR buttons**  
Use these keys according to the directions on-screen with HDMI-CEC function.
- ⑦ **ℹ INFO**  
Displays information about the current program.
- ⑧ **OK**  
Press to decide the command of setting when the menu is displayed.
- ⑨ **▲▼◀▶ (NAVIGATION buttons)**  
Moves the cursor, selects the on-screen menu items.
- ⑩ **FAVORITE**  
Switch to Favorite List menu.
- ⑪ **📺 SOURCE**  
Selects connected devices.
- ⑫ **CH + / -**  
Selects a channel.
- ⑬ **0 - 9 (NUMBER buttons)**  
Used to enter a channel / program number.
  - **(DOT)** : Use with **0-9** to select digital channels.  
For example, to enter 2.1, press

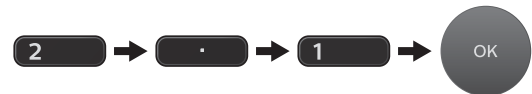

**PREV.CH** : Returns to the previously viewed channel.

- ⑭ **🔇 (MUTE)**  
Turns the sound on and off.
- ⑮ **VOL + / -**  
Adjusts the volume.
- ⑯ **↩ BACK**  
Returns to the previous menu operation.
- ⑰ **📺 FORMAT**  
Adjusts the picture size on the TV screen.
- ⑱ **CC**  
Displays the audio portion of programming as text superimposed over the video.
- ⑲ **SOUND**  
Adjust the sound mode.
- ⑳ **PICTURE**  
Adjust the picture mode.

## Control panel

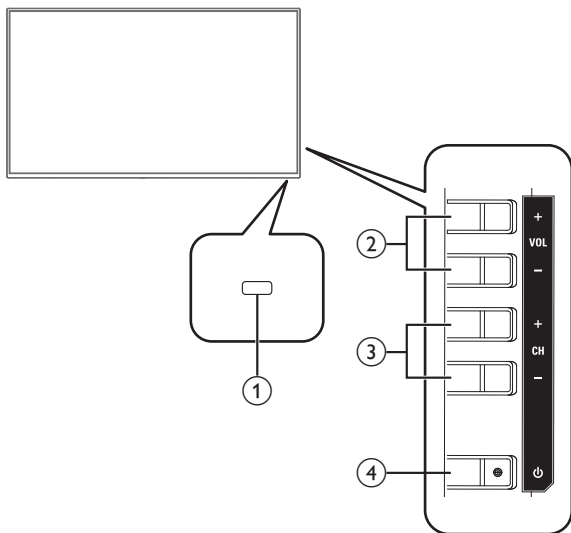

- ① **Remote control sensor**  
Receives IR signal from remote control.  
Do not block this remote control sensor window to allow proper operation.
- ② **VOL + / -**  
Adjusts the volume. In the menu screen, moves the cursor left (-) / right (+).  
**VOL +** : Volume up  
**VOL -** : Volume down
- ③ **CH + / -**  
Selects a channel. In the menu screen, moves the cursor up (+) / down (-).  
• When hold the CH + button about 3 sec., the main menu will display on the screen.  
• When hold the CH - button about 3 sec., the source select menu will display on the screen.
- ④ **⏻ (POWER / STANDBY)**  
Turns the TV on from standby or off to standby mode.

## Terminals

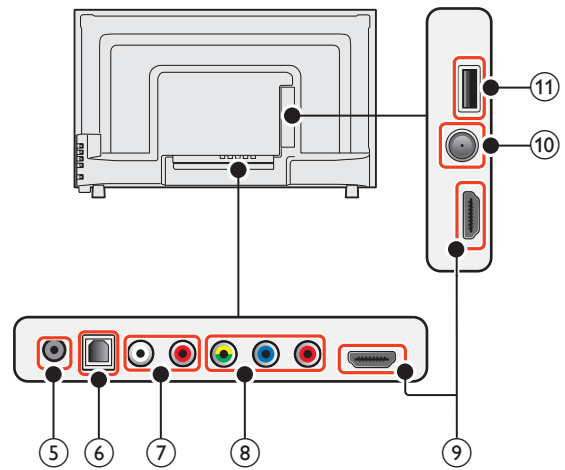

- ⑤ **Headphone audio output jack**  
Headphone 3.5mm stereo jack for personal listening.
- ⑥ **Digital audio output jack**  
Digital audio (S/PDIF) output to home theaters and other digital audio systems.
- ⑦ **Analog audio (L/R) input jacks**  
Connect analog audio signals from;  
• HDMI-DVI / Analog audio (L/R) jacks signal  
• Component video / Analog audio (L/R) jacks signal  
• Composite video / Analog audio (L/R) jacks signal  
• PC connection / Analog audio (L/R) jacks signal from stereo mini 3.5mm plug audio cable on PC.
- ⑧ **Component (Y/Pb/Pr) / Composite video (VIDEO) input jack(s) for VIDEO**  
Composite video input (VIDEO) jack is a shared jack with component video input (Y) jack.
- ⑨ **HDMI input jack(s)**  
Digital audio and video input from high-definition digital devices such as DVD / Blu-ray Disc™ players, cable or set-top boxes and PC's.
- ⑩ **75 ohm cable / Antenna connection**  
Signal input from an antenna, cable or set-top boxes.
- ⑪ **USB terminal**  
Data input from USB memory stick only.  
Do not connect any device to this terminal such as; digital camera, keyboard, mouse, etc.

## Connecting antenna or cable / satellite set-top box

Be sure your antenna or another device is connected properly before plugging in the AC power cord.

### If connecting to an antenna through an RF cable

Any DTV programs that are broadcast in your area can be received for free through an antenna connection.

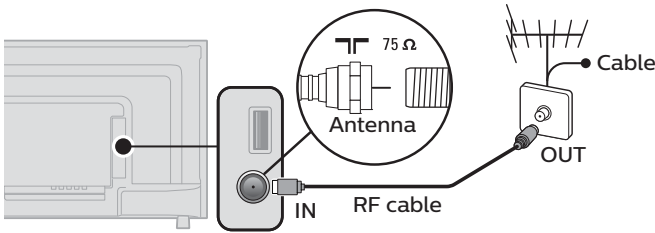

### If connecting cable / satellite set-top box using an RF cable

If the TV is connected to a cable / satellite set-top box via a coaxial connection, set the TV to channel 3/4 or the channel specified by the service provider.

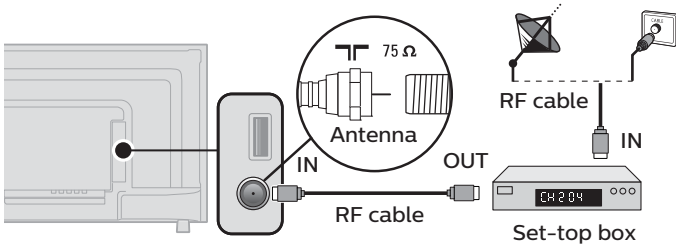

### If connecting cable / satellite set-top box using an HDMI cable

If the TV is connected to a cable / satellite set-top box via an HDMI cable, make sure you select the correct source by using **SOURCE**.

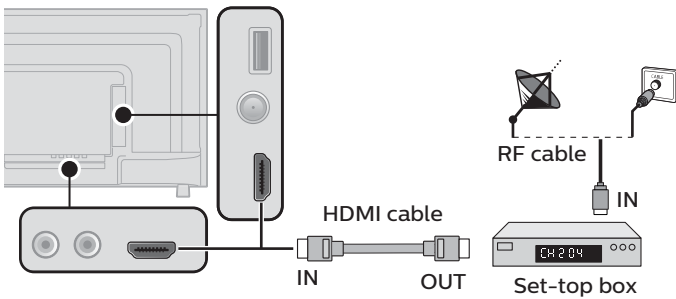

### If connecting cable / satellite set-top box using component video input

If the TV is connected to a cable / satellite set-top box via component video input, make sure you select the correct component video source by using **SOURCE**.

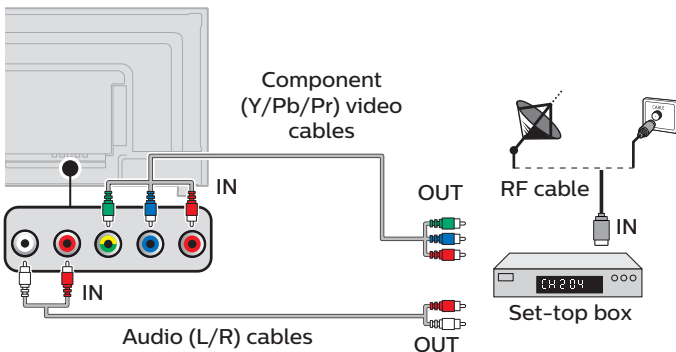

## Connecting a cable / satellite set-top box, Blu-ray Disc™ / DVD recorder via composite connectors and analog audio

Do not place your recorder too close to the screen because some recorders can be susceptible to signals from the TV.

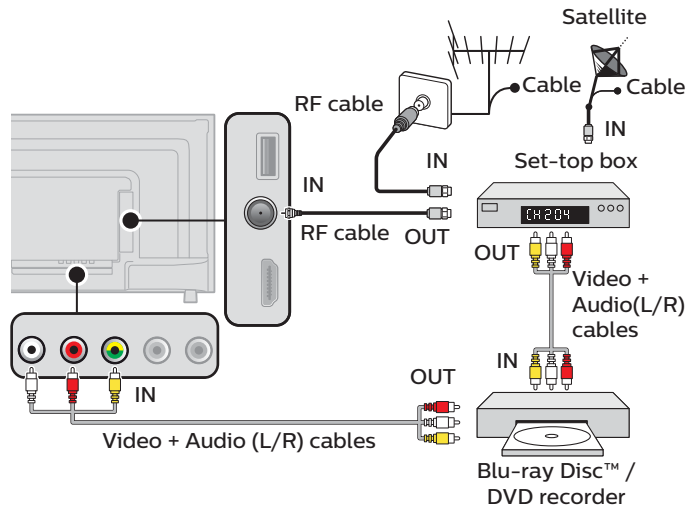

### Note(s)

- If you have any question about the DTV's antenna, visit [www.antennaweb.org](http://www.antennaweb.org) for further information.
- Depending on your antenna system, you may need different types of combiners (mixers) or separators (splitters) for HDTV signal. The minimum RF bandpass on these devices is 2,000MHz or 2GHz.
- For your safety and to avoid damage to this unit, please unplug the RF coaxial cable from the antenna input jack before moving the unit.
- If you did use an antenna to receive analog TV, it should also work for DTV reception. Outdoor or attic antennas will be more effective than a set-top box or inside antenna.
- To turn on your reception source easily between antenna and cable, install an antenna selector.
- If you are not receiving a signal from your cable service, contact the cable provider.
- Refer to the Quick start guide that shows the connections for the HDMI or component input mode.

## Plugging in the AC power cord

Make sure all the necessary connections are made before the AC power cord is plugged into an AC outlet.

### ! Caution(s)

- Connect the analog audio signal cables from the external device to the analog audio L/R input jacks.
- If you have an amplifier, connect the HDMI cable to the HDMI input via your amplifier.

### Note(s)

- Each time you plug in the AC power cord, no operations will be performed for several seconds. This is not a malfunction.

**No included cables are used with these connections:**

- Please purchase the necessary cables at your local store.

**Before you connect the AC power cord:**

Be sure other devices are connected properly before plugging in the AC power cord.

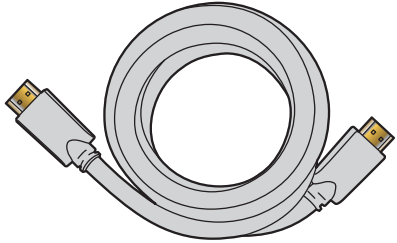
**Selecting your connection quality****HDMI - Highest quality**

Supports high-definition digital signals and gives highest picture and sound quality. Video and audio signals are combined in one cable. You must use HDMI for full high-definition video and to enable EasyLink.

**Note(s)**

- Philips HDMI supports HDCP (High-bandwidth Digital Contents Protection). HDCP is a form of digital rights management that protects high-definition content in Blu-ray Disc™ or DVDs.

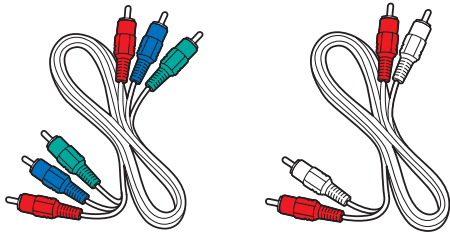
**Component (Y Pb Pr) - High quality**

Supports high-definition analog signals but gives lower picture quality than HDMI. Component (Y/Pb/Pr) video cables combine red / green / blue video cables with red / white audio (L/R) cables. Match the cable colors when you connect to the TV.

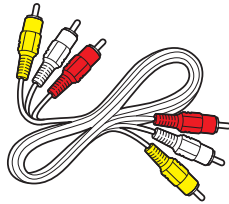
**Composite - Basic quality**

For analog connections. Composite video / Audio analog cable usually combine a yellow video cable with red / white audio (L/R) cables. With this unit, yellow cable must be connected to Y (green) jack on the component video input jacks.

**Connecting your devices****HDMI digital connection**

HDMI connection offers the highest picture quality. HDMI (High-Definition Multimedia Interface) transports high-definition digital video and multi-channel digital audio through a single cable.

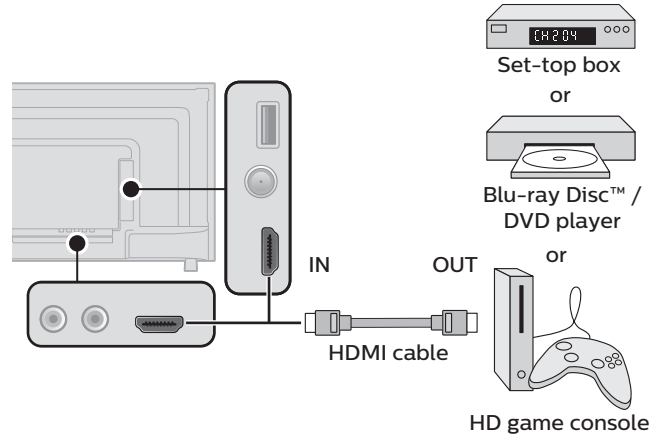
**HDMI-DVI connection**

This unit can be connected to a device that has a DVI terminal. Use an HDMI-DVI conversion cable for this connection and it requires audio cable for analog audio signal as well.

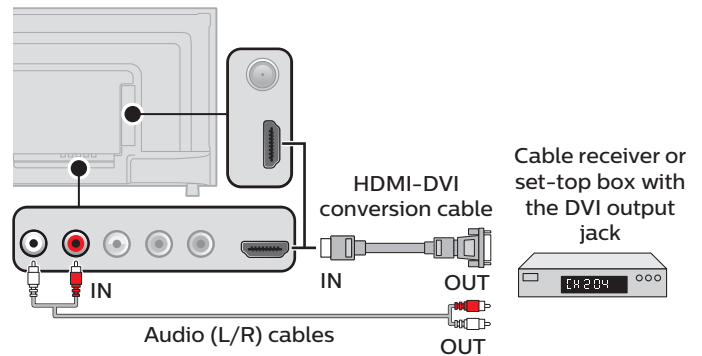
**Note(s)**

- Use an HDMI cable with the HDMI logo (a certified HDMI cable). High speed HDMI cable is recommended for the better compatibility.

**For HDMI connection**

- The unit accepts 480i / 480p / 720p / 1080i, 1080p 24/30/60Hz of video signals, 32kHz / 44.1kHz and 48kHz of audio signals.
- If you are using a source capable of greater resolution such as 4K or 4K HDR, please lower the output resolution on the device to 1080p@60Hz.
- This unit accepts a 5.1 channel audio signal (Dolby Digital) and 2 channel audio signal (LPCM).
- This unit accepts only signals in compliance with EIA861.

**For HDMI-DVI connection**

- The unit accepts 480i, 480p, 720p, 1080i and 1080p video signals.
- HDMI-DVI connection requires separate audio connections as well and the audio signals are output as analog (L/R) audio.
- DVI does not display 480i image which is not in compliance with EIA/CEA-861/861B.

## Component analog video connection

Component analog video connection offers better picture quality for video devices connected to the unit.

If you connect to the unit's component video (Y/Pb/Pr) input jacks, connect analog audio cables to the analog audio (L/R) input jacks.

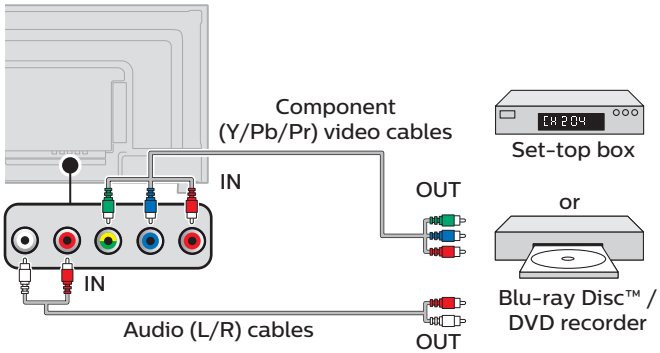

### Note(s)

- The unit accepts 480i / 480p / 720p and 1080i of video signals for this connection.

## Digital audio output connection

If you connect this unit to an external digital audio device, you can enjoy multi-channel audio like 5.1ch digital broadcasting sound.

Use a digital audio optical cable to connect the unit to external digital audio devices.

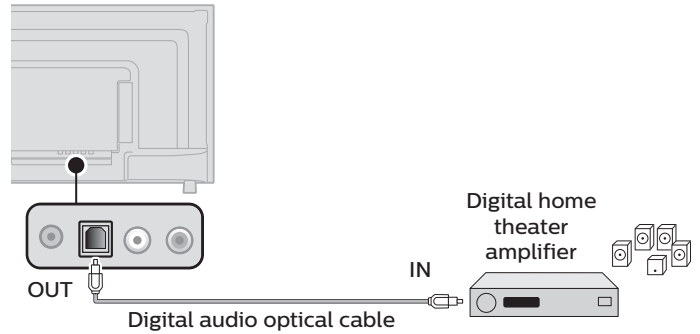

## Composite analog video connection

Composite analog video connection offers standard picture quality for video devices connected to the unit.

If you connect to the unit's component / composite video (Y/VIDEO) input jack (green), connect audio cables to the audio (L/R) input jacks. When the audio is monaural, then only connect to the audio L input jack.

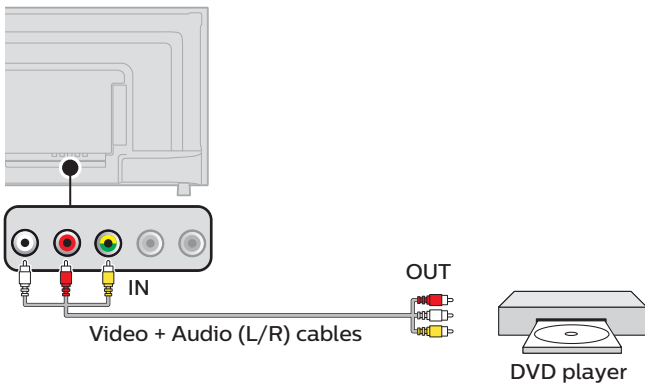

### Note(s)

- With this unit, yellow cable must be connected to Y (green) jack on the component video input jacks.
- Whenever you connect to the composite video input jack (Y/VIDEO), you must disconnect the component video input jacks (Pb and Pr). If you leave those jacks connected, it may cause an unstable picture.

## PC connection

### HDMI connection

This unit can be connected to your PC that has an HDMI terminal. Use an HDMI cable for this digital connection.

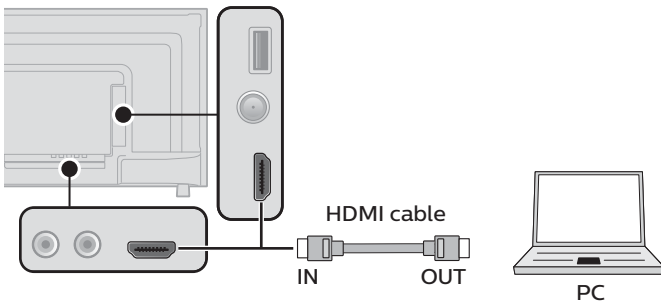

### HDMI-DVI connection

This unit can be connected to your PC that has a DVI terminal. Use an HDMI-DVI conversion cable for this video digital connection and it requires stereo mini 3.5mm plug audio cable for analog audio signal as well.

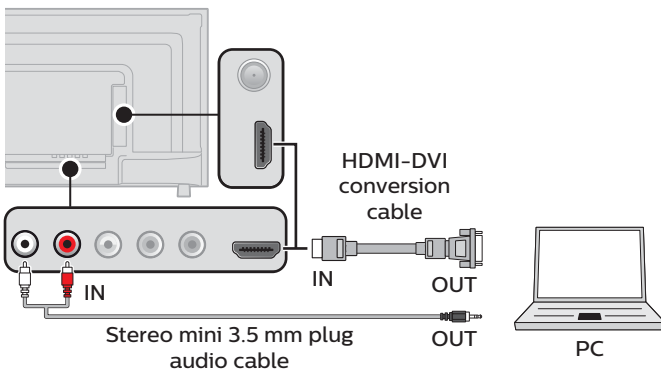

The following PC-input video signals can be displayed:

Format	Resolution	Refresh rate
VGA	640 x 480	60Hz
SVGA	800 x 600	
XGA	1,024 x 768	
WXGA	1,280 x 720	
	1,366 x 768	
FHD	1,920 x 1,080	

Other formats or non-standard signals will not be displayed correctly.

### Note(s)

- Please purchase a HDMI-DVI conversion cable that has a ferrite core.
- The following operations may reduce noise.
  - Attach a ferrite core to the AC power cord of your PC.
  - Unplug the AC power cord and use the built-in battery of your portable / laptop PC.
- Use an HDMI cable with the HDMI logo (a certified HDMI cable). High speed HDMI cable is recommended for the better compatibility.
- The unit accepts 480i, 480p, 720p, 1080i and 1080p video signals.
- HDMI-DVI connection requires separate audio connections as well and the audio signals are output as analog (L/R) audio.
- DVI does not display 480i image which is not in compliance with EIA/CEA-861/861B.

## USB memory stick

This unit offers easy playback of picture (JPEG) files.

Insert the USB memory stick into the USB terminal shown below.

**MULTIMEDIA** → p. 32

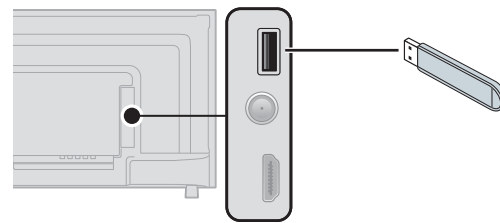

Picture (JPEG / Progressive JPEG)		
JPEG	Upper limit	4000x4000 pixels
Progressive JPEG	Upper limit	1024x768 pixels

### Note(s)

- The unit recognizes only a USB memory stick.
- Do not use a USB hub or an extension cable to connect an external hard disk drive to the unit. (Not supported.)
- Always insert a USB memory stick directly to this unit.
- A USB memory stick is not included with this unit.
- We do not guarantee that all USB memory sticks can be supported by this unit.
- Be sure to keep a backup copy of the original files on your USB device before you play them back on this unit. We have no responsibilities for damage or loss of your USB stored data.
- To protect your USB memory stick files from being erased place the write protect sliding tab in the protect position (if available).
- When you are ready to remove a USB memory stick, set the unit to go into standby mode to avoid any damage to your data and the unit.
- A USB memory stick that requires its own driver or the device with a special system such as fingerprint recognition are not supported.
- This unit is not allowed to use the USB memory stick which requires an external power supply (500mA or more).



*These operations are accessible by remote control.  
Some may also be accessible by the main unit's control panel.*

### After an setup wizard is completed...



























- If you want to scan the channels automatically again.  
**Auto Scan** ➔ p. 23
- You can add the desired cable and analog channels not memorized by auto scan.  
**Favorite** ➔ p. 24
- If you want to change to another language.  
**Menu Language** ➔ p. 28

## Setup wizard

This section will guide you through the unit's Setup wizard which includes selecting a language for your On-screen menu and auto scan, which automatically scans and memorizes viewable channels.

### Before you begin:

Make sure the unit is connected to an antenna or cable.

- 1 After making all the necessary connections, press  to turn on the unit.
  - It may take a few moments to turn on the unit for the first time.
  - **Setup Wizard** menu appears automatically after the unit is turned on.
- 2 Use   to select **Menu Language** and use   to select **English**, **Spanish** or **French**.
- 3 Use   to select **Go to next step** and press **OK**.
- 4 Use   to select **Time Zone** and use   to select **Pacific / Alaska / Hawaii / Atlantic / Eastern / Central / Mountain**.
- 5 Use   to select **Daylight Saving Time** and use   to select **On / Off**.
- 6 Use   to select **Time Format** and use   to select **24-hour / 12-hour**.
- 7 Use   to select **Go to next step** and press **OK**.
- 8 Use   to select **Air/Cable** and use   to select **Air / Cable**.
  - When **Air** is selected, the TV detects antenna signals. It searches for DTV and analog TV channels available in your area.
  - When **Cable** is selected, the TV detects signals supplied by cable. It searches for DTV, analog TV and cable channels available in your area.
- 9 Use   to select **Go to next step** and press **OK**.
  - Auto Tuning will begin.

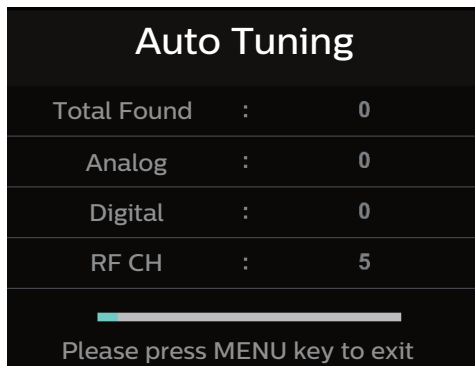

## 3 Use your TV

### Switching on your TV and putting it in standby mode

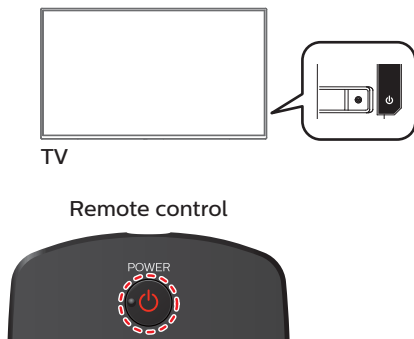

To turn the TV on from standby or off to standby

- Press  on the unit or the remote control.

#### Note(s)

- Energy consumption contributes to air and water pollution. When the AC power cord is plugged in, your TV consumes energy with a very low standby power consumption.

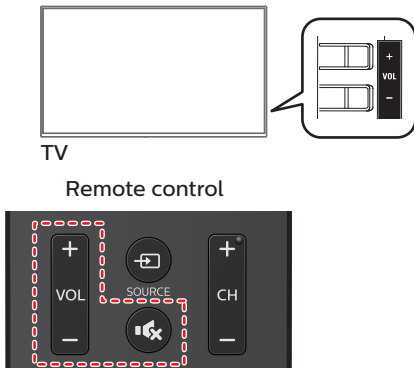

### Adjusting volume



To decrease or increase volume

- Press **VOL + / -** on the TV or the remote control.  
**VOL +** : Volume up  
**VOL -** : Volume down

To mute or unmute sound

- Press  on the remote control to mute the sound.
- Press  again or **VOL +** to recover the original sound.

### Switching channels

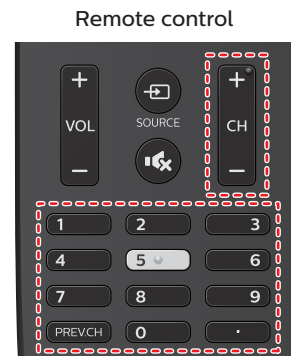
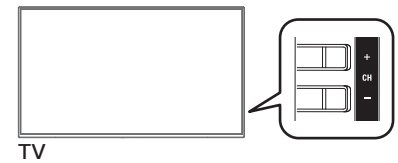

To select channels by using CH + / -

- Press **CH + / -** on the TV or the remote control.

To select channels by using the NUMBER keys

#### Digital TV operation

- For digital channels, press a number followed by a dot “.” and the corresponding sub channel number.  
 - When selecting digital channel 11.1  
 Be sure to press • before entering the subchannel number.



#### Cable / NTSC (Analog) TV operation

- When selecting cable or analog channel 11



Press **PREV.CH** to return to the previously viewed channel.

#### Note(s)

- To select the non-memorized channels, use **the NUMBER keys**.
- **NO SIGNAL** will appear on the TV screen after the subchannel broadcast is over.
- **Audio Only** message will appear on the TV screen, when you receive only a sound signal.

## Watching channels from an external device

Switching each input mode can easily switch with the remote control between TV and external devices when they are connected to the unit.

- 1 Turn on the set-top box or the connected device.

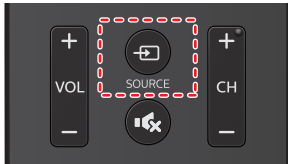

- 1 Press **SOURCE** and use **▲▼** to select the set-top box or the connected device and wait a few seconds till the picture appears.

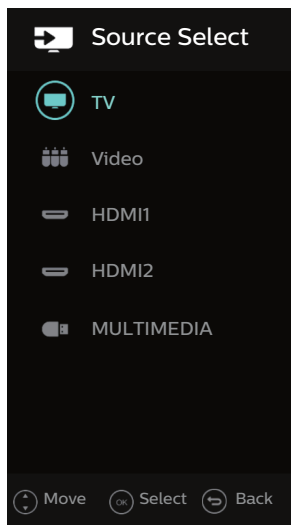

- 2 Use the remote control of the set-top box or the connected device to select channels.

## Sleep timer

Sleep timer can set the unit to go into standby mode after an incremental period of time.



Press **SLEEP** repeatedly to change the amount of time (increases the time by 5 minutes up to 240 minutes).

5 min

Press **SLEEP** once to call up the display for checking the remaining time.

- To cancel sleep timer, press **SLEEP** Repeatedly until **Off** is displayed.

## Switching audio mode



### Digital TV operation

- 1 Press **SAP** to display the currently selected language.
- 2 Press **SAP** repeatedly to cycle through the available audio languages.

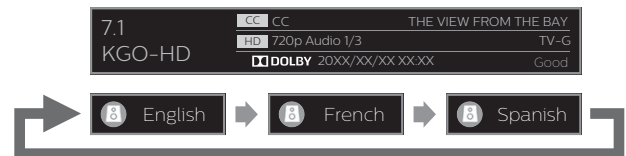

### Note(s)

- Available languages differ depending on the broadcast.
- **Other** is displayed when the audio language cannot be acquired or the acquired languages are other than English, French or Spanish.

### Cable / NTSC (Analog) TV operation

- 1 Press **SAP** to display the currently selected audio mode.
- 2 While receiving an MTS broadcast, press **SAP** repeatedly to cycle through the available audio channels.  
e.g.) When all audio modes are available



- Stereo** : Outputs stereo audio  
**Mono** : Outputs mono audio  
**SAP** : Outputs a second audio program

## Create a list of favorite channels

You can create lists of your preferred TV channels so that you can find those channels easily.

Add channels to create a favorite list, refer to **Favorite** → p. 24.

## Display the list of favorite channels

After a favorite channel is added, press **FAVORITE**, the favorite channels will display on the list.

You can use ▲▼ to change the channel at the favorite list menu.



## Changing picture format

Display modes can be selected when your TV receives a 16:9 or 4:3 video signal.

Two types of display modes can be selected for a PC input signal.

Press **FORMAT** repeatedly to switch the TV aspect ratio.



<b>Normal</b>	Automatically adjust aspect ratio based on TV size and TV program.
<b>Wide</b>	Use to watch wide screen (16:9) content.
<b>Zoom</b>	Expands image to fill screen. Top and bottom maybe cut off.
<b>Cinema</b>	Stretches image at edges but keeps a clear image in the center.
<b>Full (DVI)</b>	Displays a picture that is stretched out of proportion to fill the screen.
<b>Point to point (DVI)</b>	Displays a picture in its original size.

### For 16:9 analog video signal

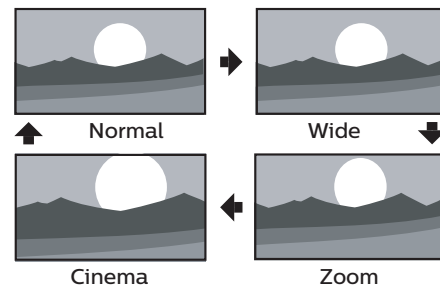

### For 4:3 analog video signal

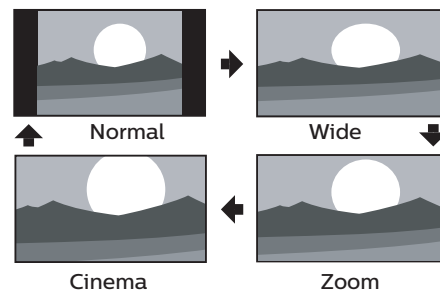

### For HDMI input signal

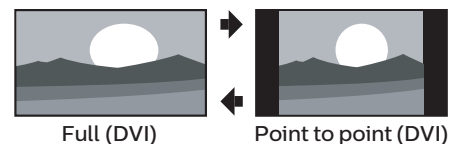

- This unit can also be connected to your PC that has a DVI terminal. Use an HDMI-DVI conversion cable for this video connection and it requires a stereo mini 3.5mm plug audio cable for analog audio signal as well.
- Refer to 16:9 video signal on this page if the PC has an HDMI output.

## TV screen information

You can display the currently selected channel or other information such as the aspect ratio on the TV screen.

In the digital mode, the detailed broadcasting information for the current off the air channel, such as program title, are displayed.

- 1 Press **INFO**.

### Digital TV operation

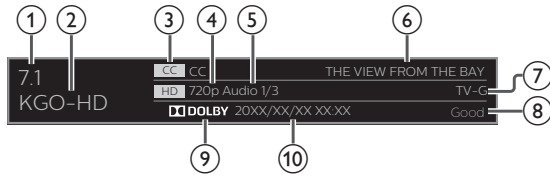

- 1 Channel number  
Switching channels → p. 16
- 2 Program title
- 3 CC (not available if Closed caption is set to Off)  
Closed Caption → p. 28
- 4 Signal resolution
- 5 Audio information  
Switching audio mode → p. 17
- 6 Broadcast station
- 7 Lock rating  
Child and ratings lock → p. 25
- 8 Signal quality
- 9 Dolby
- 10 Clock

### Cable / NTSC (Analog) TV operation

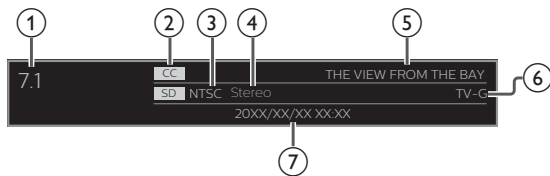

- 1 Channel number  
Switching channels → p. 16
- 2 CC (not available if Closed caption is set to Off)  
Closed Caption → p. 28
- 3 Signal resolution
- 4 Audio mode  
Switching audio mode → p. 17
- 5 Broadcast station
- 6 Lock rating  
Child and ratings lock → p. 25
- 7 Clock

- 2 Press **INFO** to hide the information.

#### Note(s)

- While the program guide is displayed, the closed caption function is interrupted.
- The information display will automatically disappear in 5 seconds.

## 4 Getting the most from your TV

This section describes the overview of the main menu displayed when you press **HOME**.

The main menu consists of the function setting items below.

### Displaying the main menu

- 1 Press **HOME** to display the main menu.

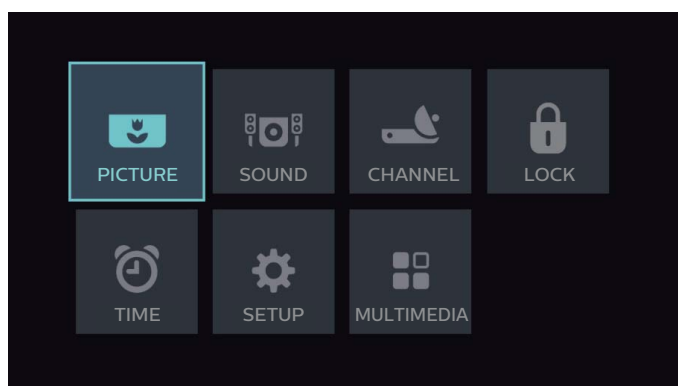

- 2 Use **▲▼◀▶** to select the desired menu and an item, then press **OK**.

#### PICTURE

➡ p. 21

Adjusting the picture mode or customize the picture quality as your preference.

#### SOUND

➡ p. 22

Adjusting the sound mode, equalizer and some other sound functions.

#### CHANNEL

➡ p. 23

Scanning the channels available in your area and see what the antenna signal levels are.

#### LOCK

➡ p. 25

Setting the parental guide and some other useful functions.

#### TIME

➡ p. 27

Setting the sleep timer, time zone and some other useful functions.

#### SETUP

➡ p. 28

Setting the on-screen language, closed caption and some other useful functions.

#### MULTIMEDIA

➡ p. 32

You can view picture (JPEG) files stored on a USB memory stick.

- 3 When the setting is completed, press **HOME** or **BACK** to exit.



# PICTURE

1 Press **HOME** and use **▲▼◀▶** to select **PICTURE**, then press **OK**.

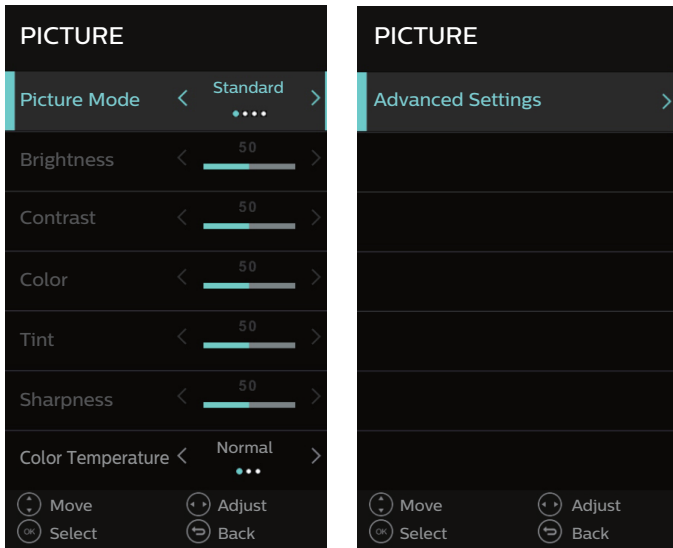

2 Use **▲▼◀▶** to select the item you want to adjust, then press **OK**.

Picture Mode	To select the desired setting, then press <b>OK</b> . ( <b>Standard</b> , <b>Dynamic</b> , <b>Soft</b> or <b>User</b> ) The brightness, contrast, color, tint and sharpness are only available in <b>User</b> mode.	
	◀ Cursor	Cursor ▶
Brightness	To decrease brightness	To increase brightness
Contrast	To decrease contrast	To increase contrast
Color	To decrease color intensity	To increase color intensity
Tint	To add red	To add green
Sharpness	To soften	To sharpen
Color Temperature	To set the picture color temperature to <b>Normal</b> , <b>Warm</b> and <b>Cool</b> . Increase or reduce warm color of the picture personally (red), and the cool color personally (blue).	
Advanced Settings	To select the desired setting, then press <b>OK</b> . ( <b>Format</b> , <b>Noise Reduction</b> , <b>Dynamic Contrast</b> , <b>HDMI Mode</b> and <b>120 PMR</b> )	

• You can set a particular picture quality using **Advanced Settings**.

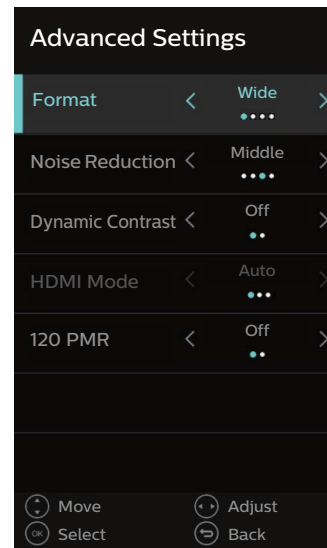

Format	Changing picture format ⇒ p. 18	
Noise Reduction	To select the desired setting, then press <b>OK</b> . ( <b>Off</b> , <b>Low</b> , <b>Middle</b> or <b>High</b> )	
Dynamic Contrast	Off	To set <b>Dynamic Contrast</b> to <b>Off</b>
	On	To enhance contrast in an image automatically
HDMI Mode	Auto	Automatic recognize the original input signal
	Video	Set the output image to video mode
	Graphic	Set the output image to graphic mode
120 PMR	Off	To set <b>120 PMR</b> to <b>Off</b>
	On	To make the video appear smoother

## SOUND

1 Press **Home** and use **▲▼◀▶** to select **SOUND**, then press **OK**.

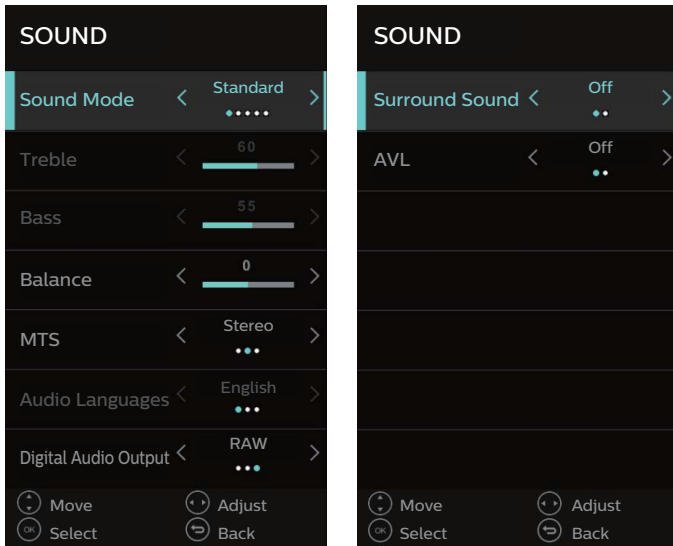

2 Use **▲▼◀▶** to select the item you want to adjust, then press **OK**.

<b>Sound Mode</b>	To select the desired setting, then press <b>OK</b> . ( <b>Standard</b> , <b>User</b> , <b>Movie</b> , <b>Sports</b> or <b>Music</b> ) The bass, treble and balance are only available in <b>User</b> mode.
	<b>◀ Cursor</b> <b>Cursor ▶</b>
<b>Treble</b>	Adjust the treble effect. Increases or decreases high-pitched sounds.
<b>Bass</b>	Adjust the bass effect. Increases or decreases lower-pitched sounds.
<b>Balance</b>	Adjust the balance between left and right speakers to adapt to your listening position.

You can set the output mode as a default for the sound mode (Analog TV only).

This setting is not interlocked when you change the output mode by pressing **SAP**. Refer to **Switching audio mode** ➔ p. 17.

<b>MTS</b>	<b>Mono</b>	To output mono audio
	<b>Stereo</b>	To output stereo audio
	<b>SAP</b>	To output second audio program

Select the language supported by the chosen digital channel. It is available only in TV source.

<b>Audio Languages</b>	To set your preferred language in the audio streaming ( <b>English</b> , <b>Spanish</b> or <b>French</b> ).
------------------------	---

You can select audio output through a digital audio output connector.

<b>Digital Audio Output</b>	<b>Off</b>	To set <b>Digital Audio Output</b> to <b>Off</b>
	<b>PCM</b>	To output PCM format
	<b>RAW</b>	Original image coded date

Select the speaker sound effect to be surround or not.

<b>Surround Sound</b>	<b>Off</b>	To set <b>Surround Sound</b> to <b>Off</b>
	<b>On</b>	To set <b>Surround Sound</b> to <b>On</b>

This function keeps a constant loudness level between the TV commercials and the programs.

<b>AVL</b>	<b>Off</b>	To remove the <b>AVL</b>
	<b>On</b>	To reduce volume differences between the TV commercials and the programs

## CHANNEL

### Before you begin:

Make sure the unit is connected to antenna or cable.

- 1 Press **HOME** and use **▲▼◀▶** to select **CHANNEL**, then press **OK**.

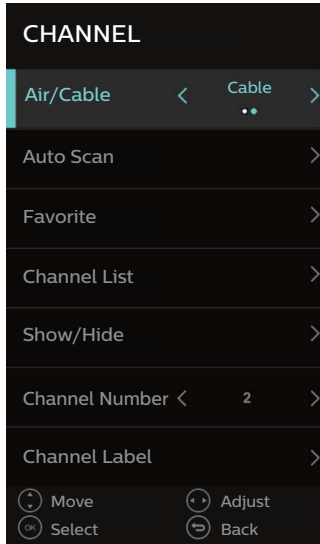

- 2 Adjust the following items.

## Air/Cable

Select signal type.

- 1 Use **▲▼** to select **Air/Cable**, then use **◀▶** to select the item.

Air	When <b>Air</b> is selected, the TV detects any Off-the-Air antenna signals. It searches for ATSC (Digital) and NTSC (Analog) channels available in your area.
Cable	When <b>Cable</b> is selected, the TV detects signals supplied by cable. It searches for ATSC (Digital), NTSC (Analog) and Cable channels available in your area.

## Auto Scan

Be sure the RF cable is correctly connected to this unit and you are registered with your cable TV provider when you install cable channels.

- 1 Use **▲▼** to select **Auto Scan**, then press **OK**.

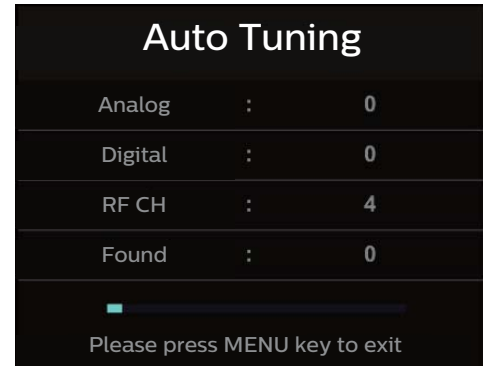

- When the scanning and memorizing of available channels is completed, the lowest memorized channel will be displayed.

### Note(s)

- After setting **Auto Scan**, using **CH + / -** skips unavailable channels automatically.
- If you are not receiving a signal from your cable service, contact the cable provider.
- If you press **POWER** or **HOME** during auto scan, the setup of TV channels will be cancelled.
- Even if **Auto Scan** is completed, the channel setting will be lost if the AC power cord is unplugged before the unit goes into standby mode by pressing **POWER**.
- The PIN code will be required once you set a PIN code in the **Child and ratings lock** → p. 25
- If you want to change your PIN code, follow the instruction for **Change Password** → p. 25

## Favorite

Add some channels to the Favorite List.

- 1 Use ▲▼ to select **Favorite**, then press **OK**.
- 2 Use ▲▼ to select the channel you want to add, then press **OK**.
  - If you need to cancel the favorite setting, select the favorite channel, and press **OK** to cancel favorite setting.

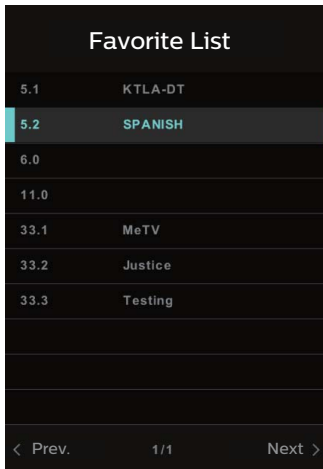

## Channel List

Display the **Channel List** menu.

- 1 Use ▲▼ to select **Channel List**, then press **OK**.
- 2 Use ▲▼ to select the channel you want to switch, then press **OK**.



## Show/Hide

Show or hide the channels in your program list.

- 1 Use ▲▼ to select **Show/Hide**, then press **OK**.
- 2 Use ▲▼ to select the channel you want to show / hide, then press **OK**.
  - If you need to cancel the **Show/Hide** setting, select the show / hide channel, and press **OK** to cancel the setting.
  - The hidid channel can be skipped when selecting the channels using **CH + / -**, **PREV.CH** keys.
  - The hidid channels can still be selected with the **NUMBER** keys.

## Channel Number

Show the channel number.

- 1 Use ▲▼ to select **Channel Number**.
- 2 Use ◀▶ to select **5.1 / 5.2 / 6.0 / 11.0 / 33.1 / 33.2 / 33.3**.

## Channel Label

Create labels for channels, up to 7 characters.

- 1 Use ▲▼ to select **Channel Label**, then press **OK**.
- 2 Use ▲▼◀▶ to adjust.

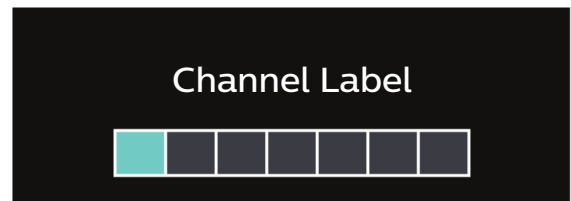

## LOCK

- 1 Press **Home** and use **▲▼◀▶** to select **LOCK**, then press **OK**.
- 2 Use **the NUMBER buttons** to enter the 4-digit numbers for your PIN code.
  - When you have not set up your PIN code, enter **0, 0, 0, 0**.
  - When the PIN code is correct, **LOCK** menu is displayed.

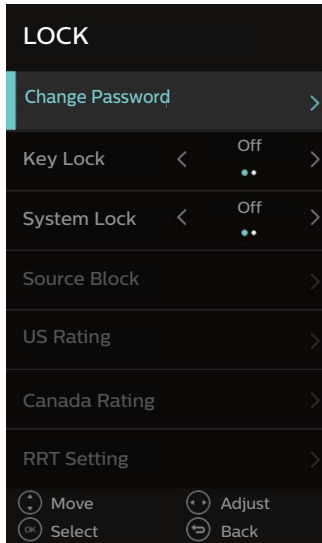

- 3 Adjust the following items.

## Change Password

Although the default PIN code (0000) is supplied with the unit, you can set your own PIN code.

- 1 Use **▲▼** to select **Change Password**, then press **OK**.
- 2 Press **the NUMBER buttons** to enter the new 4-digit PIN code.
  - Enter PIN code again in **Confirm Password** entry field.

### Note(s)

- Make sure to enter a PIN code and the confirm PIN code must be exactly the same. If they are different, the space is cleared to reenter the new PIN code.
- If you forget the PIN code, you can enter the "071 1" universal password to enter the **LOCK** menu.

## Key Lock

- 1 Use **▲▼** to select **Key Lock**, then use **◀▶** to select the item.

Off	Unlock the panel buttons on the TV.
On	Lock the panel buttons on the TV.

## System Lock

Lock or unlock the buttons on the TV.

- 1 Use **▲▼** to select **System Lock**, then use **◀▶** to select the item.

Off	Unlock the system.
On	Lock the system.

## Child and ratings lock

### Source Block

Particular channels or external input modes can be invisible in this function.

- 1 Use **▲▼** to select **Source Block**, then press **OK**.
- 2 Use **▲▼** to select the particular channels or external input, then press **OK** repeatedly to switch between block and unblock.

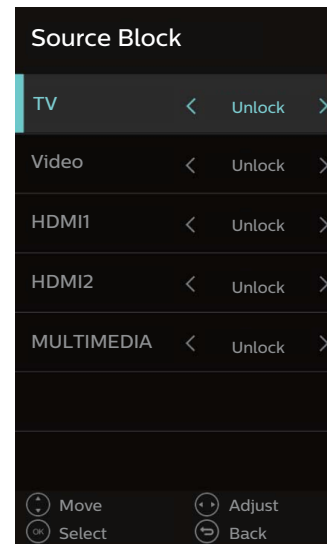

## Setting US rating

US movie ratings lock is the rating system created by MPAA. US TV ratings lock has controlled access to individual programs based on their age and content rating.

- 1 Use ▲▼ to select **US Rating**, then press **OK**.
- 2 For US TV ratings, press **OK** to enter the sub ratings to lock or unlock the programs.
  - □ indicates that the rating is not locked (Viewable).
  - 🔒 indicates that the rating is locked (Blocked).
- 3 For MPAA ratings, use ◀▶ to select the desired rating to switch between lock and unlock.

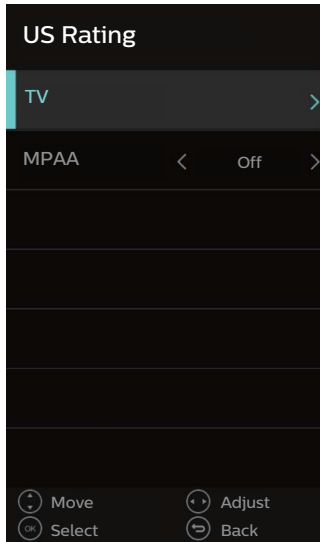

Movie ratings	TV ratings	Description
Off	–	No rating
–	<b>All</b>	All ratings locked including no rating
–	<b>TV-Y</b>	Appropriate for all children
–	<b>TV-Y7</b>	Appropriate for all children 7 and older
<b>G</b>	<b>TV-G</b>	General audience
<b>PG</b>	<b>TV-PG</b>	Parental guidance suggested
<b>PG-13</b>	–	Unsuitable for children under 13
–	<b>TV-14</b>	Unsuitable for children under 14
<b>R</b>	–	Restricted under 17 requires accompanying parent or adult guardian
<b>NC-17</b>	–	No one under 17 admitted
<b>X</b>	<b>TV-MA</b>	Mature audience only

### To set the sub ratings (displayed in the right column)

As for **TV-Y7**, **TV-PG**, **TV-14** or **TV-MA**, you can further set the sub ratings to block specific elements within programs. To set the sub ratings, follow the step below.

Use ▲▼◀▶ to select the desired rating, then press **OK** repeatedly to switch between 🔒 and □.

- □ indicates that the rating is not locked (Viewable).
- 🔒 indicates that the rating is locked (Blocked).

US TV ratings	Sub rating
<b>TV-Y7</b>	(FV)Fantasy Violence
<b>TV-PG</b>	(D)Dialog (L)Language (S)Sex (V)Violence
<b>TV-14</b>	(L)Language (S)Sex (V)Violence
<b>TV-MA</b>	(L)Language (S)Sex (V)Violence

### Note(s)

- Blocked sub rating will appear beside the main rating category in **US Rating** menu.
- Changing the category to 🔒 or □ automatically changes all its sub ratings to the 🔒 or □

## Canadian English or Canadian French ratings

You can select the rating for Canadian English or Canadian French broadcasting.

- 1 Use ▲▼ to select **Canada Rating**, then press **OK**.
- 2 Use ▲▼ to select the desired rating, then use ◀▶ to select the desired rating to switch between lock and unlock.
  - □ indicates that the rating is not locked (Viewable).
  - 🔒 indicates that the rating is locked (Blocked).

Canadian English rating	Canadian French rating	Description
<b>Off</b>		No rating
<b>C</b>	–	For all children
<b>C8+</b>	–	For all children 8 and older
<b>G</b>		General audience
–	<b>8ans+</b>	Unsuitable for ages under 8
<b>PG</b>	–	Parental guidance suggested
–	<b>13ans+</b>	Unsuitable for ages under 13
<b>14+</b>	–	Unsuitable for ages under 14
–	<b>16ans+</b>	Unsuitable for ages under 16
<b>18+</b>	<b>18ans+</b>	Adult audience only

## RRT Setting

Display an advance V-Chip rating table for digital channels. The item is available only When current stream has downloadable rating data.

- 1 Use ▲▼ to select **RRT Setting**, then press **OK**.



## TIME

- 1 Press **HOME** and use **▲▼◀▶** to select **TIME**, then press **OK**.

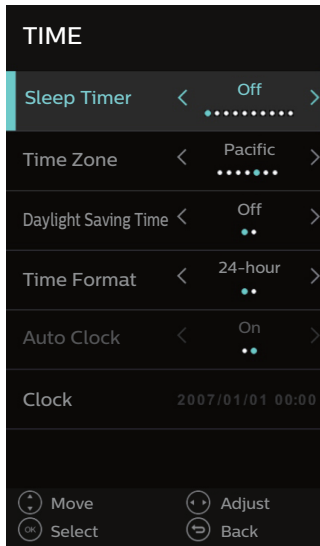

- 2 Adjust the following items.

### Sleep Timer

Set a timer for the TV to turn off automatically.

- 1 Use **▲▼** to select **Sleep Timer**.
- 2 Use **◀▶** to select **Off** or **5 Min** to **240 Min**.

### Time Zone

Select your time zone.

- 1 Use **▲▼** to select **Time Zone**.
- 2 Use **◀▶** to select **Pacific / Alaska / Hawaii / Atlantic / Eastern / Central / Mountain**.

### Daylight Saving Time

Set the daylight saving time for your area.

- 1 Use **▲▼** to select **Daylight Saving Time**, then use **◀▶** to select the item.

Off	To set <b>Daylight Saving Time</b> to <b>Off</b>
On	To set <b>Daylight Saving Time</b> to <b>On</b>

### Time Format

Select your time format.

- 1 Use **▲▼** to select **Time Format**.
- 2 Use **◀▶** to select **12-hour** or **24-hour**.

### Auto Clock

Use to synchronize the display automatically.

- 1 Use **▲▼** to select **Auto Clock**, then use **◀▶** to select the item.

Off	To set <b>Auto Clock</b> to <b>Off</b>
On	To set <b>Auto Clock</b> to <b>On</b>

### Clock

It is available only when the **Auto Clock** sets to be **Off**.

- 1 Use **▲▼** to select **Clock**.
  - When the **Auto Clock** setting is **Off**, this item can be selected.
- 2 Press **OK**.
  - Then you can set the clock you want.

## SETUP

- 1 Press **Home** and use **▲▼◀▶** to select **SETUP**, then press **OK**.

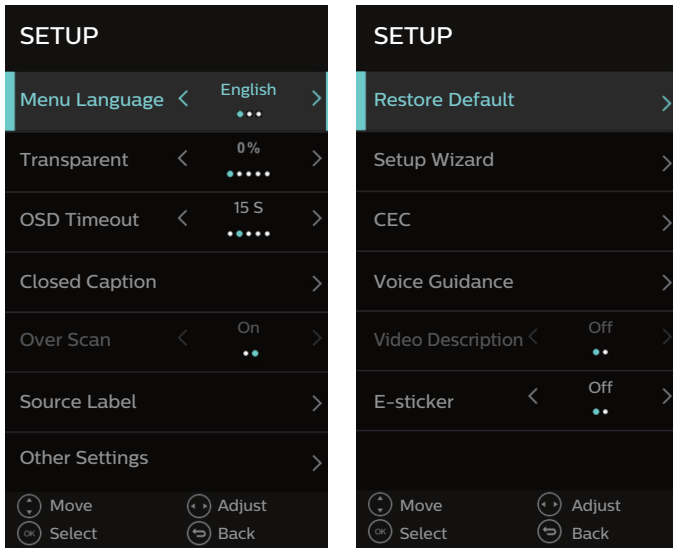

- 2 Adjust the following items.

### Menu Language

- 1 Use **▲▼** to select **Menu Language**.
- 2 Use **◀▶** to select **English**, **Spanish** or **French**, then press **OK**.

#### Note(s)

- If you need the English menu instead of the Spanish or French menu's, press **Home**.  
Use **▲▼** to select **Idioma** or **Languae**.  
Use **◀▶** to select **English**.  
Press **Home** to exit the main menu.

### Transparent

Adjust the transparency of the OSD (on screen display) menu.

- 1 Use **▲▼** to select **Transparent**.
- 2 Use **◀▶** to select **0%** / **25%** / **50%** / **75%** / **100%**.

### OSD Timeout

Adjust the duration of the OSD (on screen display) menu.

- 1 Use **▲▼** to select **OSD Timeout**.
- 2 Use **◀▶** to select **5 S** / **15 S** / **30 S** / **45 S** / **60 S**.

## Closed Caption

Closed captions displays the audio portion of the program as superimposed text over the video.

- 1 Use **▲▼** to select **Closed Caption**, then press **OK**.

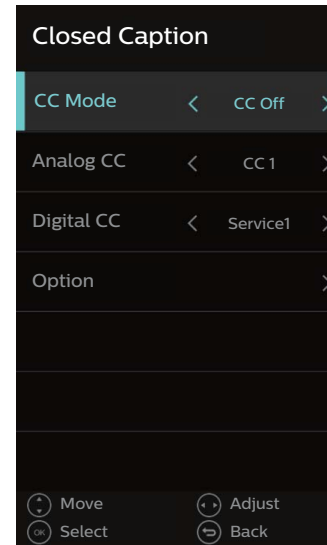

- 2 Use **▲▼◀▶** to select the feature you want to use. You can choose the closed caption display.

CC Mode	CC Off	Closed caption is not displayed.
	CC On	Closed caption is always displayed.
	CC On Mute	Closed caption is displayed when the sound is off.

### Cable / NTSC (Analog) TV operation

Analog CC	CC 1 and Text1	The primary closed captions and text services. The closed captions or text is displayed in the same language as the program's dialog (up to 4 lines of script on the TV screen).
	CC 3 and Text3	Serve as the preferred data channels. The closed captions or text is often a secondary language.
	CC 2, CC 4, Text2 and Text4	Rarely available and broadcasters use them only in special conditions, such as when <b>CC 1</b> and <b>CC 3</b> or <b>Text1</b> and <b>Text3</b> are not available.

## Digital TV operation

In addition to the basic closed caption, DTV has its own closed caption called digital caption service. Use this menu to change the settings for digital caption service.

Digital CC	Off	No Digital CC display
	Service1 to Service6	Select one of these before changing any other item in <b>Closed Caption</b> menu. Choose <b>Service1</b> under normal conditions.

You can choose the font (size, color, etc), background and other characteristics of the closed captions text.

Option	Mode		Set the look of digital Closed Captioning. Automatic uses broadcaster's style.
	Font	Font Style	Closed captioning font style, size, color and transparency (opacity) can be changed.
		Font Size	
		FG Color	
		FG Opacity	
	Background	BG Opacity	Background transparency (opacity) and color of the displayed caption can be switched.
		BG Color	
	Edge	Font Edge Style	Edge color and type of the displayed caption can be switched.
		Font Edge Color	

### Picture display

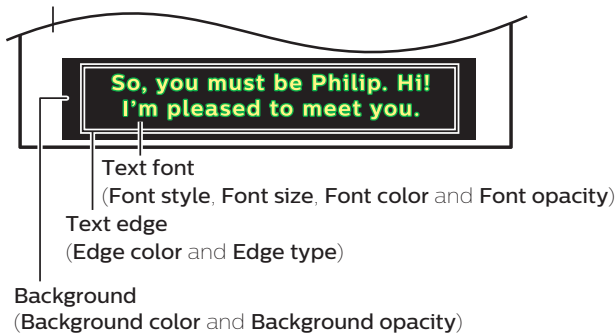

- Review your setting choice made above by looking in the upper right corner of the displayed setting box (not all selections show the differences selected).

### Note(s)

- Digital CC** that you can switch differs depending on the broadcast format.
- Closed captions service may not be controlled by this unit's menu options if you are watching television through a set-top box. In which case you will need to use the menu options on the external set-top box to control closed captions.
- The captions do not always use correct spelling and grammar. Not all TV programs and product commercials include closed captions information. Refer to your area TV program listings for the TV channels and times of closed captions shows. The closed captions programs are usually noted in the TV listings with a service mark such as **CC**.
- Not all closed captions services are used by a TV broadcaster during the transmission of a closed caption program.
- To show the closed caption on your TV screen, broadcast signal must contain the closed caption data.
- Captions and texts may not exactly match the TV voice.
- Changing channels may delay the closed caption for a few seconds.
- Adjusting or muting the volume may delay the closed caption for a few seconds.
- Abbreviations, symbols and other grammatical shortcuts may be used in order to keep pace with the on-screen action. This is not a malfunction.
- The caption or text characters will not be displayed while the main menu or functions display is shown.
- If a black box appears on the TV screen, this means that the closed caption is set to the text mode. To clear the box, select **CC 1**, **CC 2**, **CC 3**, or **CC 4**. Refer to **Closed Caption** → p. 28
- If the unit receives poor quality television signals (mainly when the analog (NTSC) is received), the captions may contain errors or there might be no captions at all. Some possible causes of poor quality signals are:
  - Automobile ignition noise
  - Electric motor noise
  - Weak signal reception
  - Multiplex signal reception (ghosts or screen flutter)
  - Data dropout and Pixelation (for DTV only)
- The unit retains the closed caption setting if the power fails.
- When the unit receives special effects playback signal (e.g. search, slow and still) from a VCR's video output channel (ch3 or ch4), the unit may not display the correct caption or text.
- The EUT (Equipment Under Test) setting that satisfies § 79.102 (e) is as follows:
  - Font: Mono-font
  - Character size: Large

## Over Scan

- 1 Use ▲▼ to select **Over Scan**, then use ◀▶ to select the item.

Off	To set <b>Over Scan</b> to <b>Off</b>
On	To set <b>Over Scan</b> to <b>On</b>

## Source Label

Create labels for the devices connected to your TV.

- 1 Use ▲▼ to select **Source Label**, then press **OK**.
- 2 Use ▲▼ to select the source and use ◀▶ to select **Default** / **Antenna** / **Cable** / **Satellite** / **DTV** / **DVD** / **Blu-ray** / **HD-DVD** / **XBOX** / **Wii** / **PS3** / **Game** / **Computer** / **VCR** / **DV** / **Custom**.

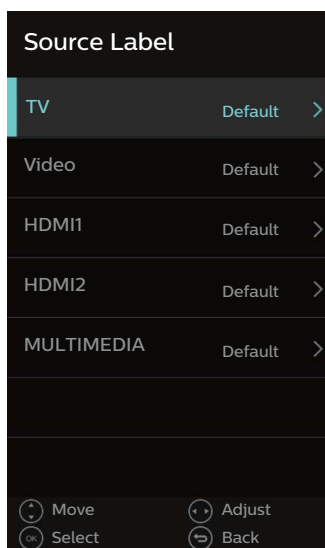

## Other Settings

Set the parameter of audio only, no signal power off and no operation power off.

- 1 Use ▲▼ to select **Other Settings**, then press **OK**.
- 2 Adjust the following items.

### Audio Only

Play the audio with the picture turned off.

Off	To set <b>Audio Only</b> to <b>Off</b>
On	When you turn the <b>Audio Only</b> on and exit the OSD menu, the panel will be dark, and then press any key to exit the <b>Audio Only</b> status.

## Restore Default

Change power on options or reset TV to factory default.

- 1 Use ▲▼ to select **Restore Default**, then press **OK**.
- 2 Use ◀▶ to select **Yes**, then press **OK**.

## Setup Wizard

Set the first time installation.

- 1 Use ▲▼ to select **Setup Wizard**, then press **OK**.
  - Only at TV source, the selection is displayed.
  - For detail please refer to **Setup wizard** → p. 15.

## CEC

This function allows you to operate the linked functions between our brand devices with a HDMI-CEC feature and this unit connecting through an HDMI cable. You must connect this unit to our brand HDMI-CEC devices and be sure it's HDMI-CEC setting is also set to On.

- 1 Use ▲▼ to select **CEC**, then press **OK**.

CEC	
CEC Control	On
Device Auto Power Off	Off
TV Auto Power On	Off
Audio Receiver	Off
Device Lists	
Connect	
<div style="display: flex; justify-content: space-between;"> <span>⊕ Adjust</span> <span>⊖ Back</span> </div>	

- 2 Use ▲▼ to select the item you want to adjust, then use ◀▶ to adjust it.

Set the **CEC Control** to **On** or **Off**. The following additional settings will be grayed out when you set them to **Off**.

CEC Control	Off	Disables all HDMI-CEC.
	On	Selects if you have connected an external device that is compatible with the HDMI-CEC function.

You can set your connected HDMI-CEC device to turn off by interlocking from this unit's power.

Device Auto Power Off	Off	Your connected HDMI-CEC device stays on even if the unit goes into standby mode.
	On	Your connected HDMI-CEC device turns off automatically when the unit goes into standby mode.

This unit will turn on when the power on signal is sent from your connected HDMI-CEC device.

TV Auto Power On	Off	This unit stays in standby mode even if you turn on your connected HDMI-CEC device.
	On	This unit turns on automatically when you turn on your connected HDMI-CEC device.

Audio receiver allows you to use CEC to output TV audio directly to a connected audio device, without the need for an additional digital audio cable. Only HDMI 1 mode has the audio receiver function.

Audio Receiver	Off	Disable HDMI-audio receiver.
	On	You can output TV audio through the HDMI cable solely, provided both the TV and device are HDMI-audio receiver compliant.

### Note(s)

- Some set-top boxes are not compatible with **CEC**, this is not a malfunction.

## Device Lists

Show the device list menu.

- 1 Use ▲▼ to select **Device Lists**, then press **OK** to enter the sub-menu.

## Connect

Connect the selected HDMI-CEC device.

- 1 Use ▲▼ to select **Connect**, then press **OK** to enter the sub-menu.

## Voice Guidance

Lets you configure voice guide and its settings.

- 1 Use ▲▼ to select **Voice Guidance**, then press **OK**.
- 2 Use ▲▼ to select the item you want to adjust, then use ◀▶ to adjust it.

Voice Guidance	Off	To set <b>Voice Guidance</b> to <b>Off</b>
	On	To set <b>Voice Guidance</b> to <b>On</b>
Volume	High	Set voice guide volume based on your preference
	Middle	
	Low	
Speed	Fast	Set voice guide speed based on your preference
	Normal	
	Slow	
Pitch	High	Set voice guide pitch based on your preference
	Middle	
	Low	

## Video Description

Change from the main audio to the secondary audio stream that contains video description, and vice versa.

- 1 Use ▲▼ to select **Video Description**, then use ◀▶ to select the item.

Off	To set <b>Video Description</b> to <b>Off</b>
On	To set <b>Video Description</b> to <b>On</b>

## E-sticker

E-sticker (Electronic Sticker) is displayed. E-sticker can be turned off using procedure below.

- 1 Use ▲▼ to select **E-sticker**.
- 2 Use ◀▶ to select **Off**.

Off	You can turn off <b>E-sticker</b> .
On	E-sticker is displayed of the TV screen.

## MULTIMEDIA

Your TV is fitted with a USB connection that enables you to view JPEG photos stored on a USB memory stick.

- 1 Connect the USB memory stick to the USB terminal on the back of your TV.
- 2 Press **Home** and use **Up/Down/Left/Right** to select **MULTIMEDIA**, then press **OK**.

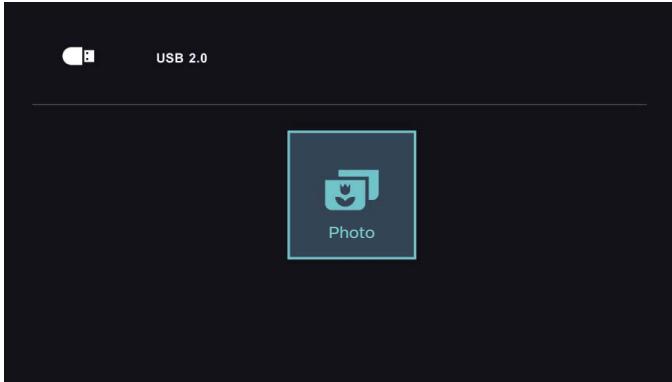

- 3 Select **Photo**, then press **OK**.

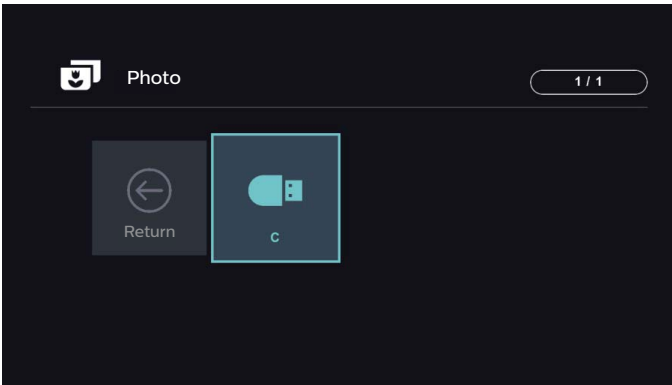

- 4 Use **Up/Down/Left/Right** to select the picture you want to watch, then press **OK**.
  - When highlighting the option you select, the file information will appear on the right and picture will be previewed in the center.
  - Use **Up/Down/Left/Right** to select the file folder you want to search in the file selecting menu, then press **OK** to enter the sub-menu.

Picture (JPEG)	Upper limit	4000 x 4000 pixels
----------------	-------------	--------------------

### Note(s)

- Up to 2GB (FAT16) or 8GB (FAT32) capacity can be supported.
- Up to 10,000 files or 1,000 folders with 19 hierarchies can be recognized.
- Up to 255 English characters can be recognized.
- This unit does not support MTP (Media Transfer Protocol).
- This unit supports FAT16 and FAT32 file systems.
- If the file is not supported, an error message appears.
- When the USB memory stick is not recognized, try reconnecting it again.
- We cannot be held responsible if your USB memory stick is not supported, nor will we accept any liability for damage or loss of stored data.
- To protect your USB memory stick files from being erased place the write protect sliding tab in the protect position (if available).
- Be sure to keep a backup copy of the original files on your device before you play them back on this unit.
- This unit does not recognize USB memory stick that requires a special driver.
- This unit is not allowed to use the USB memory stick which requires an external power supply (500mA or more).
- A file name exceeding 128 characters or contains a dot character is not supported on this TV.

## 6 Useful tips

### FAQ

Question	Answer
<p>My remote control does not work. What should I do?</p>	<ul style="list-style-type: none"> <li>• Check the antenna or cable connection to the main unit.</li> <li>• Check the batteries on the remote control.</li> <li>• Re-insert or replace the AAA batteries with their polarities (+/-) as indicated on the remote control battery area.</li> <li>• Check if there is an obstacle between the infrared sensor window and the remote control.</li> <li>• Test the IR signal output use <b>IR signal check</b>. ➔ p. 35 If okay, then possible infrared sensor trouble.</li> <li>• Aim the remote control directly at the infrared sensor window on the front of the unit.</li> <li>• Reduce the distance to the unit.</li> <li>• When there is an infrared-equipped device such as PC near this unit, it may interrupt the remote control signal on this unit. Move the infrared-equipped device away from this unit, change the angle of the device's infrared sensor or turn off the infrared communication function.</li> </ul>
<p>How come the setup wizard appears every time I turn on this unit?</p>	<ul style="list-style-type: none"> <li>• Connect the RF coaxial cable directly to this unit and run the setup wizard.</li> <li>• Make sure to complete the setup wizard before the unit goes into standby mode.</li> </ul>
<p>Why can I not watch some RF signal TV programs?</p>	<ul style="list-style-type: none"> <li>• Auto scan must be completed when you set up the unit for the first time or move it to a location where previously unavailable channels are broadcast.</li> <li>• Make sure <b>Auto Scan</b> has been completed. ➔ p. 23</li> <li>• The selected channel may not be broadcasting.</li> <li>• When <b>Auto Scan</b> is interrupted and not completed, some channels will not be received. Make sure to complete the auto scan. ➔ p. 23</li> <li>• The selected channel cannot be viewed by the <b>Child and ratings lock</b> setting. ➔ p. 25</li> <li>• The unit requires some kind of antenna input. An indoor antenna (Digital or VHF / UHF), an external antenna (Digital or VHF / UHF) or an RF coaxial cable from your wall cable or set-top box needs to be plugged into the unit.</li> </ul>
<p>How come there is no image from the connected external devices?</p>	<ul style="list-style-type: none"> <li>• Check the antenna, cable or other input connection to the unit.</li> <li>• When using the component video connection check that the green (Y), blue (Pb/Cb) and red (Pr/Cr) connectors are connected to their corresponding colored jacks on the unit.</li> </ul>
<p>When I enter a channel number, why does it change automatically?</p>	<ul style="list-style-type: none"> <li>• Many digital channels have alternate channel numbers. The unit changes the numbers automatically to the ones signifying the broadcasting station's channel number. These basic numbers used for the previous analog broadcasts. (e.g., input digital ch# 30 automatically changes to digital ch# 8.1)</li> </ul>
<p>Why are captions not displayed entirely? Or why are captions delayed behind the dialog?</p>	<ul style="list-style-type: none"> <li>• Closed captions that are delayed a few seconds behind the actual dialog are common for live broadcasts. Most captioning production companies can display a dialog to maximum of 220 words per minute. If a dialog exceeds that rate, selective editing is used to insure that the closed captions remain up-to date with the current TV screen dialog.</li> </ul>
<p>How can I set the clock?</p>	<ul style="list-style-type: none"> <li>• Switch to TIME menu, you can set the clock in Clock selection.</li> </ul>
<p>My PIN code no longer works, how can I change the child lock setting?</p>	<ul style="list-style-type: none"> <li>• If the PIN code no longer works, you can enter the "071 1" universal password to enter the <b>LOCK</b> menu, then change the lock password. Refer to <b>Child and ratings lock</b>. ➔ p. 25</li> </ul>

## Troubleshooting tips

If the unit does not perform properly when operated as instructed in this User manual,

**Please check the following Troubleshooting tips and all connections once before calling for service.**

### Power

#### No power

- Make sure the AC power cord is plugged in.
- Make sure that the AC outlet supplies the proper voltage, plug another electrical appliance into the AC outlet to ensure that the AC outlet operates normally.
- If a power failure occurs, unplug the AC power cord for 1 minute to allow the unit to reset itself.

### Remote

#### Control keys do not work.

- Do NOT press more than one key at the same time.
- Ensure that no keys on the remote control are depressed and move freely.
- **Universal remote control does not work properly.**
- Refer to the User manual of the universal remote control for the Philips code.

### Picture

#### Power is on but no screen image.

- Check whether the connection for the antenna, cable or set-top box is connected correctly.
- Check whether all the cables to the unit are connected to the correct output jack on your separate device like Blu-ray Disc™ / DVD recorder.
- Make sure that the selected input mode is connected to the working input jack.
- Check if your computer is NOT in sleep mode when the input mode on this unit is in PC mode. Tap any key on the computer keyboard to wake it up.

#### No color

- View other TV channels. The problem might be limited to the broadcasting station.
- Adjust **Color** in **PICTURE** settings. ➔ p. 21

#### Picture poor

- Adjust **Brightness** and **Contrast** in **PICTURE** settings. ➔ p. 21
- For the best picture quality, watch "High Definition" wide screen programs. If the HD content is not available, watch "Standard Definition" programs instead.

#### You see pixelation on the screen.

- When the capabilities of the unit exceed the capabilities of the digital broadcasting, the signal will be increased to match the capabilities of the display on the unit. This may cause pixelation, noise or trash.

#### Unusual picture appears and the TV does not operate.

- Press the power button first. If it does not solve the problem, then press the keys on the remote control in the order shown below to change the unit to the live mode.
- **SLEEP** ➔ **FORMAT** ➔ **▶** ➔ **▲** ➔ **▼** ➔ **⏻**
- Unplug the AC power cord, then wait for one minute, and then plug it in again.

### Sound

#### No sound, distorted sound or incorrect audio sound is heard when using the HDMI-DVI connections.

- Make sure that the analog audio signals from the HDMI-DVI device are connected to the analog audio (L/R) input jacks.
- Refer to **PC connection** ➔ p. 14
- When using Component analog video, Composite analog video or HDMI-DVI video make sure that the analog audio (L/R) connectors are mounted into the audio (L/R) input jacks.

#### Sound intermittent or no sound.

- Check if the audio cable is connected into the unit correctly.

#### You switch to a different input and the volume changes.

- This unit will memorize the volume level from the last time you adjusted it.
- If the volume of the sound from another device is higher or lower, then the loudness will change.
- Make sure **AVL** is set to **On**. ➔ p. 22

### Picture & Sound

#### No picture or sound

- Check if the power is on.
- Check whether all the cables to the unit are connected to the correct output jack of your device like Blu-ray Disc™ / DVD recorder.
- View other TV channels. The problem might be limited to the broadcasting station or weak signal strength, if DTV channel check signal strength.
- Unplug the AC power cord and wait for about 1 minute, then plug the AC power cord and turn on the unit again.
- Check whether the connection of the antenna or cable or set-top box is connected correctly.
- Make sure that the selected input mode is connected to the working input jack.
- Check if your computer is NOT in sleep mode when the input mode of this unit is in HDMI mode. Tap any key on the keyboard to wake up your computer.
- Make sure that the sound is not muted. Press **MUTE** so that the volume bar and current volume level will appear on the TV screen.

#### You see a distorted picture or hear an unusual sound. (Analog TV - NTSC signal)

- You may be getting interference from electrical appliances, automobiles, motorcycles or fluorescent lights.
- Try moving the unit to another location to see if this is the cause of the problem.

#### Ghosts, lines or streaks in picture. (Analog TV- NTSC signal)

- Electrical interference from nearby appliances may affect picture quality.
- View other TV channels. The problem might be limited to the broadcasting station or weak signal strength, if DTV channel check signal strength.

#### Picture poor, sound intermittent or no sound

- View other TV channels. The problem might be limited to the broadcasting station or weak signal strength, if DTV channel check signal strength.

### Screen

#### You switch to a different input and the screen size changes.

- This unit will memorize the viewing mode from the last time you used those particular input modes.

#### The display image does not cover the entire screen.

- If you are watching TV or using the Composite video, Component video or HDMI with 480i input, press **FORMAT** repeatedly to switch to various screen modes.

#### Different color marks on the TV screen

- View other TV channels. The problem might be limited to the broadcasting station, missing data or pixelation due to weak signal strength.

### Closed captions

#### Closed captions are displayed as a white box. No closed captions are displayed in the closed captions-supported program.

- Interference from buildings or weather conditions may cause captioning to be incomplete if watching Analog TV signals.
- Broadcasting station may shorten the program to insert advertisements.
- The closed captions decoder cannot read the information of a shortened program.

#### Black box is displayed on the TV screen.

- The text mode is selected. For closed captions, select **CC 1**, **CC 2**, **CC 3** or **CC 4**. ➔ p. 28
- If connected to a Blu-ray Disc™ / DVD device then closed captions are part of its video signal and is only controlled through this device's menu or remote control. Remove the TV closed captions mode.

### Note(s)

- The LCD screen is manufactured to provide many years of useful life. Occasionally a few non active pixels may appear as a fixed point of blue, green or red. This is not to be considered a defect in the LCD screen.
- Some functions are not available in specific modes, but this is not a malfunction. Read the description in this User manual for more details on correct operations of this unit.



# 7 Information

## Glossary

### Analog TV (NTSC)

Acronym that stands for National Television Systems Committee and the name of analog broadcasting standards.

Off the air analog TV signals are no longer being sent by major broadcasting stations in the USA.

### Aspect ratio

The width of a TV screen relative to its height. Conventional TVs are 4:3 (in other words, the TV screen is almost square); widescreen models are 16:9 (the TV screen is almost twice as wide as its height).

### CEC (Consumer Electronics Control)

This allows you to operate the linked functions between our brand devices with CEC feature and this unit. We do not guarantee 100% interoperability with other brands of CEC compliant devices.

### Component video

This is a Video signal format that conveys each of 3 principal colors of light (red, blue and green) through different signal lines. This allows the viewers to experience picture colors as original as it is. There are several signal formats, including Y / Pb / Pr and Y / Cb / Cr.

### Dolby Digital

The system developed by Dolby Laboratories to compress digital sound. It offers stereo sound (2ch) or multi-channel audio.

### DTV (ATSC)

Abbreviation that stands for Advanced Television Systems Committee and the name of the digital broadcasting standards.

### E-sticker

E-sticker is showing set features, technical information, etc on this TV set that is displayed on the TV screen mainly used by TV retailers. Previously the information was on a printed sticker that was put on the display.

### HDMI (High-Definition Multimedia Interface)

Interface that supports all uncompressed, digital audio / video formats including set-top box, Blu-ray Disc™ / DVD recorder or digital television, over a single cable.

### HDTV (High-Definition TV)

Ultimate digital format that produces high resolution and high picture quality.

### PIN code

A stored 4-digit number that allows access to parental control features.

### SAP (Secondary Audio Program)

Second-audio channel delivered separately from the Main-audio channel. This audio channel is used as an alternate in bilingual broadcasting.

### SDTV (Standard Definition TV)

Standard digital format that is similar to the analog TV picture quality.

## Maintenance

### Cleaning

- Clean the front panel and other exterior surfaces of the unit with a soft microfiber cloth or lens brush. Before cleaning the panel, disconnect the AC power cord.
- Never use a solvent or alcohol. Do not spray insecticide liquid near the unit. Such chemicals may cause damage and discoloration to the exposed surfaces.
- Do not spray any liquids on the screen or other exterior surfaces of this unit. If liquids enter the unit, they could cause shorts, electric shocks or fire damage.



### Servicing

Should your unit become inoperative, Do not try to correct the problem yourself. There are no user serviceable parts inside. Call our toll free customer support line found on the cover of this User manual to locate an authorized service center.

### IR signal check

If the remote control is not working properly, you can use a digital or cell phone camera to see if it is sending out an infrared signal.



e.g.) With a digital camera:

Point the digital camera towards the remote control infrared diode at the front of the remote control. Press and hold any key on the remote control and look at the camera display. If an infrared pulsating light appears on the display, the remote control is sending out an IR signal.

**Note:** Some cameras may have an IR filter or dual camera cell phones may have an IR filter in one of the camera's and both will not display the IR signal.

# 8 Specifications

Model #		24PFL3603
<b>Picture</b>		
Type	HD (1366 x 768 pixels 60 Hz)	
Diagonal screen size / Aspect ratio	23.6" / 16:9	
Viewing angles	178° (V) by 178° (H)	
Built-in digital / analog tuner	ATSC (digital) / NTSC (analog)	
<b>Sound</b>		
Mono / Stereo	Mono, Stereo, SAP	
Power output (RMS watts)	2.5W x 2	
<b>Ease of use</b>		
Picture format	SD	Wide / Zoom / Cinema / Normal
	HD	Wide / Zoom / Cinema / Normal
	HDMI-DVI	Full / Point to Point
Photo slide show	JPEG files only	
<b>Channel</b>		
Channel coverage	Over-the-Air DTV (ATSC)	VHF: 2~13 UHF: 14~69 (Each channel may have e.g. 2.1~2.9, 3.1~3.9, etc)
	Over-the-Air Analog (NTSC)	VHF: 2~13 UHF: 14~69
CATV (Analog NTSC)	2~13, A~W W+1~W+94 (Analog W+1~W+84), A-5~A-1, 5A	
Tuning system	Channel frequency synthesized tuning system	
Channel access	Direct access number keyboard, Programmable scan, Channel + (up) / - (down) and PREV. CH (Previous channel)	
<b>Connectivity</b>		
Component video input (Y/Pb/Pr)	1 Supporting video signals : 480i/p, 720p, 1080i/p @60Hz	
Composite video input (Shared Y green terminal with component video)	1	
HDMI input	2	
	Supporting HDMI video signals : 480i/p, 720p, 1080i @60Hz, 1080p @24/30/60Hz Supporting PC-input video signal up to WXGA (1366 x 768)	
Analog audio L/R input	1 (L audio / R audio)	
PC input	Via HDMI and HDMI-DVI + Analog audio L/R	
USB	1	
Digital audio output	1 Supporting Dolby Audio (Dolby Digital and Dolby Digital Plus)	
Headphone output	1 1/8 inch (3.5mm)	
<b>Power</b>		
Power requirements	120V~ +/- 10%, 60Hz +/- 0.5%	
<b>Temperature</b>		
Operating temperature	41 °F (5 °C) to 104 °F (40 °C)	

- Specifications are subject to change without prior notice.

# 9 Warranty

## LIMITED WARRANTY ONE (1) YEAR

### WARRANTY COVERAGE:

This warranty obligation is limited to the terms as set forth below.

### WHO IS COVERED:

This product warranty is issued to the original purchaser or the person receiving the product as a gift against defects in materials and workmanship as based on the date of original purchase ("Warranty Period") from an Authorized Dealer. The original sales receipt showing the product name and the purchase date from an authorized retailer is considered such proof.

### WHAT IS COVERED:

This warranty covers new products if a defect in material or workmanship occurs and a valid claim is received within the warranty period. At its option, the company will either (1) repair the product at no charge, using new or refurbished replacement parts, or (2) exchange the product with a product that is new or which has been manufactured from new, or serviceable used parts and is at least functionally equivalent or most comparable to the original product in current inventory, or (3) refund the original purchase price of the product.

Replacement products or parts provided under this warranty are covered against defects in materials and workmanship from the date of the replacement or repair for ninety (90) days or for the remaining portion of the original product's warranty, whichever provides longer coverage for you. When a product or part is exchanged, any replacement item becomes your property and the replaced item becomes company property. When a refund is given, your product becomes company property.

**Note:** Any product sold and identified as refurbished or renewed carries a ninety (90) day limited warranty.

Replacement product can only be sent if all warranty requirements are met. Failure to follow all requirements can result in delay.

### WHAT IS NOT COVERED - EXCLUSIONS AND LIMITATIONS:

This limited warranty applies only to new company manufactured products that can be identified by the trademark, trade name, or logo affixed to it. This limited warranty does not apply to any hardware product or any software, even if packaged or sold with the product, as manufacturers, suppliers, or publishers may provide a separate warranty for their own products packaged with the bundled product.

The company is not liable for any damage to or loss of any programs, data, or other information stored on any media contained within the product, or other additional product or part not covered by this warranty. Recovery or reinstallation of programs, data or other information is not covered under this limited warranty.

This warranty does not apply (a) to damage caused by accident, abuse, misuse, neglect, misapplication, or non-supplied product, (b) to damage caused by service performed by anyone other than company approved Authorized Service Location, (c) to a product or a part that has been modified without written company permission, or (d) if any serial number has been removed or defaced, or (e) product, accessories or consumables sold "AS IS" without warranty of any kind by including refurbished product sold "AS IS" by some retailers.

*This warranty gives you specific legal rights. You may have other rights which vary from state/province to state/province.*

### This limited warranty does not cover:

- Shipping charges to return defective product.
- Labor charges for installation or setup of the product, adjustment of customer controls on the product, and installation or repair of antenna/signal source systems outside of the product.
- Product repair and/or part replacement because of improper installation or maintenance, connections to improper voltage supply, power line surge, lightning damage, retained images or screen markings resulting from viewing fixed stationary content for extended periods, product cosmetic appearance items due to normal wear and tear, unauthorized repair or other cause not within the control of the company.
- Damage or claims for products not being available for use, or for lost data or lost software.
- Damage from mishandled shipments or transit accidents when returning product.
- A product that requires modification or adaptation to enable it to operate in any country other than the country for which it was designed, manufactured, approved and/or authorized, or repair of products damaged by these modifications.
- A product used for commercial or institutional purposes (including but not limited to rental purposes).
- Product lost in shipment and no signature verification receipt can be provided.
- Failure to operate per User manual.

### TO OBTAIN ASSISTANCE...

Contact the Customer Care Center at:  
1-866-813-3283

REPAIR OR REPLACEMENT AS PROVIDED UNDER THIS WARRANTY IS THE EXCLUSIVE REMEDY FOR THE CONSUMER, WITH THE ISSUING COMPANY NOT LIABLE FOR ANY INCIDENTAL OR CONSEQUENTIAL DAMAGES FOR BREACH OF ANY EXPRESS OR IMPLIED WARRANTY ON THIS PRODUCT. EXCEPT TO THE EXTENT PROHIBITED BY APPLICABLE LAW, ANY IMPLIED WARRANTY OF MERCHANTABILITY OR FITNESS FOR A PARTICULAR PURPOSE ON THIS PRODUCT IS LIMITED IN DURATION TO THE DURATION OF THIS WARRANTY.

Some states do not allow the exclusions or limitation of incidental or consequential damages, or allow limitations on how long an implied warranty lasts, so the above limitations or exclusions may not apply to you.

# License

Funai Corporation, Inc. hereby offers to deliver, upon request, a copy of the complete corresponding source code for the copyrighted open source code packages, on an "AS IS" basis, used in this product for which such offer is requested by the respective licenses. This offer is valid up to three years after the product purchase to anyone in receipt of this information. To obtain source code, please contact Funai Corporation, Inc. You should write to Funai Service Corporation OSS Request, 1880 Braselton Hwy, Suite 118 #5012 Lawrenceville, GA 30043. Funai Corporation, Inc. disclaims any and all warranties and representations with respect to such software and related source code including quality, reliability, usability, and accuracy, and further disclaim all express, implied, statutory or otherwise, including without limitation, any implied warranties of title, non-infringement, merchantability, or fitness for a particular purpose. Funai Corporation, Inc. shall not be liable to make any corrections to the open source software or source code or to provide any support or assistance with respect to it. Funai Corporation, Inc. disclaims any and all liability arising out of or in connection with the use of this software and/or source code.



Funai Corporation, Inc.  
19900 Van Ness Avenue, Torrance, CA 90501 U.S.A.

P&F Mexicana, S.A. de C.V.  
Av. La Palma No. 6, Col. San Fernando La Herradura.  
Huixquilucan, Edo. de México. C.P. 52787

This product has been manufactured by and is sold under the responsibility of Funai Corporation, Inc., and Funai Corporation, Inc. is the warrantor in relation to this product.

The Philips trademark and the Philips Shield Emblem are registered trademarks of Koninklijke Philips N.V. used under license.

ABLLOU2-24HB  
★★★★★