

# **SALORA**

**GEBRUIKSAANWIJZING  
BEDIENUNGSANLEITUNG  
OPERATING INSTRUCTIONS  
MODE D'EMPLOI**

**32LED9115CDW**

**KLEURENTELEVISIE MET AFSTANDSBEDIENING  
FARBFERNSEHGERÄT MIT FERNBEDIENUNG  
COLOUR TELEVISION WITH REMOTE CONTROL  
TELEVISEUR COULEUR A TELECOMMANDE**

## Contents

⚠ Safety Information.....	44
Getting Started.....	45
Notifications & Features & Accessories.....	45
Features .....	45
Inserting the Batteries into the Remote .....	46
Connect Power .....	46
Antenna Connection.....	46
Remote Control .....	47
Connections.....	48
Media Browser Menu.....	50
Quick Menu .....	50
TV Menu Features and Functions .....	51
General TV Operation .....	53
Using the Channel List .....	53
Configuring Parental Settings.....	53
Electronic Programme Guide (EPG) .....	53
Software Upgrade.....	54
Troubleshooting & Tips.....	54
AV and HDMI Signal Compatibility .....	55
DVD Mode.....	56
Notes on Discs .....	56
Licence Notification .....	56
How to Watch a DVD.....	56
DVD Control Panel Buttons.....	57
Overview of the Remote Control .....	57
General Operation .....	58
General Playback .....	59
DVD Troubleshooting .....	59
Disc Types Compatible with This Unit .....	60
Specifications .....	60

 **Safety Information**



**CAUTION:** TO REDUCE THE RISK OF ELECTRIC SHOCK DO NOT REMOVE COVER (OR BACK). NO USER-SERVICEABLE PARTS INSIDE. REFER SERVICING TO QUALIFIED SERVICE PERSONNEL.

**To operate your TV in extreme ambient conditions may cause the damage of the device.**



In extreme weather (storms, lightning) and long inactivity periods (going on holiday) disconnect the TV set from the mains. The mains plug is used to disconnect the TV set from the mains and therefore it must remain readily operable.





This sign is present wherever there is very important information regarding the operation and maintenance of the appliance in the literature accompanying it.





**Note:** Follow the on screen instructions for operating the related features.

 **IMPORTANT - Please read these instructions fully before installing or operating**

**WARNING:** Never let people (including children) with reduced physical, sensory or mental capabilities or lack of experience and / or knowledge use electrical devices unsupervised.

- For ventilation purposes, leave a free space of at least 10 cm all around the set.
- **Do not** block ventilation holes.
- **Do not** place the TV on sloping or unstable surfaces, the TV may tip over.
- Use this device in moderate climates.
- The power cord plug should be easily accessible. **Do not** place the TV, furniture, etc. on the power cord. A damaged power cord/plug can cause fire or give you an electric shock. Handle the power cord by the plug, **do not** unplug the TV by pulling the power cord. Never touch the power cord/plug with wet hands as this could cause a short circuit or electric shock. Never make a knot in the power cord or tie it with other cords. When damaged it must be replaced, this should only be done by qualified personnel.
- **Do not** use this TV in a humid or damp environment. Do not expose the TV to liquids. In case the cabinet contacts any liquids unplug the TV immediately and have it checked by qualified personnel before operating it any further.
- **Do not** expose the TV to direct sunlight, open flames or place it near intense heat sources such as electric heaters. 
- Listening in excessive volumes from earphones and headphones may cause hearing loss.
- Ensure that no open flame sources, such as lit candles, are placed on top of the TV. 
- To prevent injuries, this TV must be securely attached to a wall carefully by following the instructions (if the option is available).

- Occasionally, a few non-active pixels may appear on the screen as a fixed blue, green or red point. Please note that this does not affect the performance of your product. Take care not to scratch the screen with fingernails or other hard objects.
- Before cleaning, unplug the TV from the wall socket. Only use a soft, dry cloth while cleaning.

 Warning	Serious injury or death risk
 Risk of electric shock	Dangerous voltage risk
 Caution	Injury or property damage risk
 Important	Operating the system correctly
 Notice	Additional notes marked

# Getting Started

## Notifications & Features & Accessories

### Environmental Information

This television is designed to consume less energy to help save the environment. To reduce energy consumption, you should take the following steps:

If you set the Power Save Mode as **Eco**, the TV will switch to energy-saving mode. The Power Save Mode settings can be found in the 'Picture' section of the Main Menu. Note that some picture settings will be unavailable to be changed.

If **Picture Off** is selected, "Screen will be off in 3 seconds." message will be displayed. Select **PROCEED** and press **OK** to continue. The screen will be off immediately.

When the TV is not in use, please switch off or disconnect the TV from the mains plug. This will also reduce energy consumption.

### Standby Notifications

1) If the TV does not receive any input signal (e.g. from an aerial or HDMI source) for 5 minutes, the TV will go into standby. When you next switch-on, the following message will be displayed: "**Standby Cause No Signal**" Press **OK** to continue.

2) If the TV has been left on and not been operated for a while, the TV will go into standby. When you next switch-on, the following message will be displayed. "**Standby Cause No Operation**" Press **OK** to continue.

### Features

- Remote controlled colour LED TV.
- Fully integrated digital/cable/satellite TV (DVB-T/C)
- HDMI inputs are for connecting a device that has a HDMI socket.
- USB input.
- OSD menu system.
- Scart socket for external devices (such as DVD Players, PVR, video games, etc.)
- Stereo sound system.
- Teletext.
- Headphone connection.
- Automatic programming system.
- Manual tuning.
- Automatic power down after up to six hours.
- Sleep timer.
- Child lock.
- Automatic sound mute when no transmission.
- NTSC playback.
- AVL (Automatic Volume Limiting).

- PLL (Frequency Search).
- PC input.
- Plug&Play for Windows 98, ME, 2000, XP, Vista, Windows 7.
- Game Mode (Optional).

### Accessories Included

- Remote Control
- Batteries: 2 x AAA
- Instruction Book

### TV Control Switch & Operation

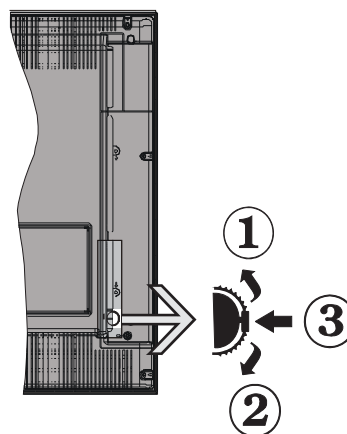

1. Up direction
2. Down direction
3. Programme/Volume / AV / Standby-On selection switch

The Control button allows you to control the Volume/ Programme/ Source and Standby-On functions of the TV.

**To change volume:** Increase the volume by pushing the button up. Decrease the volume by pushing the button down.

**To change channel:** Press the middle of the button, the channel information banner will appear on screen. Scroll through the stored channels by pushing the button up or down

**To change source:** Press the middle of the button twice, the source list will appear on screen. Scroll through the available sources by pushing the button up or down.

**To turn the TV off:** Press the middle of the button down and hold it down for a few seconds, the TV will turn into standby mode.

### Inserting the Batteries into the Remote

Lift the cover on the back of the remote upward gently. Install two **AAA** batteries. Make sure to match the + and - ends of the batteries in the battery compartment (observe the correct polarity) Replace the cover.

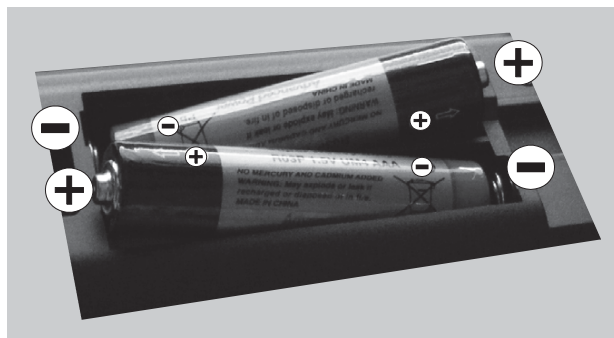

### Connect Power

**IMPORTANT:** The TV set is designed to operate on **220-240V AC, 50 Hz** socket. After unpacking, allow the TV set to reach the ambient room temperature before you connect the set to the mains. Plug the power cable to the mains socket outlet.

### Antenna Connection

Connect the “aerial” or “cable TV” plug to AERIAL INPUT (ANT) socket located on the back of the TV.

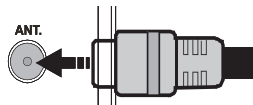

### Notification

Manufactured under license from Dolby Laboratories.

#### TRADEMARK ACKNOWLEDGMENT

“Dolby” and the double-D symbol are trademarks of Dolby Laboratories.



“HDMI, the HDMI logo and High-Definition Multimedia Interface are trademarks or registered trademarks of HDMI Licensing LLC.”



### Information for Users on Disposal of Old Equipment and Batteries

#### [European Union only]

These symbols indicate that equipment with these symbols should not be disposed of as general household waste. If you want to dispose of the product or battery, please consider the collection systems or facilities for appropriate recycling.

**Notice:** The sign *Pb* below the symbol for batteries indicates that this battery contains lead.

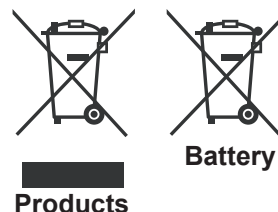

### Specification

<b>TV Broadcasting</b>	PAL B/G D/K K I/I'
<b>Receiving Channels</b>	VHF (BAND I/III) - UHF (BAND U) - HYPERBAND
<b>Number of Preset Channels</b>	1000
<b>Channel Indicator</b>	On Screen Display
<b>RF Aerial Input</b>	75 Ohm (unbalanced)
<b>Operating Voltage</b>	220-240V AC, 50Hz.
<b>Audio</b>	German+Nicam Stereo
<b>Audio Output Power (WRMS.) (10% THD)</b>	2 x 6
<b>Power Consumption</b>	65 W
<b>Weight</b>	9,40
<b>TV Dimensions DxLxH (with foot)</b>	185 x 735 x 478
<b>TV Dimensions DxLxH (without foot)</b>	61/68 x 735 x 438
<b>Operation temperature and operation humidity:</b>	0°C up to 40°C, 85% humidity max

# Getting Started

## Remote Control

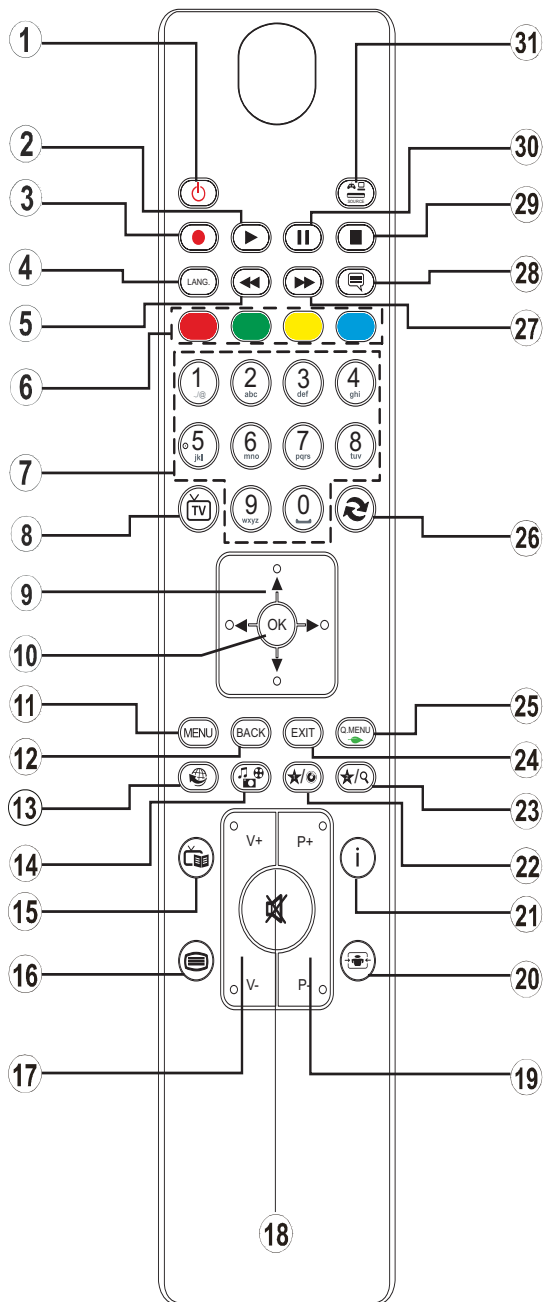

1. Standby / On
2. Play (in media browser mode)
3. No function
4. Mono-Stereo Dual I-II / Current language (in DVB channels)
5. Rapid reverse (in media browser mode)
6. Coloured buttons (Red, Green, Yellow, Blue)
7. Numeric buttons
8. Channel list
9. Navigation buttons
10. OK (Confirm) / Hold (in TXT mode)
11. Menu on / off
12. Return / Back / Index page (in TXT mode)
13. No function
14. Media browser
15. Electronic programme guide (in DVB channels)
16. Teletext / Mix
17. Volume up / down
18. Mute button
19. Programme up / down
20. Image size
21. Info / Reveal (in TXT mode)
22. My button 1 (\*)
23. My button 2 (\*\*)
24. Exit
25. Quick Menu
26. Previous programme
27. Rapid advance (in media browser mode)
28. Subtitle on-off (in DVB channels & media browser mode)
29. Stop (in media browser mode)
30. Pause (in media browser mode)
31. AV / Source

### MY BUTTON 1

Press MY BUTTON 1 for five seconds when on a desired source, channel or link, until the "MY BUTTON IS SET" message is displayed on the screen. This confirms that the selected MY BUTTON is now associated with the selected function.

### MY BUTTON 2

Press MY BUTTON 2 for five seconds when on a desired source, channel or link, until the "MY BUTTON IS SET" message is displayed on the screen. This confirms that the selected MY BUTTON is now associated with the selected function.

### Teletext











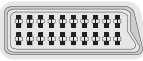

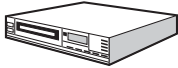
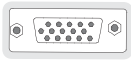

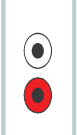



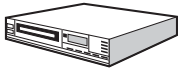



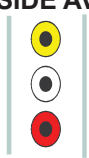



Press button to enter. Press again to activate mix mode. Press once more to exit. Follow the instructions displayed on digital teletext screen.

### Digital Teletext (for UK only)

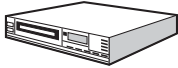
Press button to view digital teletext information. Operate it with the coloured buttons, cursor buttons and the **OK** button. The operation method may differ depending on the contents of the digital teletext. Follow the instructions displayed on the digital teletext screen. When the button is pressed again, the TV returns to television broadcast.

# Getting Started

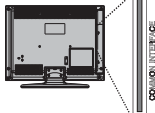
## Connections

Connector	Type	Cables	Device
	Scart Connection (back)		
	VGA Connection (back)		
	PC/YPbPr Audio Connection (side)	 Side Audio YPbPr or PC Connection Cable	
	HDMI Connection (back)		
	SPDIF Connection (back)		
	Side AV (Audio/Video) Connection (side)		
	Headphone Connection (side)		
	YPbPr Video Connection (side)	 YPbPr Connection Cable	
	USB Connection (side)		
	CI Connection (side)		

 **NOTE:** When connecting a device via the Side AV input, you must use a connection cable to enable connection. See the illustrations above. To enable PC audio, you will need to use the SIDE AV CONNECTION cable's WHITE & RED inputs. If an external device is connected via the SCART socket, the TV will automatically switch to AV mode. When receiving DTV channels (Mpeg4 H.264) or while in Media Browser mode, output will not be available via the scart socket. When using the wall mounting kit (optional), we recommend that you plug all your cables into the back of the TV before mounting on the wall. Insert or remove the CI module only when the TV is SWITCHED OFF. You should refer to the module instruction manual for details of the settings. By connecting an HDMI cable to your TV, you have to use only a shielded HDMI cable to guarantee a sufficient immunity against parasitic frequency radiation.

# Getting Started

## First Time Installation - USB Connections

### Switching On/Off

#### To Switch the TV On

Connect the power cord to the 220-240V AC, 50 Hz.

To switch on the TV from standby mode either:

Press the “” button, **P+** / **P-** or a numeric button on the remote control.

Press the side function switch until the TV comes on from standby.

#### To Switch the TV Off

Press the “” button on the remote control or press the side function switch until the TV switches into standby mode.

**To power down the TV completely, unplug the power cord from the mains socket.**

**Note:** When the TV is switched to standby mode, the standby LED can blink to indicate that features such as Standby Search, Over Air Download or Timer is active. The LED can also blink when you switch on the TV from standby mode.

### First Time Installation

When turned on for the first time, the language selection screen is displayed. Select the desired language and press OK.

The First Time Installation (FTI) screen will be displayed next. Set your preferences using the navigation buttons and when finished, press OK to continue.

You can activate **Store mode** option to be available in “Other settings” menu and your TV’s features will be illustrated on the top of the screen. A confirmation screen will be displayed. Select **YES** to proceed.

If Home Mode is selected, Store mode will not be available after the First Time Installation. Press **OK** button to continue.

### Aerial Installation

If you select **AERIAL** option from the **Search Type** screen, the television will search for digital terrestrial TV broadcasts.

 **NOTE:** You can press **MENU** button to cancel.

After all the available stations are stored, the Channel List will be displayed on the screen. If you like how the channels are sorted according to the LCN (\*), please select “Yes” and then press **OK**.

Press **MENU** button to quit channel list and watch TV.

(\* LCN is the Logical Channel Number system that organizes available broadcasts in accordance with a recognizable channel sequence (if available).

### Cable Installation

If you select CABLE option and press OK button on the remote control. To continue, please select YES and press OK. To cancel operation, select NO and press OK. You can select frequency ranges from this screen.

Enter the frequency range manually by using the numeric button.

**Note:** Searching duration will change depending on the selected search step.

### Media Playback via USB Input

You can connect a 2.5” and 3.5” inch (hdd with external power supply) external hard disk drives or USB memory stick to your TV by using the USB inputs of the TV.





**IMPORTANT!** Back up your files before making any connections to the TV. Manufacturer will not be responsible for any file damage or data loss. Certain types of USB devices (e.g. MP3 Players) or USB hard disk drives/memory sticks may not be compatible with this TV. The TV supports FAT32 and NTFS disk formatting.

While formatting a USB hard disk that has 1TB (Tera Byte) or more file capacity, you can experience problems with the formatting process. Do not repeatedly quickly plug and unplug the drive. This may cause physical damage to the USB player and USB device itself. Do not pull out USB module while playing a file.



## Media Browser Menu

You can play photo, music, and movie files stored on a USB disk by connecting it to your TV. Connect a USB disk to one of the USB inputs located on the side of the TV. Pressing the **Menu** button while in the Media Browser mode will access the Picture, Sound and Settings menu options. Pressing the **Menu** button again will exit from this screen. You can set your Media Browser preferences by using the Settings Menu.

<i>Loop/Shuffle Mode Operation</i>	
Start playback with  and activate 	TV plays next file and loop the list.
Start playback with <b>OK</b> and activate 	The same file will be played in a loop (repeat).
Start playback with <b>OK</b> /  and activate 	The file will be played in a shuffle.

## Quick Menu

Quick Settings menu allows you to access some options quickly. This menu includes Power Save Mode, Picture Mode, Equalizer Settings, Favourites and Sleep Timer options. Press **Q.MENU** button on the remote control to view quick menu. See the following chapters for the details of the listed features.

## TV Menu Features and Functions

Picture Menu Contents	
<b>Mode</b>	You can change the picture mode to suit your preference or requirements. Picture mode can be set to one of these options: <b>Cinema,Game,Dynamic</b> and <b>Natural</b> .
<b>Contrast</b>	Sets the lightness and darkness values of the screen.
<b>Brightness</b>	Sets the brightness value for the screen.
<b>Sharpness</b>	Sets the sharpness value for the objects displayed on the screen.
<b>Colour</b>	Sets the colour value, adjusting the colors.
<b>Power Save Mode</b>	To set the Power Save Mode as Eco, Picture Off and Disabled. (When the Mode is Dynamic, Power Save mode is automatically set as disabled.)
<b>Backlight (Optional)</b>	This setting controls the backlight level. The backlight function will be inactive if the Power Save Mode is set to Eco. The backlight cannot be activated in VGA, Media Browser mode or while the picture mode is set to Game.
<b>Noise Reduction</b>	If the broadcast signal is weak and the picture is noisy, use the <b>Noise Reduction</b> setting to reduce the amount of noise.
Advanced Settings	
<b>Dyanmic Contrast</b>	You can change the Dynamic Contrast ratio to desired value.
<b>Colour Temp</b>	Sets the desired colour tone.
<b>Picture Zoom</b>	Sets the desired picture size from picture zoom menu. <i>Note: Auto (Only available in Scart mode with SCART PIN8 high voltage/low voltage switching)</i>
<b>Film Mode</b>	Films are recorded at a different number of frames per second to normal television programmes. Turn this feature on when you are watching films to see the fast motion scenes clearly.
<b>Skin Tone</b>	Skin tone can be changed between -5 and 5.
<b>Colour Shift</b>	Adjusts the desired colour tone.
<b>RGB Gain</b>	You can configure the colour temperature values using the RGB Gain feature.
<b>Reset</b>	Resets the picture settings to factory default settings.(Except Game Mode)
<b>Autoposition (in PC mode)</b>	Automatically optimizes the display. Press OK to optimize.
<b>H Position (in PC mode)</b>	This item shifts the image horizontally to the right hand side or left hand side of the screen.
<b>V Position (in PC mode)</b>	This item shifts the image vertically towards the top or bottom of the screen.
<b>Dot Clock (in PC mode)</b>	Dot Clock adjustments correct the interference that appear as vertical banding in dot intensive presentations like spreadsheets or paragraphs or text in smaller fonts.
<b>Phase (in PC mode)</b>	Depending on the resolution and scan frequency that you input to the TV set, you may see a hazy or noisy picture on the screen. In such a case you can use this item to get a clear picture by trial and error method.
<i>While in VGA (PC) mode, some items in Picture menu will be unavailable. Instead, VGA mode settings will be added to the Picture Settings while in PC mode.</i>	

<b>Sound Menu Contents</b>	
<b>Volume</b>	Adjusts the volume level.
<b>Equalizer</b>	Selects the equalizer mode. Custom settings can be made only when in user mode.
<b>Balance</b>	This setting is used for emphasizing left or right speaker balance.
<b>Headphone</b>	Sets headphone volume.
<b>Sound Mode</b>	You can select a sound mode. (If the selected channel supports).
<b>AVL (Automatic Volume Limiting)</b>	Function sets the sound to obtain fixed output level between programmes.
<b>Digital Out</b>	Sets digital out audio type.
<b>Settings Menu Contents</b>	
<b>Conditional Access</b>	Controls conditional access modules when available.
<b>Language</b>	Configures language settings (may change depending on the country selected) Preferred and current settings will be available. Current settings can be changed only if the broadcaster supports.
<b>Parental</b>	Enter correct password to change parental settings. You can easily adjust menu lock, maturity lock(may change depending on the country selected) and child lock in this menu. You can also set new pin number.
<b>Timers</b>	Sets sleep timer to turn off the TV after a certain time. Sets timers for selected programmes. (USB Record)
<b>Date/Time</b>	Sets date and time.
<b>Sources</b>	Enables or disables selected source options.
<b>Other Settings: Displays other setting options of the TV set:</b>	
<b>Menu Timeout</b>	Changes timeout duration for menu screens.
<b>Scan Encrypted Channels</b>	When this setting is on, the search process will locate the encrypted channels as well.
<b>Blue Background</b>	Activates or deactivates the blue background system when the signal is weak or absent.
<b>Software Upgrade</b>	To ensure that your TV always has the most up to date firmware.
<b>Application Version</b>	Displays application version.
<b>Hard of Hearing</b>	Enables any special feature sent from the broadcaster.
<b>Audio Description</b>	Audio description refers to an additional narration track for blind and visually impaired viewers of visual media, including television and movies. You can use this feature, only if the broadcaster supports that additional narration track. Note: Audio description sound feature cannot be available in recording or time shifting mode..
<b>Auto TV Off</b>	You can set the timeout value of auto off feature. When the timeout value is reached and the TV has not been operated for a selected time, the TV will go into standby mode.
<b>Standby Search (Optional)</b>	If the Standby Search is set to On, when the TV is in standby mode, available broadcasts will be searched. If the TV locates any new or missing broadcasts, a menu screen will be displayed, asking you whether or not to execute these changes. Channel list will be updated and changed after this process.

<b>Store Mode</b>	If you are displaying the TV in a store, you can activate this mode. Whilst Store Mode is enabled, some items in the TV menu may not be available.
<b>Power Up Mode</b>	This setting configures the power up mode preference.
<b>Install and Retune Menu Contents</b>	
<b>Automatic Channel Scan (Retune) (If available)</b>	<p><i>Displays automatic tuning options.</i></p> <p><b>Digital Aerial:</b> Searches and stores aerial DVB stations.</p> <p><b>Digital Cable:</b> Searches and stores cable DVB stations.</p> <p><b>Analogue:</b> Searches and stores analogue stations.</p> <p><b>Digital Aerial &amp; Analogue:</b> Searches and stores aerial DVB and analogue stations.</p> <p><b>Digital Cable &amp; Analogue:</b> Searches and stores cable DVB and analogue stations.</p>
<b>Manual Channel Scan</b>	This feature can be used for direct broadcast entry.
<b>Network Channel Scan</b>	Searches for the linked channels in the broadcast system.
<b>Analogue Fine Tune</b>	You can use this setting for fine tuning analogue channels. This feature is not available if no analogue channels are stored.
<b>First Time Installation</b>	Deletes all stored channels and settings, resets TV to factory settings.

## General TV Operation

### Using the Channel List

The TV sorts all stored stations in the Channel List. You can edit this channel list, set favourites or set active stations to be listed by using the Channel List options.

### Configuring Parental Settings

*To prohibit viewing of certain programmes, channels and menus can be locked by using the parental control system.*

To display parental lock menu options, the PIN number should be entered. The factory default PIN number is **0000**. After coding the correct PIN number, parental settings menu will be displayed.

**Menu Lock:** Menu lock setting enables or disables the menu access.

**Maturity Lock:** When set, this option gets the maturity information from the broadcast and if this maturity level is disabled, disables access to the broadcast.

**Child Lock:** When Child Lock is set, the TV can only be controlled by the remote control. In this case the control panel buttons will not work.

**Set PIN:** Defines a new PIN number.

**Note:** *If the Country option is set to France, you can use 4725 as the default code.*

### Electronic Programme Guide (EPG)



Some, but not all channels send information about the current and next programmes. Press the  button to view the EPG menu.

**Red button (Prev Day):** Displays the programmes of previous day.

**Green button (Next day):** Displays the programmes of the next day.

**Yellow button (Zoom):** Expands programme information.

**Blue button (Filter):** Views filtering options.

: Press  button to view Select Genre menu. Using this feature, you can search the programme guide database in accordance with the genre. Info available in the programme guide will be searched and results matching your criteria will be listed.

**(i) INFO:** Displays, in detailed, information on the programme selected.

**Numeric buttons (Jump):** Jumps to the preferred channel directly via numeric buttons.

**OK:** Displays programme options.

**Text (Search):** Displays "**Guide Search**" menu.

 (**Now**): Shows the current programme.

**P+P-** : More event info

**IMPORTANT:** Connect a USB disk to your TV while the TV is switched off. You should then switch on the TV to enable the recording feature.

**Note:** Switching to a different broadcast or source is not available during a recording.

## Programme Options

In **EPG** menu, press the **OK** button to enter the **Event Options** menu.

### Select Channel

In **EPG** menu, using this option, you can switch to the selected channel.

### Set Timer / Delete Timer

After you have selected a programme in the **EPG** menu, press the **OK** button. Select the **Set Timer on Event** option and press the **OK** button. You can set a timer for future programmes. To cancel an already set timer, highlight that programme and press the **OK** button. Then select “**Delete Timer**” option. The timer will be cancelled.

## Software Upgrade

Your TV is capable of finding and updating automatically via the Aerial/Cable/Satellite signal.

### Software upgrade search via user interface

Simply navigate on your main menu. Choose **Settings** and select **Other Settings** menu. In **Other Settings** menu navigate on to the **Software for Upgrade** item and press **OK** button to check for a new software upgrade.

### 3 AM search and upgrade mode

While the TV is connected to an aerial signal. If Automatic scanning in the Upgrade Options menu is enabled, the TV wakes up at 03:00 and searches broadcast channels for new software upgrades. If new software is found and downloaded successfully, the next time the TV powers up, it will have the new software version.

**Note:** If the TV fails to come on after the upgrade unplug the TV for 2 minutes and plug in again.

## Troubleshooting & Tips

### Tv will not turn on

Make sure the power cord is plugged in securely to wall outlet. The batteries in the remote control may be exhausted. Press the Power button on the TV.

### Poor picture

- Have you selected the correct TV system?
- Low signal level can cause picture distortion. Please check antenna access.
- Check if you have entered the correct channel frequency if you have done manual tuning.

- The picture quality may degrade when two devices are connected to the TV at the same time. In such a case, disconnect one of the devices.

### No picture

- No Picture means that your TV is not receiving a transmission. Have you selected the correct button on the remote control? Try once more. Also make sure the correct input source has been selected.
- Is the antenna connected properly?
- Is the antenna cable damaged?
- Are suitable plugs used to connect the antenna?
- If you are in doubt, consult your dealer.

### No sound

- Has the TV been set to mute? To cancel mute, press the “” button, or increase the volume level.
- Sound is coming from only one speaker. Is the balance set to one extreme? See Sound Menu section.

### Remote control - does not operate

- The batteries may be exhausted. Replace the batteries.

### Input sources - can not be selected

- If you cannot select an input source, it is possible that no device is connected. if not
- Check the AV cables and connections if you have tried to connect a device.

## PC Input Typical Display Modes

The following table is an illustration of some of the typical video display modes. Your TV may not support all resolutions. Your TV supports up to 1920x1080.

Index	Resolution	Frequency
1	1024x768	60 Hz
2	1280x768	60 Hz
3	1360x768	60 Hz
4	800x600	56 Hz
5	800x600	60 Hz
6	1024x768	66 Hz
7	1280x960	60 Hz
8	1280x1024	60 Hz
9	1400x1050	60 Hz
10	1600x1200	60 Hz
11	1920x1080	60 Hz

## AV and HDMI Signal Compatibility

Source	Supported Signals	Available	
EXT (SCART)	PAL 50/60	O	
	NTSC 60	O	
	RGB 50	O	
	RGB 60	O	
Side AV	PAL 50/60	O	
	NTSC 60	O	
PC/ YPbPr	480I, 480P	60Hz	O
	576I, 576P	50Hz	O
	720P	50Hz,60Hz	O
	1080I	50Hz,60Hz	O
	1080P	50Hz,60Hz	O
HDMI1	480I	60Hz	O
	480P	60Hz	O
	576I, 576P	50Hz	O
	720P	50Hz,60Hz	O
	1080I	50Hz,60Hz	O
	1080P	24Hz, 25Hz 30Hz, 50Hz, 60Hz	O

(X: Not Available, O: Available)

In some cases a signal on the LED TV may not be displayed properly. The problem may be an inconsistency with standards from the source equipment (DVD, Set-top box, etc. ). If you do experience such a problem please contact your dealer and also the manufacturer of the source equipment.

## Supported File Formats for USB Mode

Media	File Extension	Format		Remarks (Maximum resolution/Bit rate etc.)	
		Video	Audio		
Movie	mpg, mpeg	MPEG1, MPEG2		MPEG1: 768x576 @30P MPEG2:1920x1080 @ 30P	
	vob	MPEG2		1920x1080 @ 30P	
	mp4	MPEG4, Xvid , H.264			
	mkv	H.264, MPEG4,VC-1			
	avi	MPEG2, MPEG4, Xvid , H.264			
	flv	H.264/VP6/Sorenson			H.264/VP6:1920x1080 @ 30P Sorenson: 352x288 @30P
	3gp	MPEG4 , H.264			1920x1080 @ 30P
Music	.mp3	-	MPEG 1 Layer 2	32Kbps ~ 448Kbps(Bit rate) 32K, 44.1k, 48k Hz,16K, 22.05K, 24K Hz (Sampling rate)	
			MPEG 1 Layer 3	32Kbps ~ 320Kbps(Bit rate) 32K, 44.1k, 48k Hz,16K, 22.05K, 24K Hz,8K, 11.025K, 12K Hz (Sampling rate)	
Photo	.jpg .jpeg	Baseline JPEG	-	max WxH = 17000x10000 4147200bytes	
	.	Progressive JPEG	-	max WxH = 4000x4000 3840000bytes	
	.bmp	-	-	max WxH = 5760x4096 3840000bytes	
Subtitle	.sub .srt	-	-	-	

## DVD Mode

### Safety Information

#### CAUTION

DVD Player is a class 1 laser product. This product use a visible laser. This laser could harm when pointed direct to eyes. Be sure to operate the player correctly as instructed.

**CLASS 1  
LASER PRODUCT**

#### RISK OF ELECTRIC SHOCK

The lightning flash with arrowhead symbol, within an equilateral triangle, is intended to alert the user to the presence of uninsulated "dangerous voltage" within the product's enclosure that may be of sufficient magnitude to constitute a risk of electric shock of persons.

The exclamation point within an equilateral triangle is intended to alert the user to the presence of important operating and maintenance (servicing) instructions in the literature accompanying the appliance.

### Notes on Discs

#### On handling discs

- To keep the disc clean, handle the disc by its edge. Do not touch the surface.
- Do not stick paper or tape on the disc.
- If the disc is contaminated with any substance like glue remove before using it.

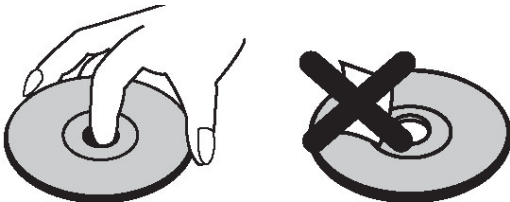

- Do not expose the disc to direct sunlight or heat sources such as hot air ducts, or leave it in a car parked in direct sunlight as the temperature can rise quickly and damage the disc.
- After playing, store the disc in its case.

### On cleaning

- Before playing, clean the disc with a cleaning cloth. Wipe the disc from the center out.

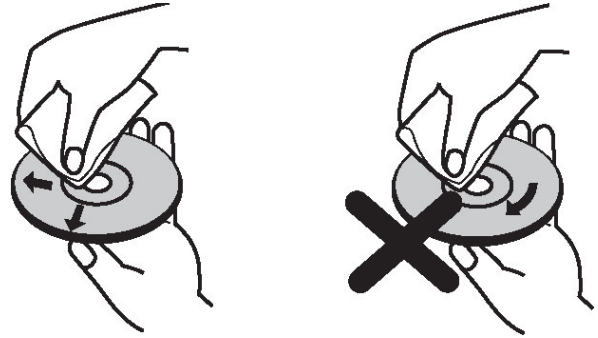

- Do not use solvents such as benzene, thinner, commercially available cleaners or anti-static spray intended for vinyl LPs.

### Licence Notification

- This product incorporates copyright protection technology that is protected by U.S. patents and other intellectual property rights. Use of this copyright protection technology must be authorized by Rovi Corporation, and is intended for home and other limited viewing uses only unless otherwise authorized by Rovi Corporation. Reverse engineering and disassembly are prohibited.

### How to Watch a DVD

When placing a disc into the loader, labeled side of the disc should be on the front:

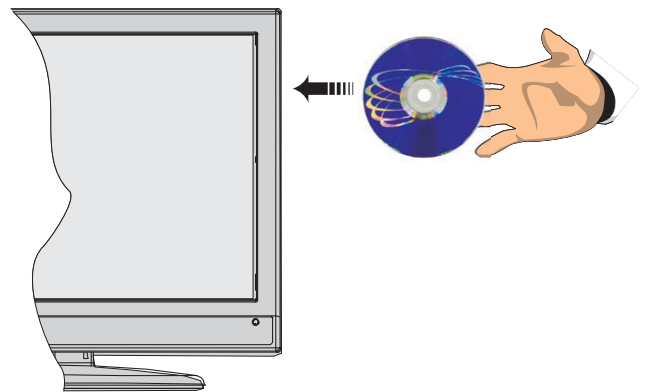

When TV set is turned on, first switch to DVD source by using the **SOURCE** button on the remote control. Press play on the remote control, or directly press play button at the front panel. If there is no disc inside the loader, place a DVD first and press play.

**Note:** If you switch to another source by pressing **SOURCE**, **SWAP** or **P+/P-** buttons on the remote control, DVD playback will be paused automatically. You should press **PLAY** and resume the playback manually when you switch to DVD mode.

## DVD Control Panel Buttons

### A. Disc loader

### B. Play / Pause

Plays/pauses the disc. When DVD menu (root menu) is active, this button functions as "button select" (selects the highlighted item in menu) if this is not prohibited by the disc.

### C. Stop / Eject

Stop playing disc / Eject or Load the disc Note:

- You cannot eject the disc via the remote control.
- While playing a file, you should press STOP button three times to eject.

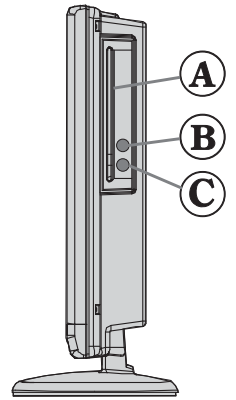



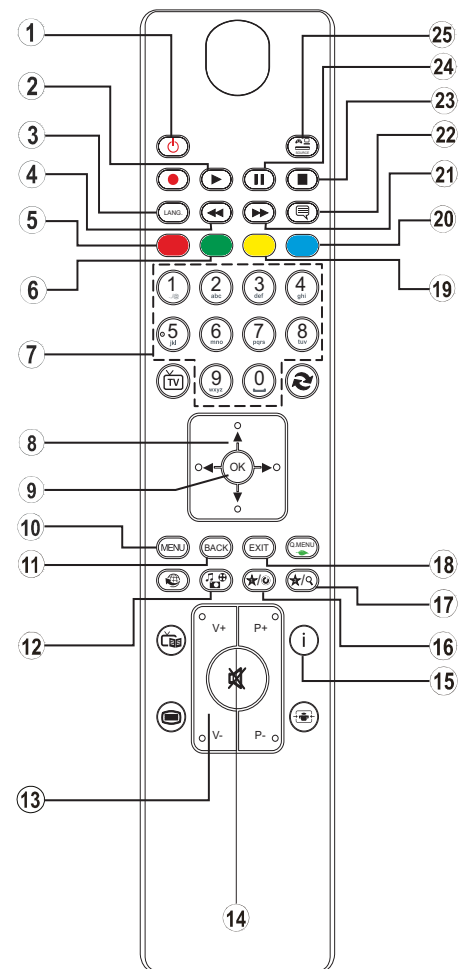



1. Standby
2. Play
3. Language selection (Set language)
4. Rapid reverse
5. Zoom
6. Repeat
7. Numeric buttons
8. Navigation buttons
9. OK
10. Menu
11. Return
12. Angle
13. volume up / down
14. Mute
15. Info
16. My button 1 / Display time / DVD menu
17. My button 2 / Search mode
18. Exit
19. Root
20. Title
21. Rapid advance
22. Subtitle
23. Stop
24. Pause
25. AV / Source selection









## General Operation

You can operate DVD, movie CD, music or picture CD's content by using the proper buttons on your remote control. Below are main functions of commonly used remote control buttons.

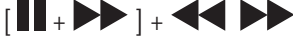
Buttons on the Remote Control	DVD Playback	Movie Playback	Picture Playback	Music Playback
	Play	Play	Play	Play
	Pause	Pause	Pause	Pause
	Stop	Stop	Stop	Stop
	Skip backward/ forward	Skip backward/ forward	Rotate	Skip backward/forward
	Highlights a menu item / Shifts the zoomed picture up or down (if available).			
	Fast reverse / Fast forward			
	Views the scene from different angles (if available)		Changes slide effect (depends on the content)	X
<b>MY BUTTON1</b>	Displays time / Views main setup menu			
<b>INFO</b>	Time counter mode selection (during playback). Press repeatedly to switch between modes.			
<b>LANG.</b>	Audio language.		X	X
<b>MENU</b>	Displays TV menu.			
<b>OK / SELECT</b>	Enter / View / Play			
<b>GREEN</b>	Displays repeat options.			
<b>RETURN</b>	Returns back to the previous menu (if available).			
<b>YELLOW</b>	Goes back to the root folder (if available).			
<b>MY BUTTON2</b>	Direct selection of scenes or time.		Selects the desired file.	Selects the desired file.
<b>SUBTITLE</b>	Subtitle on-off. Press repeatedly to switch between subtitle options.		X	X
<b>SWAP</b>	Media source selection.			
<b>BLUE</b>	Displays disc menu (if available).	Displays disc menu (if available).	X	X
<b>RED</b>	Zooms picture. Press repeatedly to switch between zoom options.			

### Other Functions – Button Combinations (During playback)

	Slow forward.
	Sets slow forward speed.
	Sets fast forward speed.
	Sets fast reverse speed.
	Confirms stop command.

(\*) You can switch to title by pressing numeric keys directly. You need to press 0 and then digit key to switch one digit titles (example: to select 5, press 0 and 5).

## General Playback

### Basic Play

1. Press on the power button
2. Please insert a disc to the loader.

The disc will be automatically loaded and play commences if the disc does not have any menus recorded on it.

A menu may appear on the TV screen after a few moments or the film may start immediately after the introduction of the Film Company. This behaviour depends on the disc content and may change.

**Note:** Step 3 and 4 is available only when a menu is recorded on the disc.

3. Press “▼” / “▲” / ◀ / ▶ or the number button (s) to select the preferred title.
4. Press OK.

Play of the selected items now starts. The played item may be a motion picture, a still picture or another submenu depending on the disc.

### For your reference:

If an action corresponding to a button is prohibited the “” symbol appears.

### Notes on Playback:

1. No sound will be heard during Rapid advance or Rapid reverse.
2. No sound will be heard during Slow motion play.
3. Reverse slow motion play is not available.
4. In some cases, the subtitle language is not changed immediately to the selected one.
5. When the preferred language is not selected even after pressing the button several times, it means that the language is not available on the disc.
6. When the player is restarted or the disc is changed, the subtitle selection is automatically changed back to the initial settings.
7. If a language is selected, not supported by the disc, the subtitle language will automatically be set to the disc's priority language.
8. Usually a circulation will happen while switching to another language, that is you can cancel the subtitle by pressing this button a number of times until “Subtitle Off” appears on the screen.
9. When the power is turned on or the disc is removed, the language heard is the one selected at the initial settings. If this language is not recorded on the disc, only the available language on the disc will be heard.
10. Some DVDs may not contain root and/or title menus.
11. Reverse stepping is not available.
12. For your convenience:

If you attempt to enter a number greater than the total time of the current title, the time search box disappears

and “ Input Invalid” message appears on up-left corner of screen.

13. Slide Show is disabled when the ZOOM mode is on.

## DVD Troubleshooting

### The picture quality is poor (DVD)

- Make sure the DVD disc surface is not damaged. (Scratch, fingerprint etc.)
- Clean the DVD disc and try again.

*See instructions described in “Notes on Discs” to clean your disc properly.*

- Ensure that the DVD disc is in the drawer with the label uppermost.
- A damp DVD disc or condensation may effect the equipment. Wait for 1 to 2 hours in Stand-by to dry the equipment.

### Disc does not play

- No disc in the machine. *Place a disc into the loader.*
- Disc incorrectly loaded.

*Ensure that the DVD disc is in the drawer with the label uppermost.*

- Wrong type of disc. The machine cannot play CD-ROMS etc. • The region code of the DVD must match the player.

### Wrong OSD language

- Select the language in the set-up menu.
- The language for the sound or subtitles on a DVD cannot be changed.
- Multilingual sound and/or subtitles not recorded on the DVD.
- Try to change the sound or subtitles using DVD's title menu. Some DVD's do not allow the user to change these settings without using the disc's menu
- These functions are not available on the DVD.

### No picture

- Have you pressed the correct buttons on the remote control? Try once more.

### No sound

- Check the volume is set to an audible level.
- Make sure you have not switched the sound off accidentally.





### Distorted sound

- Check that the appropriate listening mode setting is correct.

### If nothing works

If you have tried the above solutions and none seem to work, try switching your TV-DVD off and on again. If this does not work, contact your supplier or TV-DVD repair technician. Never attempt to repair a defective TV-DVD yourself.

## Disc Types Compatible with This Unit

Disc Types (Logos)	Recording Types	Disc Size	Max. Playing Time	Characteristics
	Audio + Video	12 cm	Single-sided; 240 min. Double-sided; 480 min.	<ul style="list-style-type: none"> <li>DVD contains excellent sound and video due to Dolby Digital and MPEG-2 System.</li> <li>Various screen and audio functions can be easily selected through the on screen menu.</li> </ul>
	Audio	12 cm	74 min.	<ul style="list-style-type: none"> <li>An LP is recorded as an analog signal with more distortion. CD is recorded as a Digital Signal with better audio quality, less distortion and less deterioration of audio quality over time.</li> </ul>
	Audio (xxxx.mp3)	12 cm	It depends on MP3 quality.	<ul style="list-style-type: none"> <li>MP3 is recorded as a Digital Signal with better audio quality, less distortion and less deterioration of audio quality over time.</li> </ul>
	Video (still picture)	12 cm	It depends on JPEG quality.	<ul style="list-style-type: none"> <li>JPEG is recorded as a Digital Signal with better picture quality over time.</li> </ul>

For proper operation, only 12 cm discs must be used.

## Specifications

Types of Discs Supported	<b>DVD:</b> SS/SL 4.7" (DVD-5) SS/DL 4.7" (DVD-9) DS/SL 4.7" (DVD-10) DS/DL 4.7" (DVD-18)	CD-DA CD-R CD-RW MP-3/JPEG
Video Type	MPEG-2 Video Standard Decoding (MPEG-1 supported) Full-Screen Video Display of 720 x 576 (PAL) & 720 x 480 (NTSC) pixels 50 and 60 Hz frame refresh rates (PAL & NTSC) Digital bit-stream processing rate up to 108Mbits/sec Line resolution more than 500 lines	
Audio Type	MPEG Multichannel Decoding LPCM	
Audio Output	<b>Analog Outputs:</b> 24 bit /48, 44.1kHz down-sampling DAC	