

LCD Digital Colour TV



Operating Instructions

- ⚠ Before operating the TV, please read the "Safety information" section of this manual.
Retain this manual for future reference.

KDL-46T35xx
KDL-40T35xx
KDL-40V29xx



BRAVIA



For useful information about Sony products

<http://www.sony-europe.com/myproduct/>

NOTICE FOR CUSTOMERS IN THE UNITED KINGDOM

A moulded plug complying with BS1363 is fitted to this equipment for your safety and convenience. Should the fuse in the plug supplied need to be replaced with the same rating of fuse approved by ASTA or BSI to BS 1362 (i.e., marked with  or ) must be used. When an alternative type of plug is used it should be fitted with the same rating of fuse, otherwise the circuit should be protected by a 13 AMP FUSE at the distribution board. If the plug supplied with this equipment has a detachable fuse cover, be sure to attach the fuse cover after you change the fuse. Never use the plug without the fuse cover. If you should lose the fuse cover, please contact your nearest Sony service station.

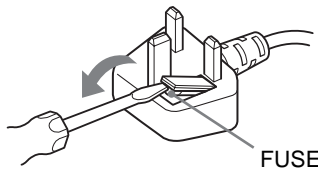

How to replace the fuse

Open the fuse compartment with a blade screwdriver, and replace the fuse.

Disposal of the TV set



Disposal of Old Electrical & Electronic Equipment (Applicable in the European Union and other European countries with separate collection systems)

This symbol on the product or on its packaging indicates that this product shall not be treated as household waste. Instead it shall be handed over to the applicable collection point for the recycling

of electrical and electronic equipment. By ensuring this product is disposed of correctly, you will help prevent potential negative consequences for the environment and human health, which could otherwise be caused by inappropriate waste handling of this product. The recycling of materials will help to conserve natural resources. For more detailed information about recycling of this product, please contact your local Civic Office, your household waste disposal service or the shop where you purchased the product.

The manufacturer of this product is Sony Corporation, 1-7-1 Konan Minato-ku Tokyo, 108-0075 Japan. The Authorized Representative for EMC and product safety is Sony Deutschland GmbH, Hedelfinger Strasse 61, 70327 Stuttgart, Germany. For any service or guarantee matters please refer to the addresses given in separate service or guarantee documents.

Introduction

Thank you for choosing this Sony product. Before operating the TV, please read this manual thoroughly and retain it for future reference.

Notice for Digital TV function

- Any functions related to Digital TV (**DVB**) will only work in countries or areas where DVB-T (MPEG2) digital terrestrial signals are broadcasted. Please confirm with your local dealer if you can receive a DVB-T signal where you live.
- Although this TV set follows DVB-T specifications, compatibility with future DVB-T digital terrestrial broadcasts cannot be guaranteed.
- Some Digital TV functions may not be available in some countries.

Trademark information

- **DVB** is a registered trademark of the DVB Project
- Manufactured under license from BBE Sound, Inc. Licensed by BBE Sound, Inc. under one or more of the following US patents: 5510752, 5736897. BBE and BBE symbol are registered trademarks of BBE Sound, Inc.
- TruSurround XT, SRS and  symbol are trademarks of SRS Labs, Inc. TruSurround XT technology is incorporated under license from SRS Labs, Inc.
- HDMI, the HDMI logo and High-Definition Multimedia Interface are trademarks or registered trademarks of HDMI Licensing LLC.

BBE
DIGITAL®

SRS®
TruSurround XT

HDMI™
HIGH-DEFINITION MULTIMEDIA INTERFACE

- The illustrations used in this manual are of the KDL-40T35xx unless otherwise stated.
- The "xx" that appears on the model name, corresponds to two numeric digits related to colour variation.

Table of Contents

Start-up Guide

4

Safety information	8
Precautions	9
Overview of the remote	10
Overview of the TV buttons and indicators	11

Watching TV

Watching TV	12
Checking the Digital Electronic Programme Guide (EPG) DVB	15
Using the Favourite list DVB	17
Viewing pictures from connected equipment	18

Using MENU Functions

Navigating through menus	19
Picture menu	20
Sound menu	22
Screen menu	24
Set-up menu	25
PC Settings menu	28
Analogue Set-up menu (Analogue mode only)	29
Digital Set-up menu DVB	32

Using Optional Equipment

Connecting optional equipment.....	34
------------------------------------	----

Additional Information

Specifications	37
Troubleshooting	39

DVB : for digital channels only

Start-up Guide

1: Checking the accessories

Remote RM-ED008 (1)

Size AA batteries (R6 type) (2)

Mains lead (Type BF) (1)

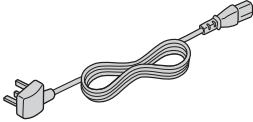

Coaxial cable (1)



Cable holder (1)

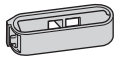

Support belt (1) and screws (2)

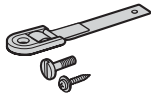

To insert batteries into the remote

Push and slide to open.

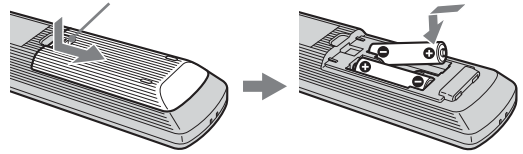

Notes

- Observe the correct polarity when inserting batteries.
- Do not use different types of batteries together or mix old and new batteries.
- Dispose of batteries in an environmentally friendly way. Certain regions may regulate disposal of the battery. Please consult your local authority.
- Handle the remote control with care. Do not drop or step on it, or spill liquid of any kind onto it.
- Do not place the remote control in a location near a heat source, or in a place subject to direct sunlight, or in a damp room.

2: Connecting an aerial/VCR

Connecting an aerial only

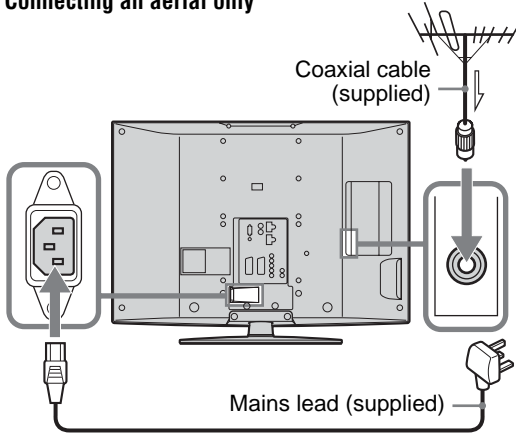

Connecting an aerial and VCR

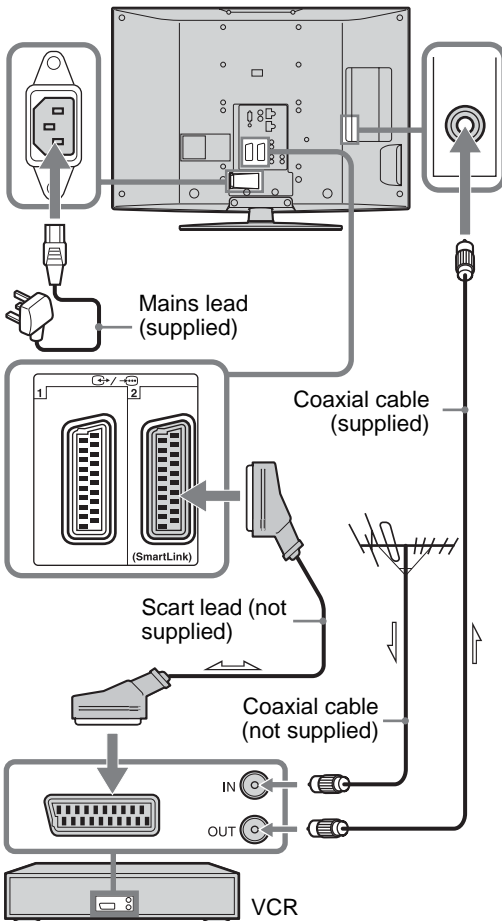

3: Preventing the TV from toppling over

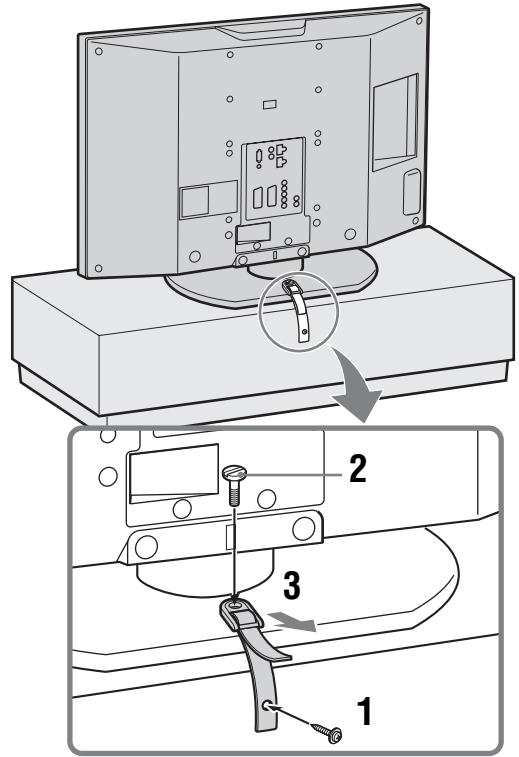

4: Bundling the cables

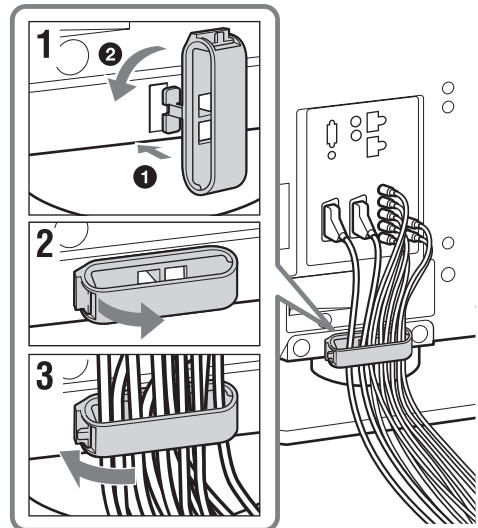

Continued

5: Selecting the language and country/region

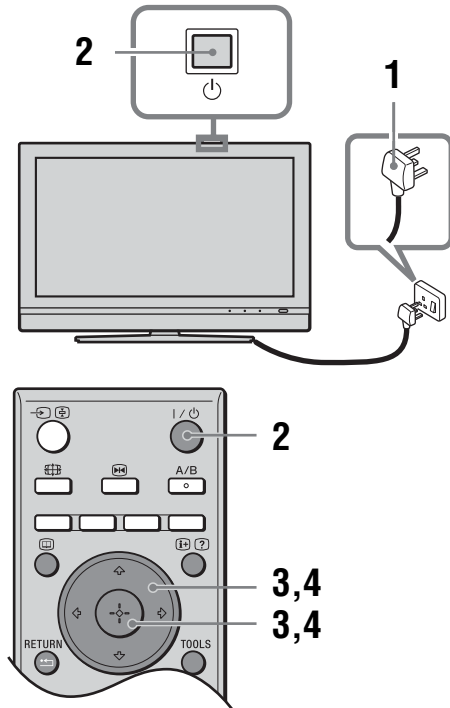

- 1** Connect the TV to your mains socket (220-240V AC, 50Hz).
- 2** Press on the TV (top side).
When you switch on the TV for the first time, the Language menu appears on the screen.
When the TV is in standby mode (the (standby) indicator on the TV (front) is red), press on the remote to switch on the TV.

- 3** Press to select the language displayed on the menu screens, then press .

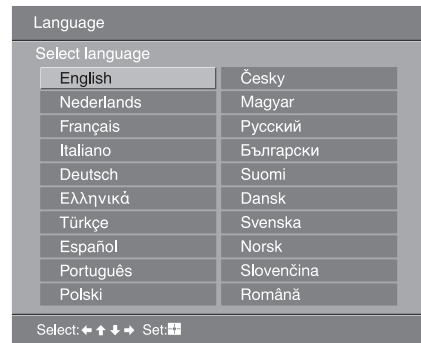

- 4** Press to select the country/region in which you will operate the TV, then press .

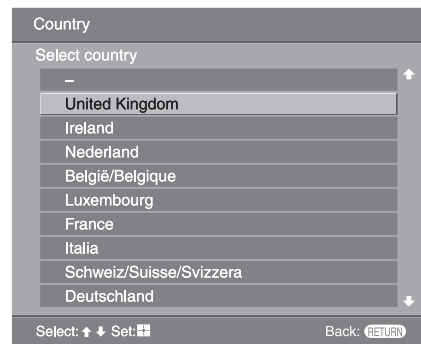

If the country/region in which you want to use the TV does not appear in the list, select “-” instead of a country/region.
The message confirming the TV start auto-tuning appears on the screen, then go to “6: Auto-tuning the TV”.

6: Auto-tuning the TV

The TV will now search for and store all available TV channels.

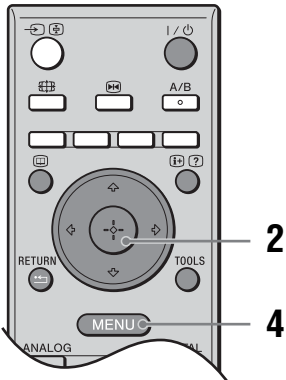

- 1 Before you start auto-tuning the TV, insert a pre-recorded tape into the VCR connected to the TV (page 5) and start play back.

The video channel will be located and stored on the TV during auto-tuning.
If no VCR is connected to the TV, this procedure is not required. Go to step 2.

- 2 Press \leftarrow/\rightarrow to select "OK", then press \oplus .

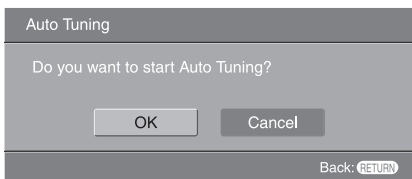

The TV starts searching for all available digital channels, followed by all available analogue channels. This may take some time, please be patient and do not press any buttons on the TV or remote.

If a message appears for you to confirm the aerial connections

No digital or analogue channels were found.
Check all the aerial connections and press \oplus to start auto-tuning again.

- 3 When the Programme Sorting menu appears on the screen, follow the steps of "Programme Sorting" (page 29).

If you do not change the order in which the analogue channels are stored on the TV, go to step 4.

- 4 Press MENU to exit.

The TV has now tuned in all the available channels.

Note

When a digital broadcast channel cannot be received, or when selecting a region in which there are no digital broadcasts in step 4 under "5: Selecting the language and country/region", the time must be set from "Clock Set" in the "Set-up" menu (page 26) after performing step 4.

Safety information

Installation/Set-up

Install and use the TV set in accordance with the instructions below in order to avoid any risk of fire, electrical shock or damage and/or injuries.

Installation

- The TV set should be installed near an easily accessible mains socket.
- Place the TV set on a stable, level surface.
- Only qualified service personnel should carry out wall installations.
- For safety reasons, it is strongly recommended that you use Sony accessories, including:
 - Wall-mount bracket SU-WL51.

Transporting

- Before transporting the TV set, disconnect all cables.
- Two or three people are needed to transport a large TV set.
- When transporting the TV set by hand, hold it as shown on the right. Do not put stress on the LCD panel and the frame around the screen.
- When lifting or moving the TV set, hold it firmly from the bottom.
- When transporting the TV set, do not subject it to jolts or excessive vibration.
- When transporting the TV set for repairs or when moving, pack it using the original carton and packing material.

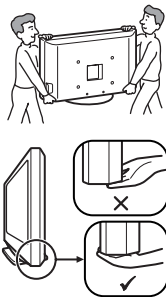

Installed with stand

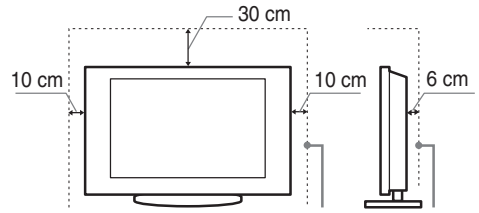

Leave at least this space around the set.

- To ensure proper ventilation and prevent the collection of dirt or dust:
 - Do not lay the TV set flat, install upside down, backwards, or sideways.
 - Do not place the TV set on a shelf, rug, bed or in a closet.
 - Do not cover the TV set with a cloth, such as curtains, or items such as newspapers, etc.
 - Do not install the TV set as shown below.

Air circulation is blocked.

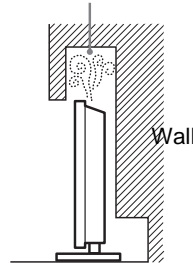

Air circulation is blocked.

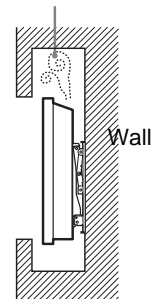

Ventilation

- Never cover the ventilation holes or insert anything in the cabinet.
- Leave space around the TV set as shown below.
- It is strongly recommended that you use a Sony wall-mount bracket in order to provide adequate air-circulation.

Installed on the wall

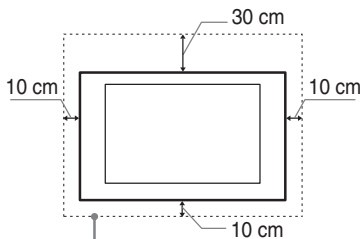

Leave at least this space around the set.

Mains lead

Handle the mains lead and socket as follows in order to avoid any risk of fire, electrical shock or damage and/or injuries:

- Connect the TV set using a three-wire grounding type mains plug to a mains socket with a protective earthing connection.
- Use only Sony mains leads, not those of other brands.
- Insert the plug fully into the mains socket.
- Operate the TV set on a 220-240 V AC supply only.
- When wiring cables, be sure to unplug the mains lead for your safety and take care not to catch your feet on the cables.
- Disconnect the mains lead from the mains socket before working on or moving the TV set.
- Keep the mains lead away from heat sources.
- Unplug the mains plug and clean it regularly. If the plug is covered with dust and it picks up moisture, its insulation may deteriorate, which could result in a fire.

Notes

- Do not use the supplied mains lead on any other equipment.
- Do not pinch, bend, or twist the mains lead excessively. The core conductors may be exposed or broken.
- Do not modify the mains lead.
- Do not put anything heavy on the mains lead.

- Do not pull on the mains lead itself when disconnecting the mains lead.
- Do not connect too many appliances to the same mains socket.
- Do not use a poor fitting mains socket.

Prohibited Usage

Do not install/use the TV set in locations, environments or situations such as those listed below, or the TV set may malfunction and cause a fire, electrical shock, damage and/or injuries.

Location:

Outdoors (in direct sunlight), at the seashore, on a ship or other vessel, inside a vehicle, in medical institutions, unstable locations, near water, rain, moisture or smoke.

Environment:

Places that are hot, humid, or excessively dusty; where insects may enter; where it might be exposed to mechanical vibration, near flammable objects (candles, etc).

The TV set shall not be exposed to dripping or splashing and no objects filled with liquids, such as vases, shall be placed on the TV.

Situation:

Do not use when your hands are wet, with the cabinet removed, or with attachments not recommended by the manufacturer. Disconnect the TV set from mains socket and aerial during lightning storms.

Broken pieces:

- Do not throw anything at the TV set. The screen glass may break by the impact and cause serious injury.
- If the surface of the TV set cracks, do not touch it until you have unplugged the mains lead. Otherwise electric shock may result.

When not in use

- If you will not be using the TV set for several days, the TV set should be disconnected from the mains for environmental and safety reasons.
- As the TV set is not disconnected from the mains when the TV set is just turned off, pull the plug from the mains to disconnect the TV set completely.
- However, some TV sets may have features that require the TV set to be left in standby to work correctly.

For children

- Do not allow children to climb on the TV set.
- Keep small accessories out of the reach of children, so that they are not mistakenly swallowed.

If the following problems occur...

Turn off the TV set and unplug the mains lead immediately if any of the following problems occur. Ask your dealer or Sony service centre to have it checked by qualified service personnel.

When:

- Mains lead is damaged.
- Poor fitting of mains socket.
- TV set is damaged by being dropped, hit or having something thrown at it.

- Any liquid or solid object falls through openings in the cabinet.

Precautions

Viewing the TV

- View the TV in moderate light, as viewing the TV in poor light or during long period of time, strains your eyes.
- When using headphones, adjust the volume so as to avoid excessive levels, as hearing damage may result.

LCD Screen

- Although the LCD screen is made with high-precision technology and 99.99% or more of the pixels are effective, black dots may appear or bright points of light (red, blue, or green) may appear constantly on the LCD screen. This is a structural property of the LCD screen and is not a malfunction.
- Do not push or scratch the front filter, or place objects on top of this TV set. The image may be uneven or the LCD screen may be damaged.
- If this TV set is used in a cold place, a smear may occur in the picture or the picture may become dark. This does not indicate a failure. These phenomena disappear as the temperature rises.
- Ghosting may occur when still pictures are displayed continuously. It may disappear after a few moments.
- The screen and cabinet get warm when this TV set is in use. This is not a malfunction.
- The LCD screen contains a small amount of liquid crystal and mercury. The fluorescent tubes used in this TV set also contain mercury. Follow your local ordinances and regulations for disposal.

Handling and cleaning the screen surface/cabinet of the TV set

Be sure to unplug the mains lead connected to the TV set from mains socket before cleaning.

To avoid material degradation or screen coating degradation, observe the following precautions.

- To remove dust from the screen surface/cabinet, wipe gently with a soft cloth. If dust is persistent, wipe with a soft cloth slightly moistened with a diluted mild detergent solution.
- Never use any type of abrasive pad, alkaline/acid cleaner, scouring powder, or volatile solvent, such as alcohol, benzene, thinner or insecticide. Using such materials or maintaining prolonged contact with rubber or vinyl materials may result in damage to the screen surface and cabinet material.
- When adjusting the angle of the TV set, move it slowly so as to prevent the TV set from moving or slipping off from its table stand

Optional Equipment

Keep optional components or any equipment emitting electromagnetic radiation away from the TV set. Otherwise picture distortion and/or noisy sound may occur.

Overview of the remote

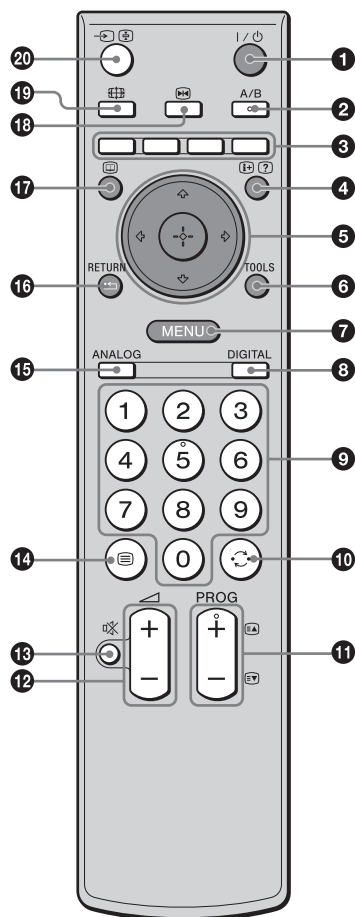

- 1 I/⏻ – TV standby**
Switches the TV on and off from standby mode.
- 2 A/B – Dual Sound (page 23)**
- 3 Coloured buttons**
 - In digital mode (page 15, 17): Selects the options at the bottom of the Favourite and EPG digital menus.
 - In Analogue Text mode (page 13): Used for Fastext.
- 4 ⏻/? – Info / Text reveal**
 - In digital mode: Displays brief details of the programme currently being watched.
 - In analogue mode: Displays information such as current channel number and screen format.
 - In Analogue Text mode: Reveals hidden information (e.g., answers to a quiz).
- 5 ⏻/⏪/⏩/⏹/⏺ (page 12, 19)**
- 6 TOOLS (page 14, 18, 36)**
Enables you to access various viewing options and change/make adjustments according to the source and screen format.
- 7 MENU (page 19)**
- 8 DIGITAL – Digital mode (page 12)**
- 9 Number buttons**
 - In TV mode: Selects channels. For channel numbers 10 and above, enter the second or third digit within two seconds.
 - In Analogue Text mode: Enters the three digit page number to select the page.
- 10 ↻ – Previous channel**
Returns to the previous channel watched (for more than five seconds).
- 11 PROG +/- (page 12)**
 - In TV mode: Selects the next (+) or previous (-) channel.
 - In Analogue Text mode: Selects the next (+) or previous (-) page.
- 12 🔊 +/- – Volume**
- 13 🔊 – Mute (page 12)**
- 14 ☰ – Text (page 13)**
- 15 ANALOG – Analogue mode (page 12)**
- 16 ⏪ / RETURN**
Returns to the previous screen of any displayed menu.
- 17 📖 – EPG (Digital Electronic Programme Guide) (page 15)**
- 18 📺 – Picture freeze (page 13)**
Freezes the TV picture.
- 19 📺 – Screen mode (page 13)**
Changes the screen format when repeatedly pressed (displays the current screen format when pressed only once).
- 20 ⏪/⏹ – Input select / Text hold**
 - In TV mode (page 18): Selects the input source from equipment connected to the TV sockets.
 - In Analogue Text mode: Holds the current page.

Tip

The A/B, PROG + and number 5 buttons have tactile dots. Use the tactile dots as references when operating the TV.

Overview of the TV buttons and indicators

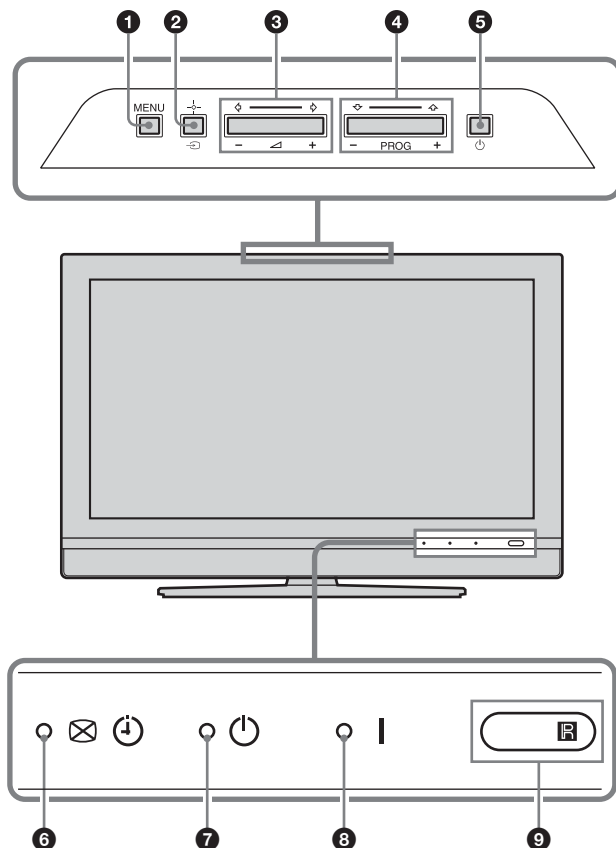

1 MENU (page 19)

2 →/++ – Input select/OK

- In TV mode (page 18): Selects the input source from equipment connected to the TV sockets.
- In TV menu: Selects the menu or option, and confirm the setting.

3 ▲ +/-/◀/▶

- Increases (+) or decreases (-) the volume.
- In TV menu: Moves through the options left (◀) or right (▶).

4 PROG +/-/▲/▼

- In TV mode: Selects the next (+) or previous (-) channel.
- In TV menu: Moves through the options up (▲) or down (▼).

5 ⏻ – Power

Switches the TV on or off.

6 ⏸ ⏰ – Timer REC programme/Picture Off/Timer indicator

- Lights up in orange when the Timer recording is set (page 15, 16).
- Lights up in green when the picture is switched off (page 26).
- Lights up in orange when the timer is set (page 25).

7 ⏻ – Standby indicator

Lights up in red when the TV is in standby mode.

8 | – Power indicator

Lights up in green when the TV is switched on.

9 Remote control sensor/Light sensor (page 26)

- Receives IR signals from the remote.
- Do not put anything over the sensor, as its function may be affected.

Note

Make sure that the TV is completely switched off before unplugging the mains lead. Unplugging the mains lead while the TV is turned on may cause the indicator to remain lit or may cause the TV to malfunction.

Watching TV

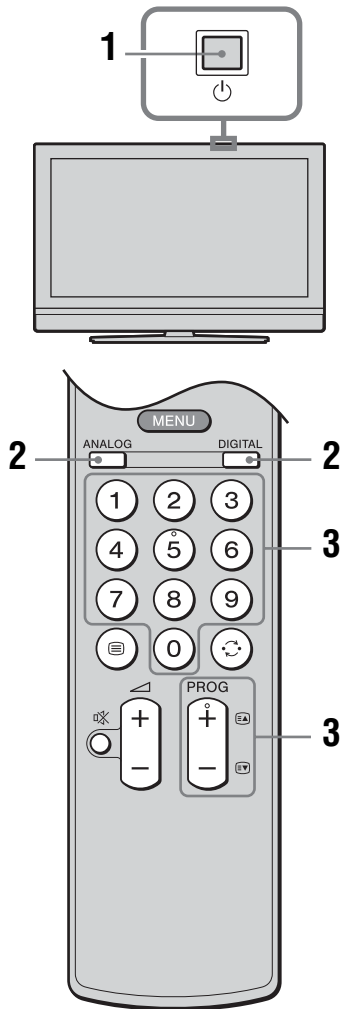

1 Press on the TV (top side) to switch on the TV.

When the TV is in standby mode (the (standby) indicator on the TV (front) is red), press on the remote to switch on the TV.

2 Press DIGITAL to switch to digital mode or ANALOG to switch to analogue mode.

The channels available vary depending on the mode.

3 Press the number buttons or PROG +/- to select a TV channel.

To select channel numbers 10 and above using the number buttons, enter the second and third digits within two seconds.

To select a digital channel using the Digital Electronic Programme Guide (EPG), see page 15.

In digital mode

An information banner appears briefly. The following icons may be indicated on the banner.

- : Interactive service is available (Digital Text)
- : Radio service
- : Scrambled/Subscription service
- : Multiple audio languages available
- : Subtitles available
- : Subtitles available for the hearing impaired
- : Recommended minimum age for current programme (from 4 to 18 years)
- : Parental Lock
- : Current programme is being recorded

Additional operations

To	Do this
Turn off the TV temporarily (Standby mode)	Press .
Turn on the TV from Standby mode without sound	Press . Press +/- to set the volume level.
Turn off the TV	Press on the TV (top side). Note To disconnect the TV completely, pull the plug from the mains.
Adjust the volume	Press + (increase)/ - (decrease).
Mute the sound	Press . Press again to restore.
Access the Programme index table (in analogue mode only)	Press . To select an analogue channel, press , then press . To access the Input signal index table, see page 18.

To access Digital Text

Many broadcasters provide a Digital Text service. Digital Text offers graphically rich contents, compared to Analogue Text. Select a digital channel which provides Digital Text, then press . When a broadcaster provides a dedicated Digital Text channel, select this channel to access Digital Text. To navigate through Digital Text, follow the instructions on the screen. To exit Digital Text, press RETURN. To move around, press ///. To select items, press and the number buttons. To access shortcuts, press the coloured buttons.

To access Analogue Text

In analogue mode, press . Each time you press , the display changes cyclically as follows: Text → Text over the TV picture (mix mode) → No Text (exit the Text service). To select a page, press the number buttons or PROG +/- . To hold a page, press /. To reveal hidden information, press /.

Tips

- Ensure that the TV is receiving a good signal, or some text errors may occur.
- Most TV channels broadcast a Text service. For information on the use of the service, select the index page.
- When four coloured items appear at the bottom of the Text page, Fastext is available. Fastext allows you to access pages quickly and easily. Press the corresponding coloured button to access the page.

To freeze the picture

Freezes the TV picture (e.g. to make a note of a telephone number or recipe).

1 Press .

The frozen picture is displayed on the left of the screen. You can watch a moving picture on the right.

2 Press again to return to normal TV mode.

Note

This function is not available for a PC input source.

To change the screen format manually to suit the broadcast

Press repeatedly to select Smart, 4:3, Wide, Zoom, or 14:9.

Smart*

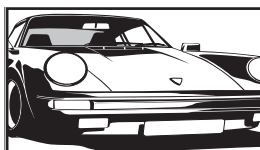

Displays conventional 4:3 broadcasts with an imitation wide screen effect. The 4:3 picture is stretched to fill the screen.

4:3

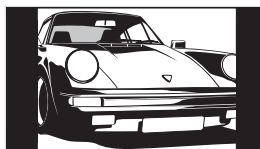

Displays conventional 4:3 broadcasts (e.g., non-wide screen TV) in the correct proportions.

Wide

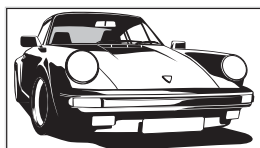

Displays wide screen (16:9) broadcasts in the correct proportions.

Zoom*

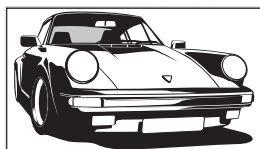

Displays cinematographic (letter box format) broadcasts in the correct proportions.

14:9*

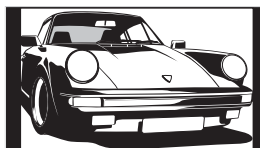

Displays 14:9 broadcasts in the correct proportions. As a result, black border areas are visible on the screen.

* Parts of the top and bottom of the picture may be cut off.

Tips

- Alternatively, you can set "Auto Format" to "On". The TV will automatically select the best mode to suit the broadcast (page 24).
- You can adjust the position of the picture when selecting Smart (50 Hz), Zoom or 14:9. Press / to move up or down (e.g., to read subtitles).
- Some characters and/or letters at the top and the bottom of the picture may not be visible in Smart mode. In such a case, you can select "Vertical Size" using the "Screen" menu and adjust vertical size to make it visible.
- Select "Smart" or "Zoom" to adjust for 720p or 1080i source pictures with edge portions cut off.

Continued

Using the Tools menu

Press TOOLS to display the following options when viewing the TV programme.

Options	Description
Close	Closes the Tools menu.
Power Saving	See page 26.
Subtitle Setting (in digital mode only)	See page 33.
Digital Favourites (in digital mode only)	See page 17.
Picture Mode	See page 20.
Sound Mode	See page 22.
Auto Clock Set (in analogue mode only)	Allows you to switch to digital mode and obtain the time.
Sleep Timer	See page 25.
 Volume	Adjusts the volume of the headphones.

Checking the Digital Electronic Programme Guide (EPG) DV3*



Digital Electronic Programme Guide (EPG)

* This function may not be available in some countries.

























- 1 In digital mode, press to display the Digital Electronic Programme Guide (EPG).
- 2 Perform the desired operation, as shown in the following table.

Note

Programme information will only be displayed if the TV station is transmitting it.

To	Do this
Turn off the EPG	Press .
Move through the EPG	Press , , , .
Watch a current programme	Press while the current programme is selected.
Sort the programme information by category – Category list	<ol style="list-style-type: none"> 1 Press the blue button. 2 Press , , , to select a category. The category name is displayed on the side. The categories available include: “All Categories”: Contains all available channels. Category name (e.g. “News”): Contains all channels corresponding to the selected category. 3 Press . <p>The Digital Electronic Programme Guide (EPG) now only displays the current programmes from the category selected.</p>
Set a programme to be recorded – Timer REC	<ol style="list-style-type: none"> 1 Press , , , to select the future programme you want to record. 2 Press . 3 Press , to select “Timer REC”. 4 Press to set the TV and your VCR timers. A symbol appears by that programme’s information. The indicator on the TV (front) lights up in orange.
<h3>Notes</h3> <ul style="list-style-type: none"> • You can set VCR timer recording on the TV only for Smartlink compatible VCRs. If your VCR is not Smartlink compatible, a message will be displayed to remind you to set your VCR timer. • Once a recording has begun, you can switch the TV to standby mode, but do not switch off the TV completely or the recording may be cancelled. • If an age restriction for programmes has been selected, a message asking for pin code will appear on the screen. For more details refer to “Parental Lock” on page 33. 	

Continued

To	Do this
Set a programme to be displayed automatically on the screen when it starts – Reminder	<ol style="list-style-type: none"> 1 Press  to select the future programme you want to display. 2 Press . 3 Press  to select “Reminder”. 4 Press  to automatically display the selected programme when the programme starts. A  symbol appears by that programme’s information.
<p>Note If you switch the TV to standby mode, it will automatically turn itself on when the programme is about to start.</p>	
Set the time and date of a programme you want to record – Manual timer REC	<ol style="list-style-type: none"> 1 Press . 2 Press  to select “Manual timer REC”, then press . 3 Press  to select the date, then press . 4 Set the start and stop time in the same way as in step 3. 5 Press  to select the programme, then press . 6 Press  to set the TV and your VCR timers. A  symbol appears by that programme’s information. The  indicator on the TV (front) lights up in orange.
<p>Notes</p> <ul style="list-style-type: none"> • You can set VCR timer recording on the TV only for Smartlink compatible VCRs. If your VCR is not Smartlink compatible, a message will be displayed to remind you to set your VCR timer. • Once a recording has begun, you can switch the TV to standby mode, but do not switch off the TV completely or the recording may be cancelled. • If an age restriction for programmes has been selected, a message asking for pin code will appear on the screen. For more details refer to “Parental Lock” on page 33. 	
Cancel a recording/reminder – Timer list	<ol style="list-style-type: none"> 1 Press . 2 Press  to select “Timer list”, then press . 3 Press  to select the programme you want to cancel, then press . 4 Press  to select “Cancel Timer”, then press  A display appears to confirm that you want to cancel the programme. 5 Press  to select “Yes”, then press  to confirm.

Tip

You can also display the Digital Electronic Programme Guide (EPG) by selecting “Digital EPG” in the “MENU” (page 19).

Using the Favourite list DV3*



The Favourite feature allows you to select programmes from a list of up to 20 channels you specify. To display the Favourite list, see “Navigating through menus” (page 19).

Favourite list

* This function may not be available in some countries.

To	Do this
Create your Favourite list for the first time	<p>A message appears asking if you want to add channels to the Favourite list when you select “Digital Favourites” in the “MENU” for the first time.</p> <ol style="list-style-type: none"> 1 Press + to select “Yes”. 2 Press ↑/↓ to select the channel you want to add. If you know the channel number, you can use the number buttons to directly select a channel. 3 Press +. Channels that are stored in the Favourite list are indicated by a ♥ symbol.
Turn off the Favourite list	Press RETURN.
Watch a channel	Press + while selecting a channel.
Add or remove channels in the Favourite list	<ol style="list-style-type: none"> 1 Press the blue button. Channels that are stored in the Favourite list are indicated by a ♥ symbol. 2 Press ↑/↓ to select the channel you want to add or remove. If you know the channel number, you can use the number buttons to directly select a channel. 3 Press +. 4 Press the blue button to return to the Favourite list.
Remove all channels from the Favourite list	<ol style="list-style-type: none"> 1 Press the blue button. 2 Press the yellow button. A display appears to confirm that you want to delete all channels from the Favourite list. 3 Press ↔ to select “Yes”, then press + to confirm.

Viewing pictures from connected equipment

Switch on the connected equipment, then perform one of the following operation.

For equipment connected to the scart sockets using a fully-wired 21-pin scart lead (page 35)



Start playback on the connected equipment.



















The picture from the connected equipment appears on the screen.

For an auto-tuned VCR (page 7)





In analogue mode, press PROG +/-, or the number buttons, to select the video channel.

For other connected equipment (page 34)

Press / repeatedly until the correct input symbol (see below) appears on the screen.

On screen display	Labels of input jacks
 AV1/2 or  AV1/2	 1/2 or  1/2
 AV3	 3 (Y, PB/CB, PR/CR) and  3 (L, R)
 AV4	HDMI IN 4 and HDMI IN 4  (L, R)
 AV5	HDMI IN 5
S-  AV6 or  AV6	S-  6 or  6, and  6 (L (MONO), R)
 PC	PC  and PC 

Additional operations

To	Do this
Return to normal TV mode	Press DIGITAL or ANALOG.
Access the Input signal index table (except for PC video input signal)	Press  to access the Input signal index table. (Then, only in analogue mode, press ) To select an input source, press  , then press  .

Using the Tools menu

Press TOOLS to display the following options when viewing pictures from connected equipment other than PC.

Options	Description
Close	Closes the Tools menu.
Power Saving	See page 26.
Picture Mode	See page 20.
Sound Mode	See page 22.
Auto Clock Set (in analogue mode only)	Allows you to switch to digital mode and obtain the time.
Sleep Timer	See page 25.
 Volume	Adjusts the volume of the headphones.

Using MENU Functions



Navigating through menus

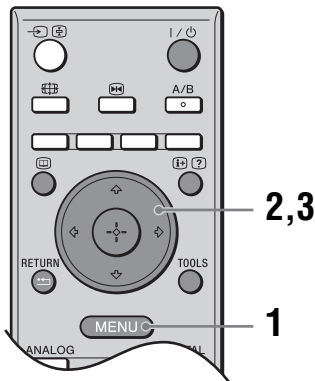

“MENU” allows you to enjoy various convenient features of this TV. You can easily select channels or inputs sources and change the settings for your TV.

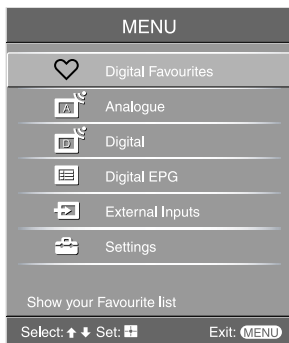

1 Press MENU to display the menu.



Icon	Description
	Digital Favourites Displays the Favourite list. For details about settings, see page 17.
	Analogue Returns to the last viewed analogue channel.
	Digital Returns to the last viewed digital channel.

Icon	Description
	Digital EPG Displays the Digital Electronic Programme Guide (EPG). For details about settings, see page 15.
	External Inputs Selects equipment connected to your TV. <ul style="list-style-type: none"> To watch the desired external input, select the input source, then press (+). To assign a label to an external input, select “Edit AV Labels”, then see page 25.
	Settings Displays the Settings menu where most of the advanced settings and adjustments are performed. For details about settings, see page 20 to 33. Note The options you can adjust vary depending on the situation. Unavailable options are greyed out or not displayed.

2 Press ↑/↓ to select an option.

3 Press (+) to confirm a selected option.
To exit the menu, press MENU.

Picture menu

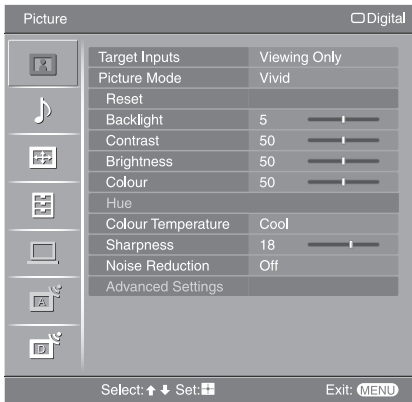

You can select the options listed below on the Picture menu.

- 1 Press \uparrow/\downarrow to select “Settings” on MENU, then press \oplus .
- 2 Press \uparrow/\downarrow to select a menu icon, then press \oplus .
- 3 Press $\uparrow/\downarrow/\leftarrow/\rightarrow$ to select an option.

Target Inputs

Selects whether to apply settings made in the Picture menu to all inputs, or only to the input currently being watched.

“All”: Applies settings to all inputs.

“Viewing Only”: Applies settings only to the current input.

Picture Mode

Selects the picture mode except for PC input source.

“Vivid”: For enhanced picture contrast and sharpness.

“Standard”: For standard picture. Recommended for home entertainment.

“Custom”: Allows you to store your preferred settings.

Display Mode

Selects the display mode for PC input source.

“Video”: For video images.

“Text”: For text, charts or tables.

Reset

Resets all picture settings except “Target Inputs”, “Picture Mode” and “Display Mode” to the factory settings.

Backlight

Adjusts the brightness of the backlight.

Tip

“Backlight” is not available when you set “Power Saving” to “High” (page 26).

Contrast

Increases or decreases picture contrast.

Brightness

Brightens or darkens the picture.

Colour

Increases or decreases colour intensity.

Hue

Increases or decreases the green tones and red tones.

Tip

“Hue” can only be adjusted for an NTSC colour signal (e.g., U.S.A. video tapes).

Colour Temperature	<p>Adjusts the whiteness of the picture.</p> <p>“Cool”: Gives the white colours a blue tint.</p> <p>“Neutral”: Gives the white colours a neutral tint.</p> <p>“Warm1”/“Warm2”: Gives the white colours a red tint. “Warm2” gives a redder tint than “Warm1”.</p> <p>Tip</p> <p>“Warm1” and “Warm2” can only be selected when you set “Picture Mode” to “Custom”.</p>
Sharpness	<p>Sharpens or softens the picture.</p>
Noise Reduction	<p>Reduces the picture noise (snowy picture) in a weak broadcast signal.</p> <p>“Auto”: Automatically reduces the picture noise (in analogue mode only).</p> <p>“High”/“Medium”/“Low”: Modifies the effect of the noise reduction.</p> <p>“Off”: Turns off the Noise Reduction feature.</p>
Advanced Settings	<p>Customizes the Picture function in more detail. When you set “Picture Mode” to “Custom”, you can set/change these settings.</p> <p>“Reset”: Resets all the advanced video settings to the factory settings.</p> <p>“Black Corrector”: Enhances black areas of the picture for stronger contrast.</p> <p>“Adv. Contrast Enhancer”: Automatically adjusts “Backlight” and “Contrast” to the most suitable settings judging from the brightness of the screen. This setting is especially effective for dark images scenes. It will increase the contrast distinction of the darker picture scenes.</p> <p>“Gamma”: Adjusts the balance between bright and dark areas of the picture.</p> <p>“Clear White”: Emphasizes white colours.</p> <p>“Live Colour”: Makes colours more vivid and reproduces clear skin tones.</p> <p>“Colour Space”: Changes the colour reproduction gamut. “Wide” reproduces the vivid colour and “Normal” reproduces the standard colour.</p> <p>“MPEG Noise Reduction”: Reduces the picture noise in MPEG-compressed video (in digital mode only).</p> <p>Tip</p> <p>“Live Colour” is not available when “Colour Space” is set to “Normal”.</p>

Sound menu

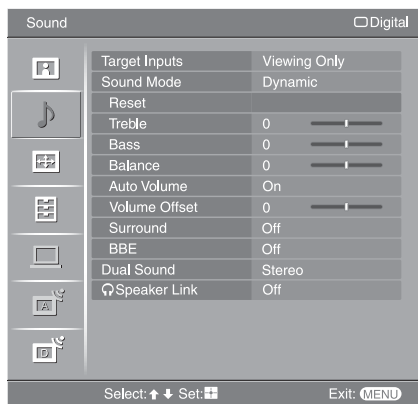

You can select the options listed below on the Sound menu. To select options in “Settings”, refer to “Picture menu” (page 20).

Target Inputs

Selects whether to apply settings made in the Sound menu to all inputs, or only to the input currently being watched.

“All”: Applies settings to all inputs.

“Viewing Only”: Applies settings only to the current input.

Sound Mode

Selects the sound mode.

“Dynamic”: Enhances treble and bass.

“Standard”: For standard sound. Recommended for home entertainment.

“Custom”: Flat response. Also allows you to store your preferred settings.

Reset

Resets the sound settings except “Sound Mode”, “Dual Sound” and “Speaker Link” to the factory settings.

Treble

Adjusts higher-pitched sounds.

Bass

Adjusts lower-pitched sounds.

Balance

Emphasizes left or right speaker balance.

Auto Volume

Keeps a constant volume level even when volume level gaps occur (e.g., adverts tend to be louder than programmes).

Volume Offset

Adjusts the volume level of the current input relative to other inputs, when “Target Inputs” is set to “Viewing Only”.

Surround

Selects the surround mode.

“TruSurround XT”: For surround sound (for stereo programmes only).

“Simulated Stereo”: Adds a surround-like effect to mono programs.

“Off”: For normal stereo or mono reception.

BBE

Gives sound more impact by compensating for phase effects in speakers using the “BBE High Definition Sound System”.

Dual Sound

Selects the sound from the speaker for a stereo or bilingual broadcast.

“Stereo”, “Mono”: For a stereo broadcast.

“A”/“B”/“Mono”: For a bilingual broadcast, select “A” for sound channel 1, “B” for sound channel 2, or “Mono” for a mono channel, if available.

Tip

If you select other equipment connected to the TV, set “Dual Sound” to “Stereo”, “A” or “B”.

Speaker Link (headphone speaker link)

Switches the TV’s internal speakers on/off when headphones are connected.

“On”: Sound is output only from headphones.

“Off”: Sound is output from both the TV and headphones.

Tip

“Treble”, “Bass”, “Balance”, “Auto Volume”, “Surround” and “BBE” cannot be used for headphones and audio output sockets.

Screen menu

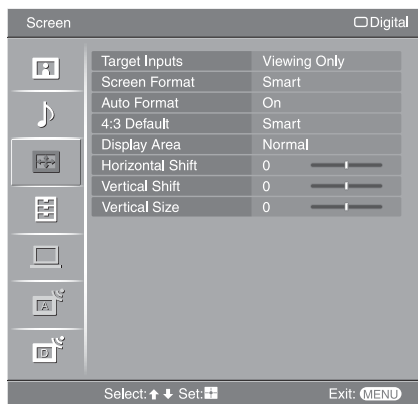

You can select the options listed below on the Screen menu. To select options in “Settings”, refer to “Picture menu” (page 20).

Target Inputs

Selects whether to apply settings made in the Screen menu to all inputs, or only to the input currently being watched.

“All”: Applies settings to all inputs.

“Viewing Only”: Applies settings only to the current input.

Screen Format

For details about the screen format, see “To change the screen format manually to suit the broadcast” (page 13).

Auto Format

Automatically changes the screen format according to the broadcast signal. To keep your setting, select “Off”.

Tips

- Even if you have selected “On” or “Off” in “Auto Format”, you can always modify the format of the screen by pressing **[F4]** repeatedly.
- “Auto Format” is available for PAL and SECAM signals only.

4:3 Default

Selects the default screen format for use with 4:3 broadcasts.

“Smart”: Displays conventional 4:3 broadcasts with an imitation wide screen effect.

“4:3”: Displays conventional 4:3 broadcasts in the correct proportions.

“Off”: Keeps the current “Screen Format” setting when the channel or input is changed.

Tip

This option is available only if “Auto Format” is set to “On”.

Display Area

Adjusts the screen area displaying the picture.

“Full Pixel”: Displays the picture for 1080i or 1080p sources in the original size when parts of the picture are cut off.

“Normal”: Displays the picture in the original size.

“-1”/“-2”: Enlarges the picture to hide the edge of the picture.

Horizontal Shift

Adjusts the horizontal position of the picture.

Vertical Shift

Adjusts the vertical position of the picture when the screen format is set to “Smart” (50 Hz), “Zoom” or “14:9”.

Vertical Size

Adjusts the vertical size of the picture when the screen format is set to “Smart”, “Zoom” or “14:9”.

Set-up menu

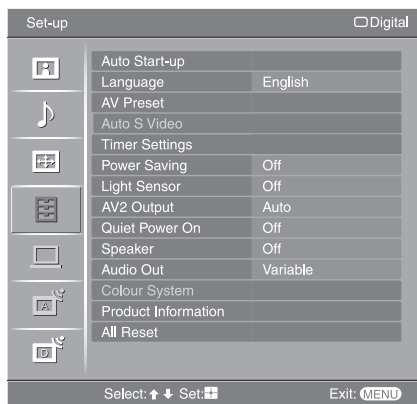

You can select the options listed below on the Set-up menu. To select options in “Settings”, refer to “Picture menu” (page 20).

Auto Start-up

Starts the “first time operation menu” to select the language and country/region, and tune in all available digital and analogue channels. Usually, you do not need to do this operation because the language and country/region will have been selected and channels already tuned when the TV was first installed (page 6, 7). However, this option allows you to repeat the process (e.g., to retune the TV after moving house, or to search for new channels that have been launched by broadcasters).

Language

Selects the language in which the menus are displayed.

AV Preset

Assigns a name to any equipment connected to the side and rear sockets. The name will be displayed briefly on the screen when the equipment is selected. You can skip an input source that is not necessary.

- 1 Press \uparrow/\downarrow to select the desired input source, then press \oplus .
- 2 Press \uparrow/\downarrow to select the desired option below, then press \oplus .
Equipment labels: Uses one of the preset labels to assign a name to connected equipment.
“Edit:”: Creates your own label. Follow steps 2 to 4 of “Programme Labels” (page 29).
“Skip”: Skips an unnecessary input source when you press \rightarrow to select the input source.

Auto S Video

Selects the input signal from S video sockets S- \rightarrow 6 when S- \rightarrow 6/ \rightarrow 6 sockets are both connected.

Timer Settings

Sets the timer to turn on/off the TV.

Sleep Timer

Sets a period of time after which the TV automatically switches itself into standby mode.

When the Sleep Timer is activated, the \downarrow (Timer) indicator on the TV (front) lights up in orange.

Tips

- If you switch off the TV and switch it on again, “Sleep Timer” is reset to “Off”.
- “TV will soon turn off by Sleep Timer” appears on the screen one minute before the TV switches to standby mode.

Continued

On Timer

Sets the timer to turn on the TV from standby mode.

“Day”: Selects the day on which you want to activate the On Timer.

“Time”: Sets the time to turn on the TV.

“Duration”: Selects the time period after which the TV automatically switches to standby mode again.

“Volume Set-up”: Sets the volume for when the timer turns on the TV.

Clock Set

Allows you to adjust the clock manually. When the TV is receiving digital channels, the clock cannot be adjusted manually since it is set to the time code of the broadcasted signal.

Power Saving

Selects the power saving mode to reduce the power consumption of the TV.

When “Picture Off” is selected, the picture is switched off and the  (Picture Off) indicator on the TV (front) lights up in green. The sound remains unchanged.

Light Sensor



“On”: Automatically optimizes the picture settings according to the ambient light in the room.

“Off”: Turns off the “Light Sensor” feature.

Note

Be sure not to put anything over the sensor, as its function may be affected. See page 11 for further information on the sensor.





AV2 Output

Sets a signal to be output through the socket labelled  2 on the rear of the TV. If you connect a VCR or other recording equipment to the  2 socket, you can then record from the equipment connected to other sockets of the TV.

“TV”: Outputs a broadcast.

“AV1”: Outputs signals from equipment connected to the  1 socket.

“AV6”: Outputs signals from equipment connected to the  6 socket.

“Auto”: Outputs whatever is being viewed on the screen (except signals from the , ,  3, HDMI IN 4, HDMI IN 5 and PC  sockets).

Quiet Power On

Sets the volume control at a low level when the TV is first turned on, gradually increasing the sound to a preset level.

Speaker

Switches on/off the TV’s internal speakers.

“On”: The TV speakers are turned on in order to listen to the TV’s sound through TV’s speakers.

“Off”: The TV speakers are turned off in order to listen to the TV’s sound only through your external audio equipment connected to the audio output sockets.

Audio Out

“Variable”: The audio output from your audio system can be controlled by the TV’s remote.

“Fixed”: The audio output of the TV is fixed. Use your audio receiver’s volume control to adjust the volume (and other audio settings) through your audio system.

Colour System

Selects the colour system (“Auto”, “PAL”, “SECAM”, “NTSC3.58”, “NTSC4.43”, or “PAL60”) according to the input signal from the input source.

Product Information

Displays your TV’s system information.

All Reset

Resets all settings to the factory settings and then displays the Auto Start-up screen.

Note

All settings, including Digital Favourite list, country, language, auto tuned channels, etc. will be reset.

PC Settings menu

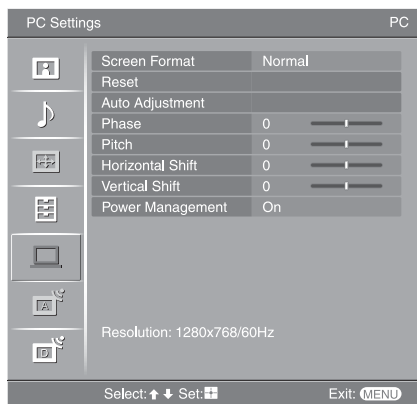

You can select the options listed below on the PC Settings menu. To select options in “Settings”, refer to “Picture menu” (page 20).

Screen Format

Selects a screen format for displaying input from your PC.

“Normal”: Displays the picture in its original size.

“Full1”: Enlarges the picture to fill the display area, keeping its original horizontal-to-vertical aspect ratio.

“Full2”: Enlarges the picture to fill the display area.

Reset

Resets the PC settings except “Screen Format” and “Power Management” to the factory settings.

Auto Adjustment

Automatically adjusts the display position and phase of the picture when the TV receives an input signal from the connected PC.

Tip

Auto Adjustment may not work well with certain input signals. In such cases, manually adjust “Phase”, “Pitch”, “Horizontal Shift” and “Vertical Shift”.

Phase

Adjusts the phase when the screen flickers.

Pitch

Adjusts the pitch when the picture has unwanted vertical stripes.

Horizontal Shift

Adjusts the horizontal position of the picture.

Vertical Shift

Adjusts the vertical position of the picture.

Power Management

Switches the TV to standby mode if no signal is received for 30 seconds.

Analogue Set-up menu (Analogue mode only)

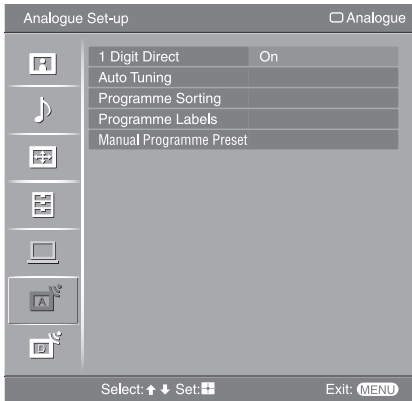

You can change/set the analogue settings using the Analogue Set-up menu. To select options in “Settings”, refer to “Picture menu” (page 20).

1 Digit Direct

When “1 Digit Direct” is set to “On”, you can select an analogue channel using one preset number button (0 - 9) on the remote.

Note

When “1 Digit Direct” is set to “On”, you cannot select channel numbers 10 and above entering two digits using the remote.

Auto Tuning

Tunes in all the available analogue channels.

Usually you do not need to do this operation because the channels are already tuned when the TV was first installed (page 7). However, this option allows you to repeat the process (e.g., to retune the TV after moving house, or to search for new channels that have been launched by broadcasters).

Programme Sorting

Changes the order in which the analogue channels are stored on the TV.

- 1 Press \uparrow/\downarrow to select the channel you want to move to a new position, then press \oplus .
- 2 Press \uparrow/\downarrow to select the new position for your channel, then press \oplus .

Programme Labels

Assigns a channel name of your choice up to five letters or numbers. The name will be displayed briefly on the screen when the channel is selected. (Names for channels are usually taken automatically from Analogue Text (if available).)

- 1 Press \uparrow/\downarrow to select the channel you want to name, then press \oplus .
- 2 Press \uparrow/\downarrow to select the desired letter or number (“_” for a blank space), then press \Rightarrow .

If you input a wrong character

Press \Leftarrow/\Rightarrow to select the wrong character. Then, press \uparrow/\downarrow to select the correct character.

To delete all the characters

Select “Reset”, then press \oplus .

- 3 Repeat the procedure in step 2 until the name is complete.
- 4 Select “OK”, then press \oplus .

Continued

Manual Programme Preset

Before selecting “Label”/“AFT”/“Audio Filter”/“Skip”/“Decoder”, press PROG +/- to select the programme number with the channel. You cannot select a programme number that is set to skip (page 31).

Programme/System/Channel

Presets programme channels manually.

- 1 Press \uparrow/\downarrow to select “Programme”, then press \oplus .
- 2 Press \uparrow/\downarrow to select the programme number you want to manually tune (if tuning a VCR, select channel 00), then press RETURN.
- 3 Press \uparrow/\downarrow to select “System”, then press \oplus .
- 4 Press \uparrow/\downarrow to select one of the following TV broadcast systems, then press \leftarrow .
B/G: For western European countries/regions
D/K: For eastern European countries/regions
L: For France
I: For the United Kingdom
- 5 Press \uparrow/\downarrow to select “Channel”, then press \oplus .
- 6 Press \uparrow/\downarrow to select “S” (for cable channels) or “C” (for terrestrial channels), then press \rightleftarrows .

Note

“S” is not available when “United Kingdom” is selected for “Country” (page 6).

- 7 Tune the channels as follows:

If you do not know the channel number (frequency)

Press \uparrow/\downarrow to search for the next available channel. When a channel has been found, the search will stop. To continue searching, press \uparrow/\downarrow .

If you know the channel number (frequency)

Press the number buttons to enter the channel number of the broadcast you want or your VCR channel number.

- 8 Press \oplus to jump to “Confirm”, then press \oplus .
- 9 Press \downarrow to select “OK”, then press \oplus .

Repeat the procedure above to preset other channels manually.

Label

Assigns a name of your choice, up to five letters or numbers, to the selected channel. This name will be displayed briefly on the screen when the channel is selected. To input characters, follow steps 2 to 4 of “Programme Labels” (page 29).

AFT

Allows you to fine-tune the selected programme number manually if you feel that a slight tuning adjustment will improve the picture quality.

You can adjust the fine tuning over a range of -15 to +15. When “On” is selected, the fine tuning is performed automatically.

Audio Filter

Improves the sound for individual channels in the case of distortion in mono broadcasts. Sometimes a non-standard broadcast signal can cause sound distortion or intermittent sound muting when watching mono programmes.

If you do not experience any sound distortion, we recommend that you leave this option set to the factory setting “Off”.



Notes

- You cannot receive stereo or dual sound when “Low” or “High” is selected.
- “Audio Filter” is not available when “System” is set to “L”.

Skip

Skips unused analogue channels when you press PROG +/- to select channels. (You can still select a skipped channel using the number buttons.)

Decoder

Views and records the scrambled channel selected when using a decoder connected directly to scart connector  1, or to scart connector  2 via a VCR.

Note

This option is not available when “United Kingdom” is selected for “Country” (page 6).

Confirm

Saves changes made to the “Manual Programme Preset” settings.

Digital Set-up menu DV3

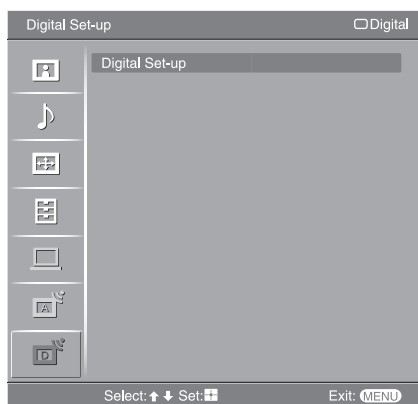

You can change/set the digital settings using the Digital Set-up menu. Select “Digital Set-up” and press \oplus to display the following menus. To select options in “Settings”, refer to “Picture menu” (page 20).

Digital Tuning

Displays the “Digital Tuning” menu.

Digital Auto Tuning

Tunes in all the available digital channels.

Usually you do not need to do this operation because the channels are already tuned when the TV was first installed (page 7). However, this option allows you to repeat the process (e.g., to retune the TV after moving house, or to search for new channels that have been launched by broadcasters).

Programme List Edit

Removes any unwanted digital channels stored on the TV, and changes the order of the digital channels stored on the TV.

- 1 Press \uparrow/\downarrow to select the channel you want to remove or move to a new position.

If you know the programme number (frequency)

Press the number buttons to enter the three-digit programme number of the broadcast you want.

- 2 Remove or change the order of the digital channels as follows:

To remove the digital channel

Press \oplus . A message that confirms whether the selected digital channel is to be deleted appears. Press \leftarrow to select “Yes”, then press \oplus .

To change the order of the digital channels

Press \Rightarrow , then press \uparrow/\downarrow to select the new position for the channel and press \leftarrow . Repeat the procedure in steps 1 and 2 to move other channels if required.

- 3 Press RETURN.

Digital Manual Tuning

Tunes the digital channels manually.

- 1 Press the number button to select the channel number you want to manually tune, then press \uparrow/\downarrow to tune the channel.
- 2 When the available channels are found, press \uparrow/\downarrow to select the channel you want to store, then press \oplus .
- 3 Press \uparrow/\downarrow to select the programme number where you want to store the new channel, then press \oplus .

Repeat the procedure above to tune other channels manually.

Digital Set-up

Displays the “Digital Set-up” menu.

Subtitle Setting*

Displays digital subtitles on the screen.

When “For Hard Of Hearing” is selected, some visual aids may also be displayed with the subtitles (if TV channels broadcast such information).

Subtitle Language*

Selects which language subtitles are displayed in.

Audio Language*

Selects the language used for a programme. Some digital channels may broadcast several audio languages for a programme.

Audio Type*

Increases the sound level when “For Hard Of Hearing” is selected.

Parental Lock*

Sets an age restriction for programmes. Any programme that exceeds the age restriction can only be watched after a PIN Code is entered correctly.

- 1 Press the number buttons to enter your existing PIN code.
If you have not previously set a PIN, a PIN code entry screen appears. Follow the instruction of “PIN Code” below.
- 2 Press \uparrow/\downarrow to select the age restriction or “None” (for unrestricted watching), then press \oplus .
- 3 Press RETURN.

PIN Code*

Sets a PIN code for the first time, or allows you to change your PIN code.

- 1 Enter a PIN as follows:
If you have previously set a PIN
Press the number buttons to enter your existing PIN.
If you have not set a PIN
Press the number buttons to enter the factory setting PIN of 9999.
- 2 Press the number buttons to enter the new PIN code.
A message appears to inform you that the new PIN has been accepted.
- 3 Press RETURN.

Tip

PIN code 9999 is always accepted.

Technical Set-up

Displays the Technical Set-up menu.

“Auto Service Update”: Enables the TV to detect and store new digital services as they become available.

“Software Download”: Enables the TV to automatically receive software updates, free through your existing aerial (when issued). Sony recommends that this option is set to “On” at all times. If you do not want your software to be updated, set this option to “Off”.

“System Information”: Displays the current software version and the signal level.

“Time Zone”: Allows you to manually select the time zone you are in, if it is not the same as the default time zone setting for your country.

CA Module Set-up

Allows you to access a Pay Per View service once you obtain a Conditional Access Module (CAM) and a view card. See page 34 for the location of the  (PCMCIA) socket.

* This function may not be available in some countries.

Connecting optional equipment

You can connect a wide range of optional equipment to your TV. Connecting cables are not supplied.

Connecting to the TV (side)

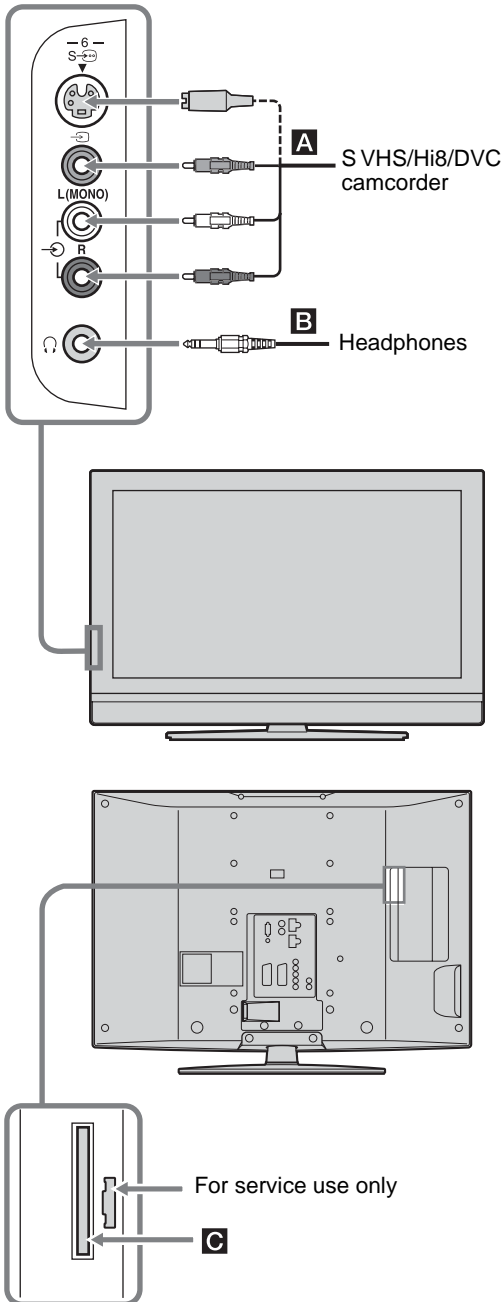

To connect	Do this
S VHS/Hi8/DVC camcorder A	Connect to the S video socket S → 6 or the composite video socket → 6, and the audio L (MONO)/R sockets → 6. To avoid picture noise, do not connect the camcorder to the video socket → 6 and the S video socket S → 6 at the same time. If you connect mono equipment, connect to the L socket → 6.
Headphones B	Connect to the ♪ socket to listen to sound from the TV on headphones.
Conditional Access Module (CAM) C	To use Pay Per View services. For details, refer to the instruction manual supplied with your CAM. To use the CAM, remove the rubber cover from the CAM slot. Switch off the TV when inserting your CAM into the CAM slot. When you do not use the CAM, we recommend that you replace the cover on the CAM slot. Note CAM is not supported in all countries. Please check with your authorized dealer.

Connecting to the TV (rear)

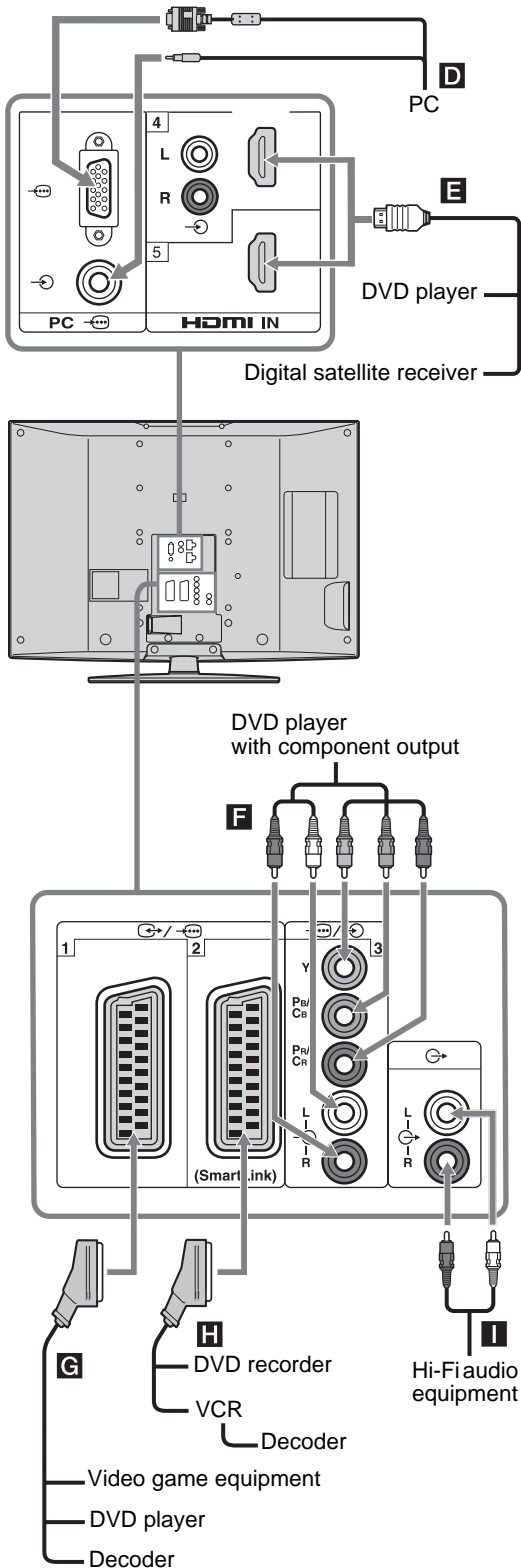

To connect

Do this

PC **D**

Connect to the PC sockets. It is recommended to use a PC cable with ferrites.

Digital satellite receiver or DVD player **E**

Connect to the HDMI IN 4 or 5 socket if the equipment has a HDMI socket. The digital video and audio signals are input from the equipment. If the equipment has a DVI socket, connect the DVI socket to the HDMI IN 4 socket through a DVI - HDMI adaptor interface (not supplied), and connect the equipment's audio out sockets to the audio in HDMI IN 4 sockets.

Notes

- The HDMI sockets only support the following video inputs: 480i, 480p, 576i, 576p, 720p, 1080i and 1080p. To connect a PC, please use the PC socket.
- Be sure to use only an HDMI cable that bears the HDMI logo.

DVD player with component output **F**

Connect to the component video sockets and the audio L/R sockets 3.

Video game equipment **G**

Connect to the scart socket 1. When you connect the decoder, the scrambled signal from the TV tuner is output to the decoder, then the unscrambled signal is output from the decoder.

DVD recorder or VCR that supports SmartLink **H**

Connect to the scart socket 2. SmartLink is a direct link between the TV and a VCR/DVD recorder.

Hi-Fi audio equipment **I**

Connect to the audio output sockets to listen to the sound from the TV on Hi-Fi audio equipment.

Using the Tools menu in PC input mode

Press TOOLS to display the following options when viewing pictures input from the connected PC.

Options	Description
Close	Closes the Tools menu.
Power Saving	See page 26.
Display Mode	See page 20.
Sound Mode	See page 22.
Auto Adjustment	See page 28.
Horizontal Shift	See page 28.
Vertical Shift	See page 28.
Auto Clock Set (in analogue mode only)	Allows you to switch to digital mode and obtain the time.
 Volume	Adjusts the volume of the headphones.

Specifications

Display Unit

Power Requirements:

220–240 V AC, 50 Hz

Screen Size:

KDL-46T35xx:

46 inches (Approx. 116.8 cm measured diagonally)

KDL-40xxxxx:

40 inches (Approx. 101.6 cm measured diagonally)

Display Resolution:

1,920 dots (horizontal) × 1,080 lines (vertical)

Power Consumption:

KDL-46T35xx: 225 W

KDL-40xxxxx: 185 W

Standby Power Consumption*:

0.3 W

* Specified standby power is reached after the TV finishes necessary internal processes.

Dimensions (w × h × d):

KDL-46T35xx:

Approx. 1,126 × 805 × 334 mm (with stand)

Approx. 1,126 × 755 × 116 mm (without stand)

KDL-40xxxxx:

Approx. 988 × 716 × 265 mm (with stand)

Approx. 988 × 664 × 103 mm (without stand)

Mass:

KDL-46T35xx:

Approx. 34.0 kg (with stand)

Approx. 28.5 kg (without stand)

KDL-40xxxxx:

Approx. 26.0 kg (with stand)

Approx. 22.0 kg (without stand)

Panel System

LCD (Liquid Crystal Display) Panel

TV System

Depending on your country/region selection

Analogue: B/G/H, D/K, L, I

Digital: DVB-T

Colour/Video System

Analogue: PAL, SECAM

NTSC 3.58, 4.43 (only Video In)

Digital: MPEG-2 MP@ML

Aerial

75 ohm external terminal for VHF/UHF

Channel Coverage

Analogue: 48.25 - 855.25 MHz

Digital: VHF Band III (177.5 - 226.5 MHz)

UHF E21 - E69 (474 - 858 MHz)

Terminals

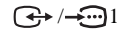

21-pin Scart connector (CENELEC standard) including audio/video input, RGB input, and TV audio/video output.

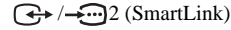

21-pin Scart connector (CENELEC standard) including audio/video input, RGB input, selectable audio/video output, and SmartLink interface.



Supported formats: 1080i, 720p, 576p, 576i, 480p, 480i

Y: 1 V_{p-p}, 75 ohms, 0.3V negative sync

P_{B/CB}: 0.7 V_{p-p}, 75 ohms

P_{R/CR}: 0.7 V_{p-p}, 75 ohms



Audio input (phono jacks)

500 mVrms

Impedance: 47 kilohms

HDMI IN 4, 5

Video: 1080p, 1080i, 720p, 576p, 576i, 480p, 480i

Audio: Two channel linear PCM

32, 44.1 and 48 kHz, 16, 20 and 24 bits

Analogue audio (phono jacks):

500 mVrms, Impedance 47 kilohms

(HDMI IN 4 only)

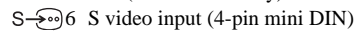

S video input (4-pin mini DIN)



Video input (phono jack)



Audio input (phono jacks)



Audio output (phono jacks)



PC Input (D-sub 15-pin) (see page 38)

G: 0.7 V_{p-p}, 75 ohms, non Sync on Green

B: 0.7 V_{p-p}, 75 ohms

R: 0.7 V_{p-p}, 75 ohms

HD: 1-5 V_{p-p}

VD: 1-5 V_{p-p}



PC audio input (minijack)



Headphones jack



CAM (Conditional Access Module) slot

Sound Output

10 W + 10 W

Supplied Accessories

Refer to “1: Checking the accessories” on page 4.

Optional Accessories

- Wall-Mount Bracket SU-WL51

Design and specifications are subject to change without notice.

PC Input Signal Reference Chart

Signals	Horizontal (Pixel)	Vertical (Line)	Horizontal frequency (kHz)	Vertical frequency (Hz)	Standard
VGA	640	480	31.5	60	VGA
	640	480	37.5	75	VESA
	720	400	31.5	70	VGA-T
SVGA	800	600	37.9	60	VESA Guidelines
	800	600	46.9	75	VESA
XGA	1024	768	48.4	60	VESA Guidelines
	1024	768	56.5	70	VESA
	1024	768	60	75	VESA
WXGA	1280	768	47.4	60	VESA
	1280	768	47.8	60	VESA
	1360	768	47.7	60	VESA



- This TV's PC input does not support Sync on Green or Composite Sync.
- This TV's PC input does not support interlaced signals.
- For the best picture quality, it is recommended to use the signals (boldfaced) in the above chart with a 60 Hz vertical frequency from a personal computer. In plug and play, signals with a 60 Hz vertical frequency will be selected automatically.

Troubleshooting

Check whether the  (standby) indicator is flashing in red.

When it is flashing









The self-diagnosis function is activated.

- 1 Count how many  (standby) indicator flashes between each two second break.
For example, the indicator flashes three times, then there is a two second break, followed by another three flashes, etc.
- 2 Press  on the TV (Top side) to switch it off, disconnect the mains lead, and inform your dealer or Sony service centre of how the indicator flashes (number of flashes).

When it is not flashing

- 1 Check the items in the tables below.
- 2 If the problem still persists, have your TV serviced by qualified service personnel.

Picture

Problem	Cause/Remedy
No picture (screen is dark) and no sound	<ul style="list-style-type: none"> • Check the aerial connection. • Connect the TV to the mains, and press  on the TV (top side). • If the  (standby) indicator lights up in red, press .
No picture or no menu information from equipment connected to the scart connector	<ul style="list-style-type: none"> • Check that the optional equipment is on and press / repeatedly until the correct input symbol is displayed on the screen. • Check the connection between the optional equipment and the TV.
Double images or ghosting	<ul style="list-style-type: none"> • Check aerial/cable connections. • Check the aerial location and direction.
Only snow and noise appear on the screen	<ul style="list-style-type: none"> • Check if the aerial is broken or bent. • Check if the aerial has reached the end of its serviceable life (three to five years in normal use, one to two years at the seaside).
Distorted picture (dotted lines or stripes)	<ul style="list-style-type: none"> • Keep the TV away from electrical noise sources such as cars, motorcycles, hair-dryers or optical equipment. • When installing optional equipment, leave some space between the optional equipment and the TV. • Make sure that the aerial is connected using the supplied coaxial cable. • Keep the aerial cable away from other connecting cables.
Picture noise when viewing a TV channel	<ul style="list-style-type: none"> • Select “Manual Programme Preset” in the “Analogue Set-up” menu and adjust “AFT” (Automatic Fine Tuning) to obtain better picture reception (page 30).
Some tiny black points and/or bright points on the screen	<ul style="list-style-type: none"> • The picture of a display unit is composed of pixels. Tiny black points and/or bright points (pixels) on the screen do not indicate a malfunction.
No colour on programmes	<ul style="list-style-type: none"> • Select “Reset” in the “Picture” menu to return to the factory settings (page 20).
No colour or irregular colour when viewing a signal from the Y, Pb/Cb, Pr/Cr jacks of  3	<ul style="list-style-type: none"> • Check the connection of the Y, Pb/Cb, Pr/Cr jacks of 3. • Make sure that the Y, Pb/Cb, Pr/Cr jacks of 3 are firmly seated in their respective sockets.

Continued

Sound

Problem	Cause/Remedy
No sound, but good picture	<ul style="list-style-type: none">• Press \triangle +/- or \times (Mute).• Check that “Speaker” is set to “On” in the “Set-up” menu (page 26).
Noisy sound	<ul style="list-style-type: none">• See the “Picture noise” causes/remedies on page 39.

Channels

Problem	Cause/Remedy
The desired channel cannot be selected	<ul style="list-style-type: none">• Switch between digital and analogue mode and select the desired digital/analogue channel.
Some channels are blank	<ul style="list-style-type: none">• Scrambled/Subscription only channel. Subscribe to the Pay Per View service.• Channel is used only for data (no picture or sound).• Contact the broadcaster for transmission details.
Digital channel is not displayed	<ul style="list-style-type: none">• Contact a local installer to find out if digital transmissions are provided in your area.• Upgrade to a higher gain aerial.

General

Problem	Cause/Remedy
The TV turns off automatically (the TV enters standby mode)	<ul style="list-style-type: none">• Check if the “Sleep Timer” is activated, or confirm the “Duration” setting of “On Timer” (page 25).• If no signal is received and no operation is performed in the TV mode for 10 minutes, the TV automatically switches to standby mode.
The TV turns on automatically	<ul style="list-style-type: none">• Check if the “On Timer” is activated (page 26).
Some input sources cannot be selected	<ul style="list-style-type: none">• Select “AV Preset” in the “Set-up” menu and cancel “Skip” of the input source (page 25).
The remote does not function	<ul style="list-style-type: none">• Replace the batteries.

<http://www.sony.net/>

KDL-46T35xx
KDL-40T35xx
KDL-40V29xx

3-281-522-11(1)

Printed in Spain